

Ficha para inicial - 3 años

Autor: Jennifer Germosen

Fecha: | |

Lógico matemática

Conteo de el número 4

Cuenta la cantidad de peces que hay en cada pecera. Luego, colorea el grupo que tiene 4 peces.

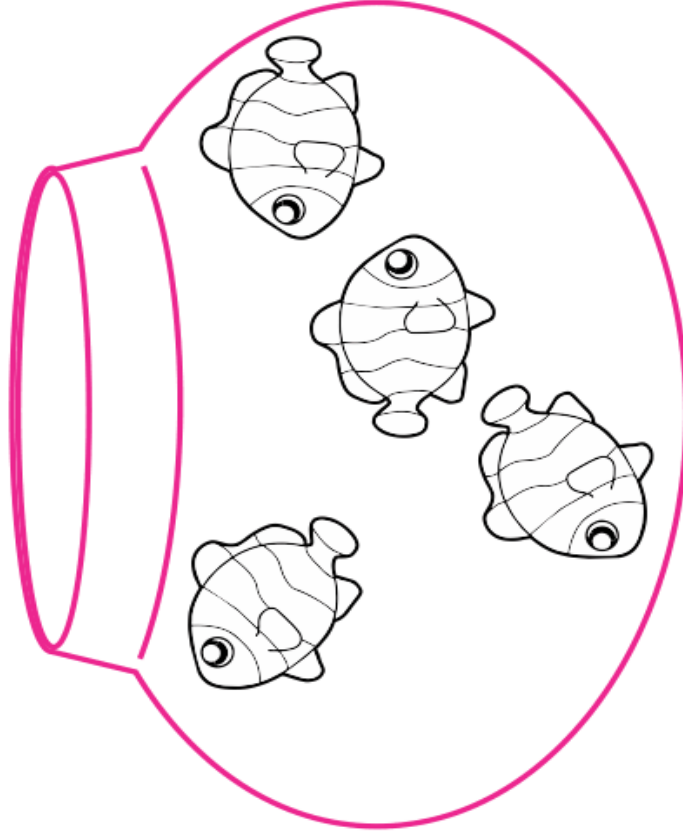
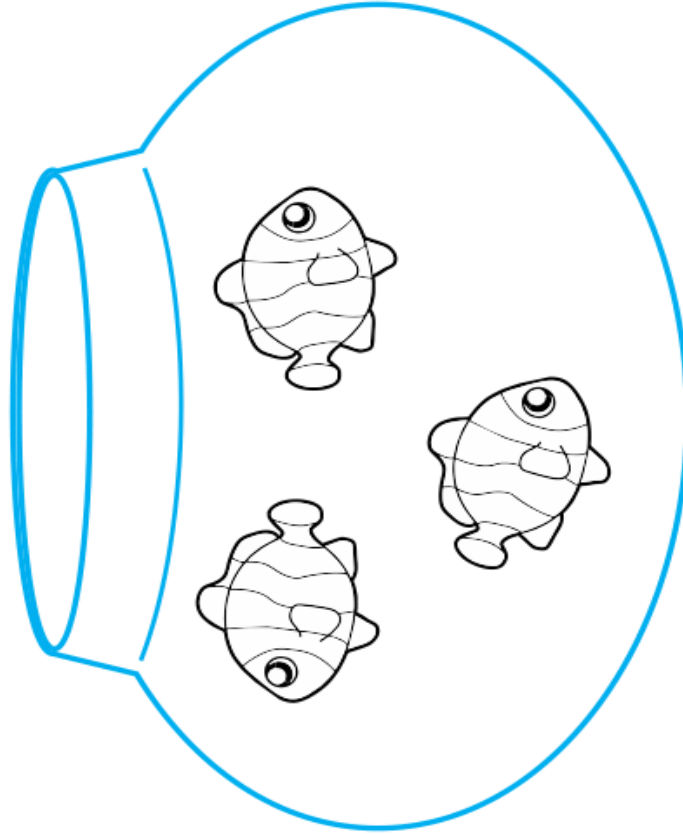

NOMBRE

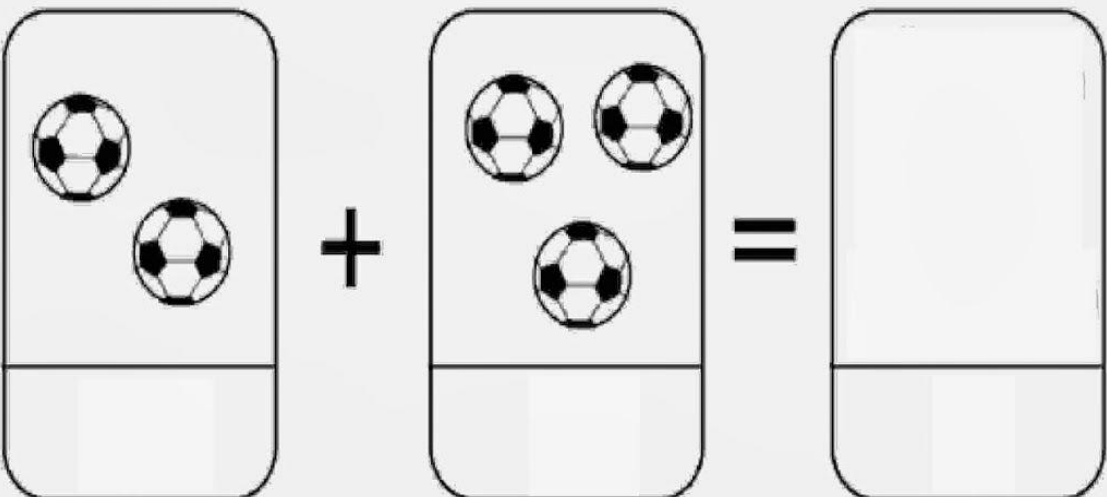
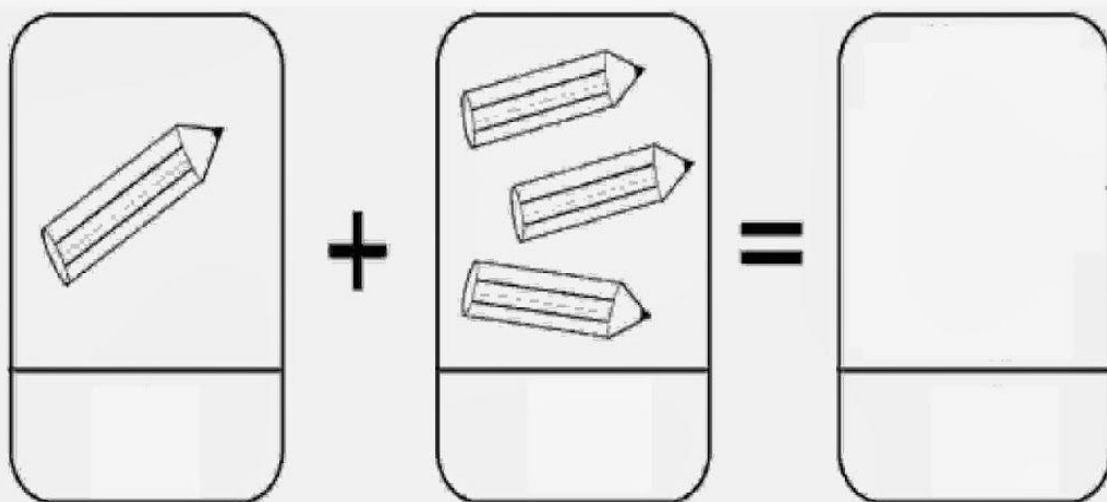
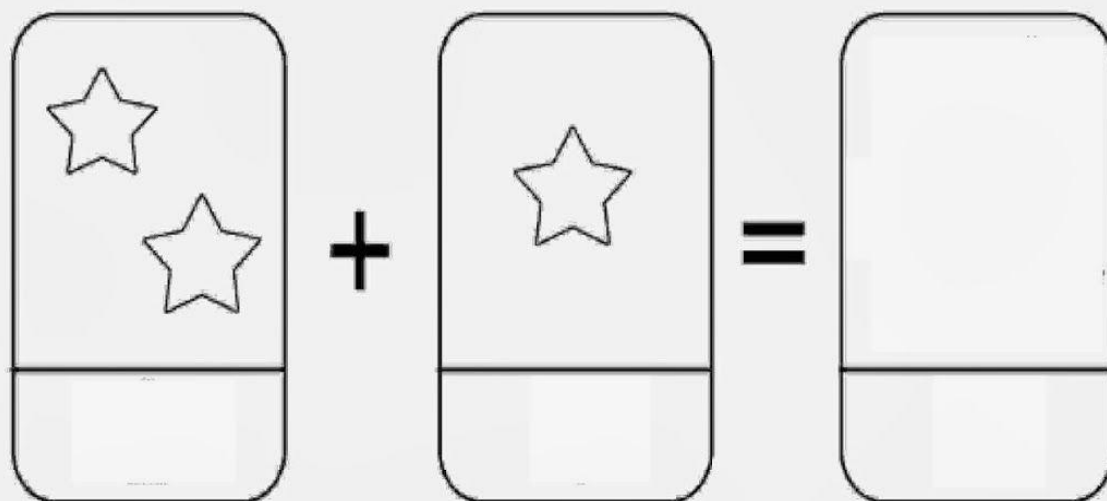

¿Cuántos hay? Une los dibujos con su número.

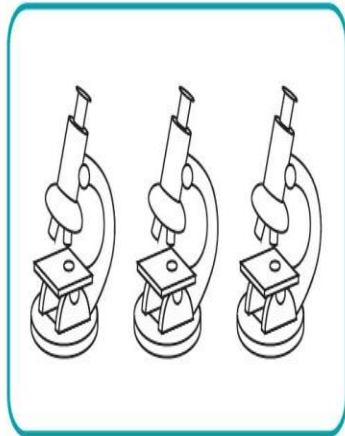
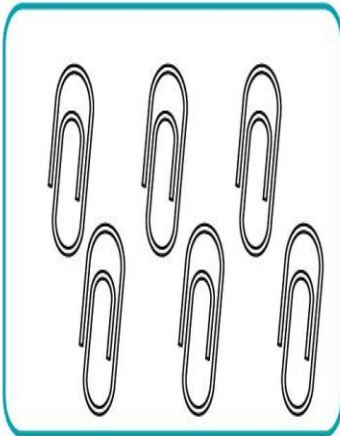

1

2

3

4





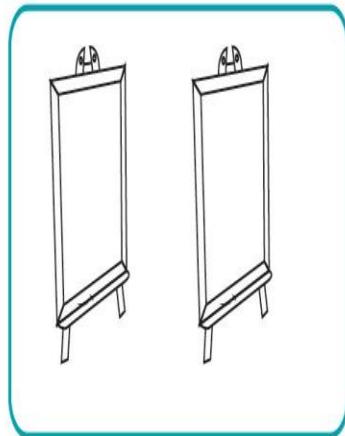
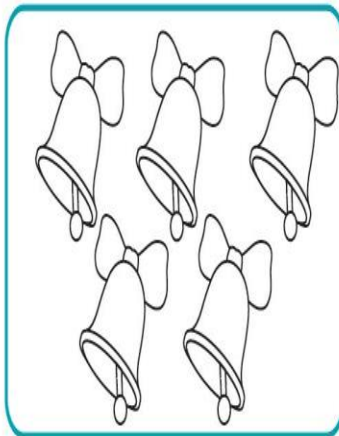
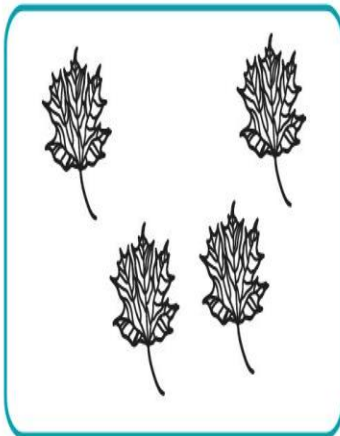



















5

6















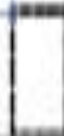







NOMBRE:

● Colorea tantas banderas de cada fila y color como indica su número.

1						0/6	
2						0/6	
3						0/6	
4						0/6	

© Copyright - www.mislibrosgratis.com

● Continúa las series.

Nombre: _____

Fecha: _____

Cuadernillo 1
Lógico Matemática 4 años



Trayectoria

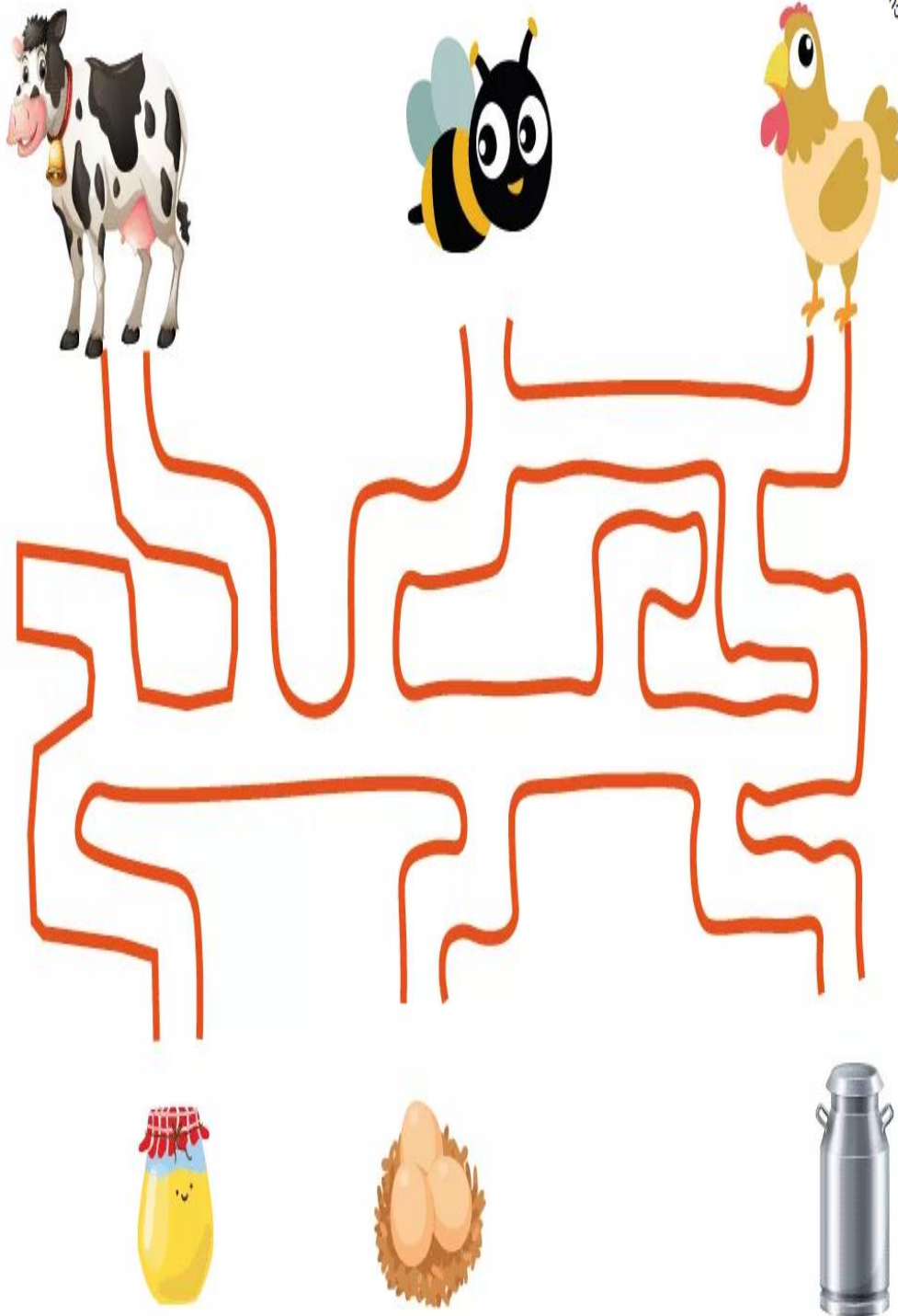



Copyright © www.materialeaprendizaje.com

Observa y comenta: ¿Qué animales ves? ¿Los habías visto antes? ¿Qué alimentos obtenemos de cada uno de ellos?
Con tu dedo índice descubre el camino de el alimento que obtenemos de estos animales, luego traza con plumones de colores.

NOMBRE

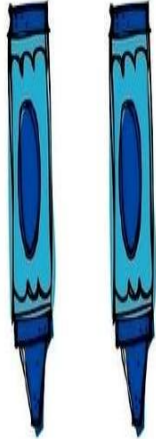
Cuenta cuántos hay y colorea el número.

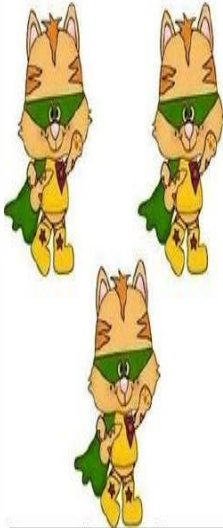
	
3 2 1	4 3 2

	
3 5 4	5 4 6

NOMBRE

Cuenta cuántos hay y colorea el número.

	2 3 4
--	-------

	6 5 3
---	-------

	4 2 3
--	-------

	5 4 3
--	-------

	2 4 5
--	-------

Número 4

Capacidad: Identifica y establece en colecciones de objetos la relación entre el número y la cantidad.

1. Traza el número 4; luego, forma conjuntos de cuatro elementos y píntalos. Finalmente, completa el recuadro:

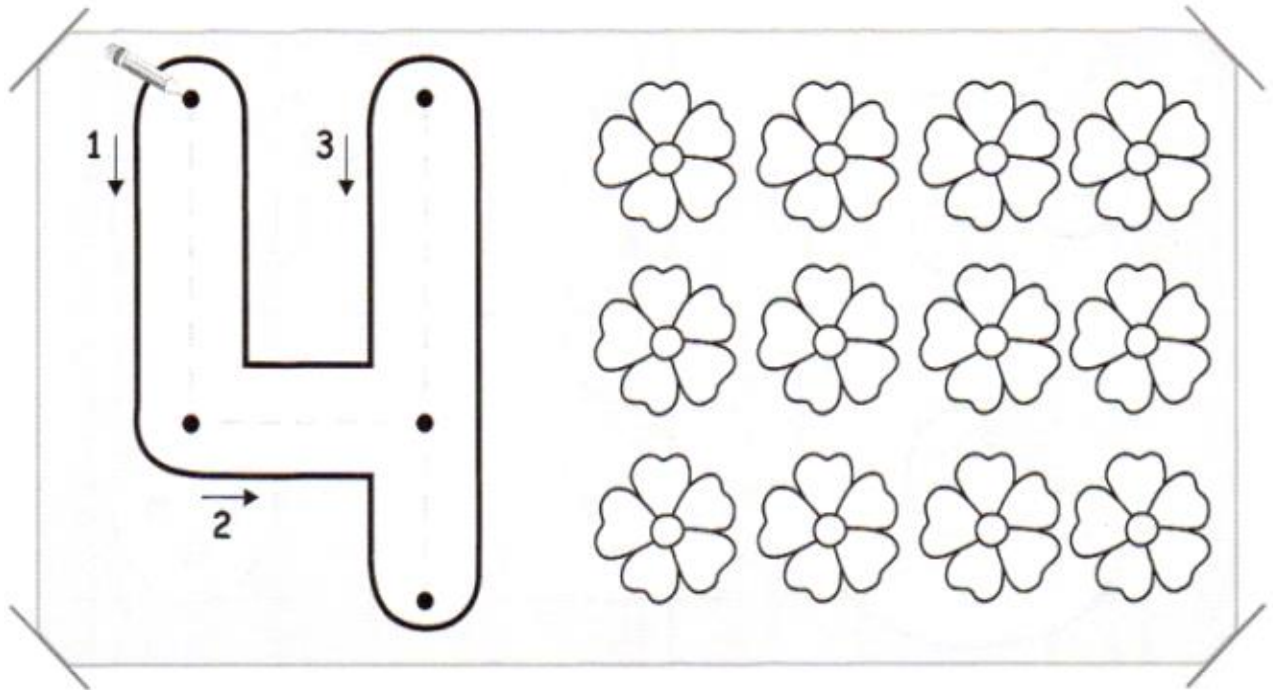

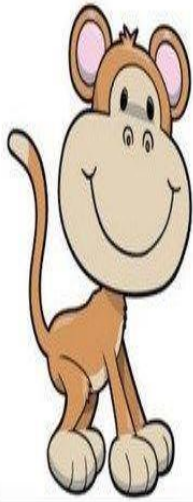

NOMBRE: _____

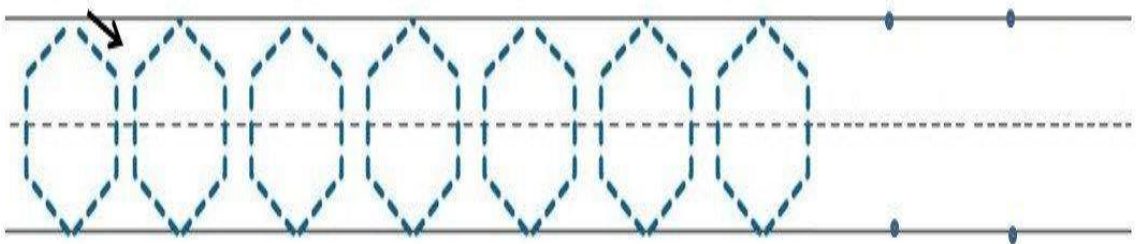
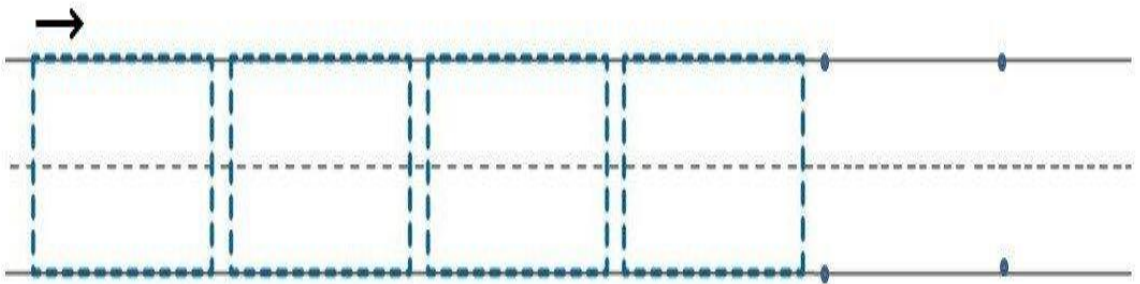
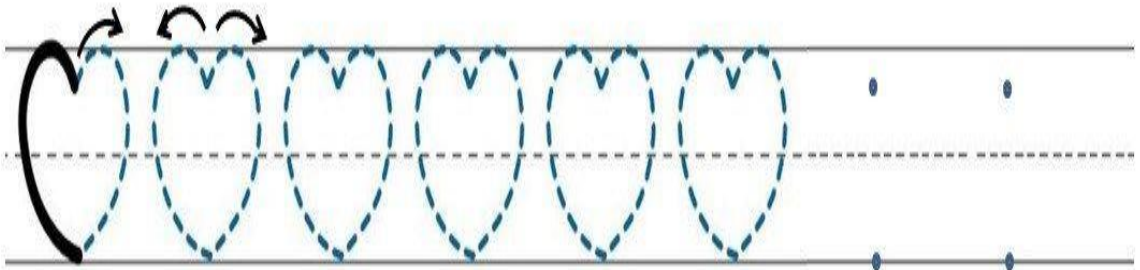
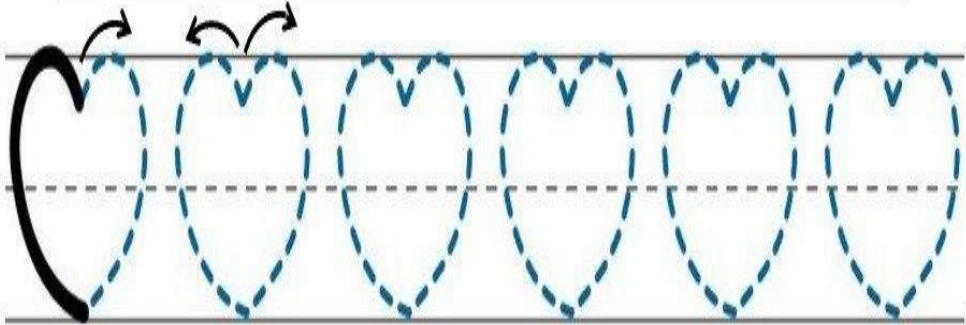

Repasa y continúa las figuras.

Iguales

😊 Pinta las mariposas que son iguales.

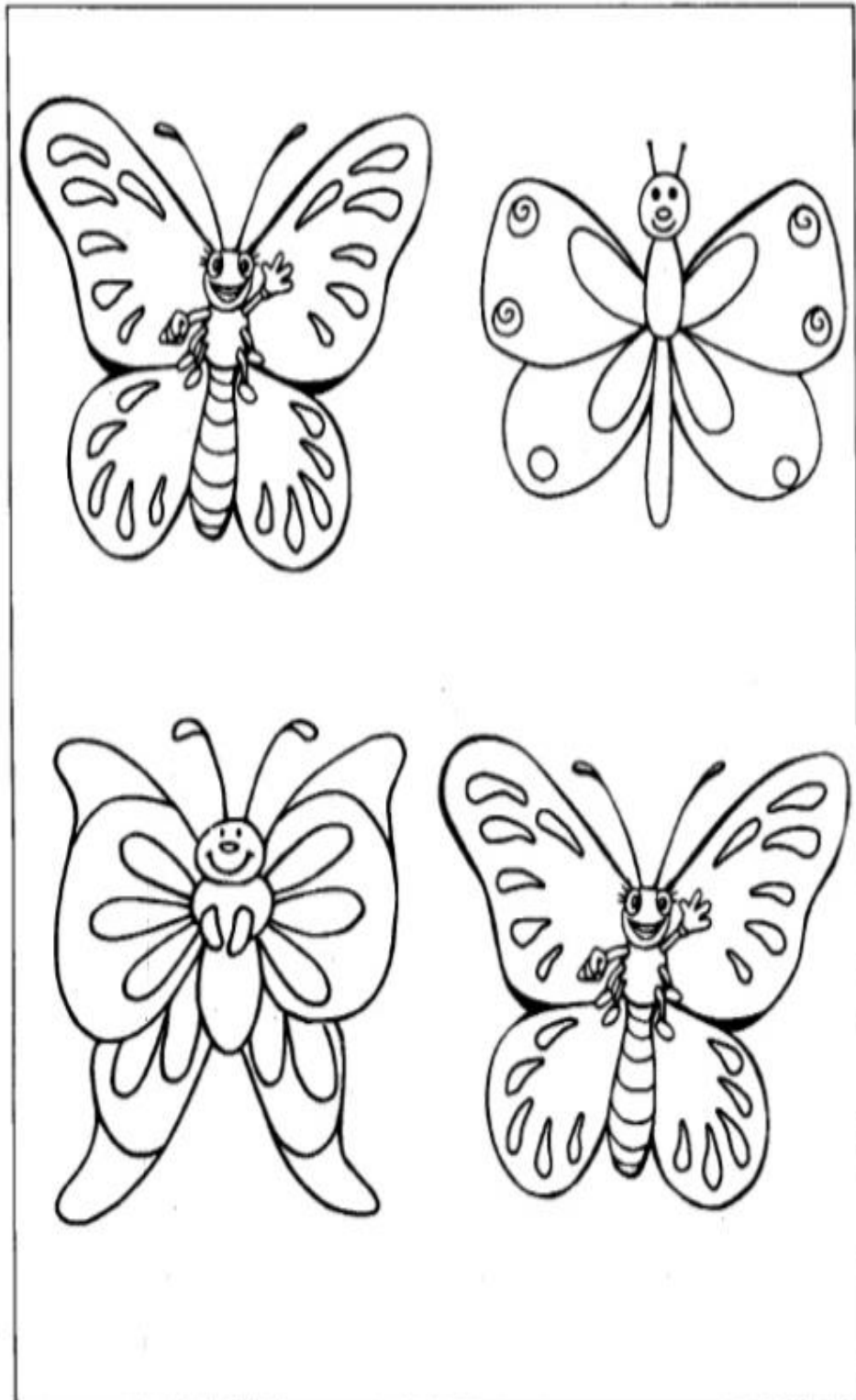

Diferentes

😊 En cada fila colorea la figura que es diferente al modelo.

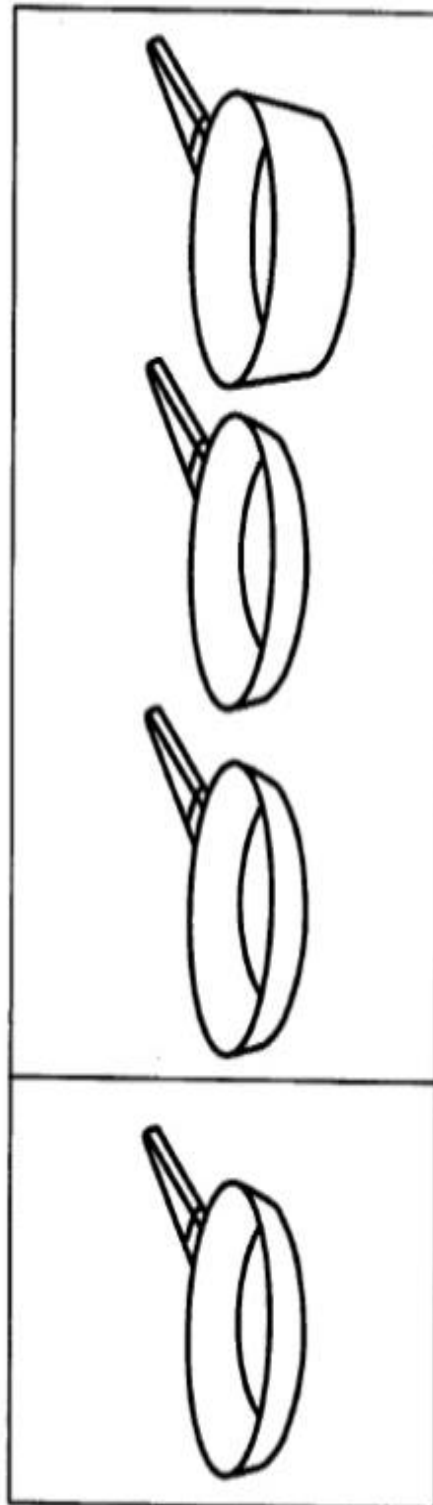
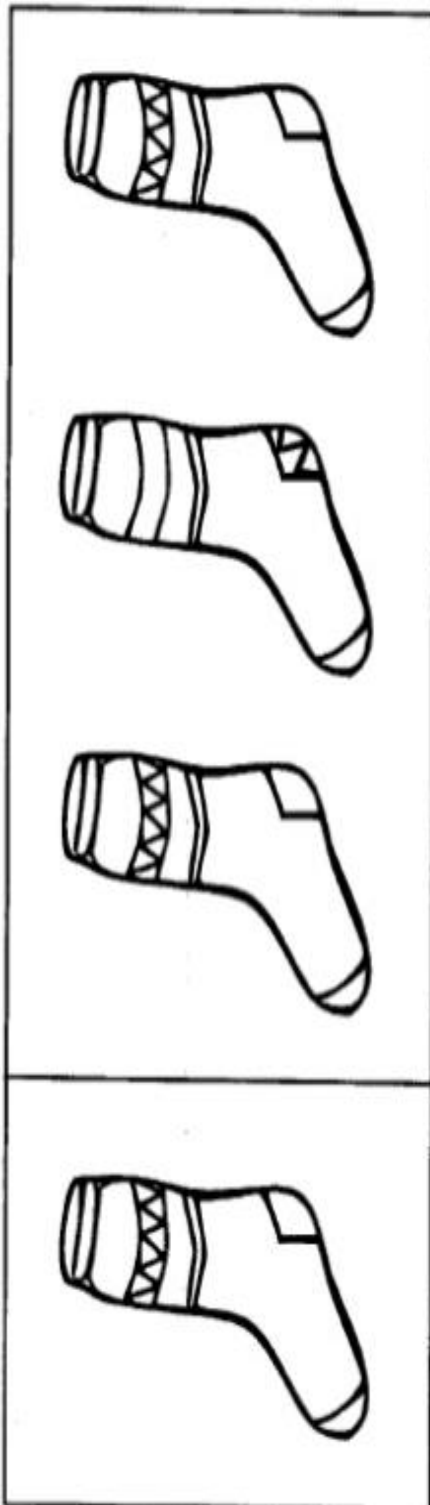



Nombre: Fecha: Curso:



TRAZOS Nº 4

TRAZA LAS LINEAS DE LAS TORRES

TRAZA LOS
MOVIMIENTOS
DEL TIEMPO

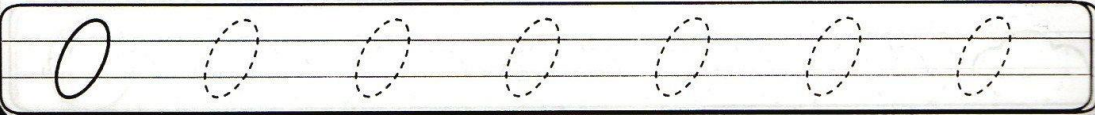
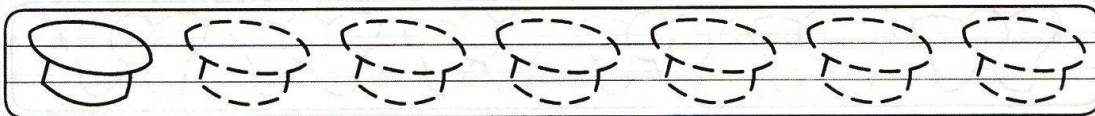
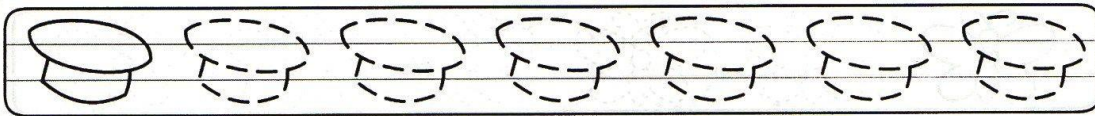
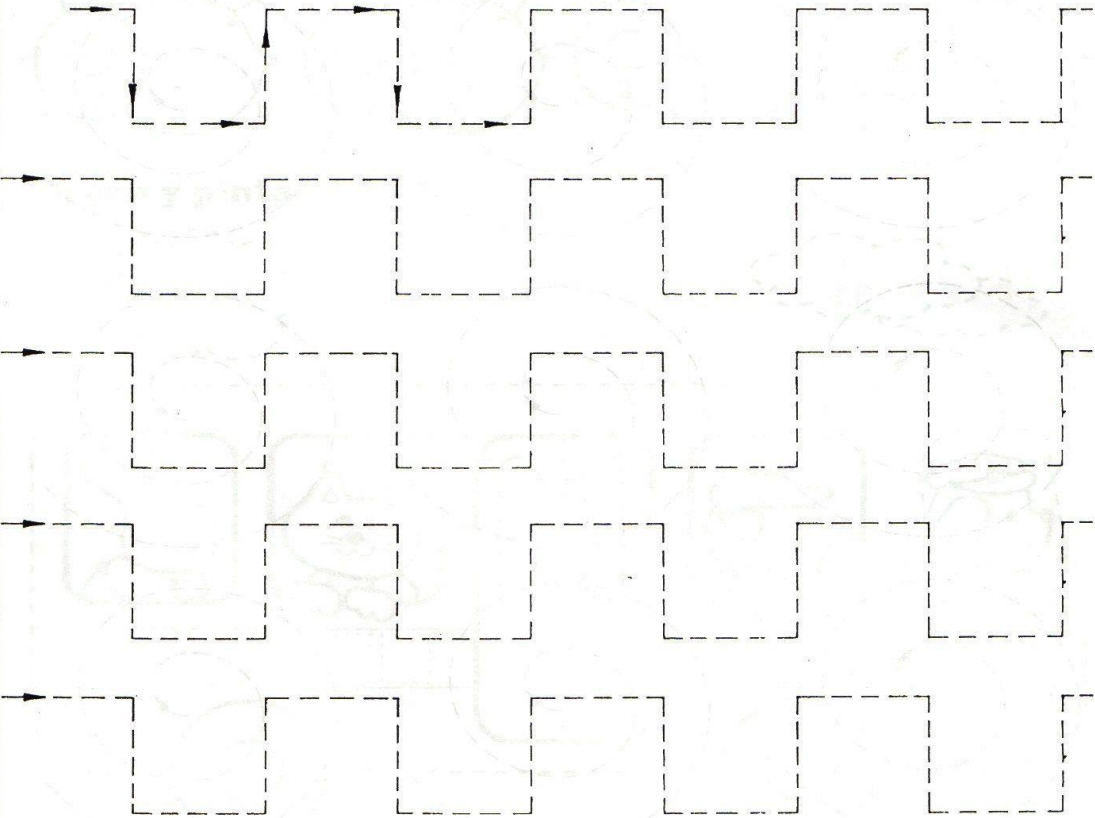

Nombre _____ Fecha _____

Une y luego colorea.

1

3

2

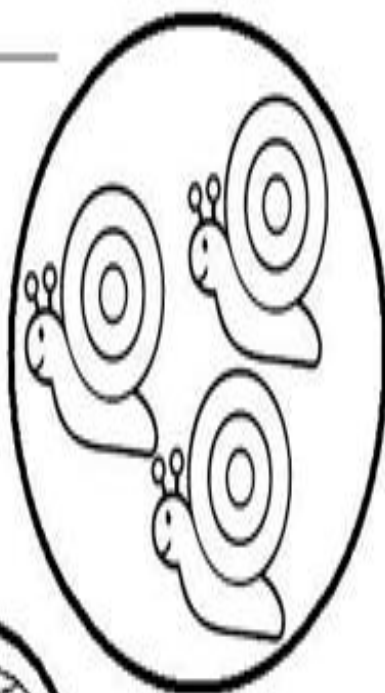

Más elementos

😊 Pinta los elementos del conjunto que tienen más elementos que el modelo.

modelo

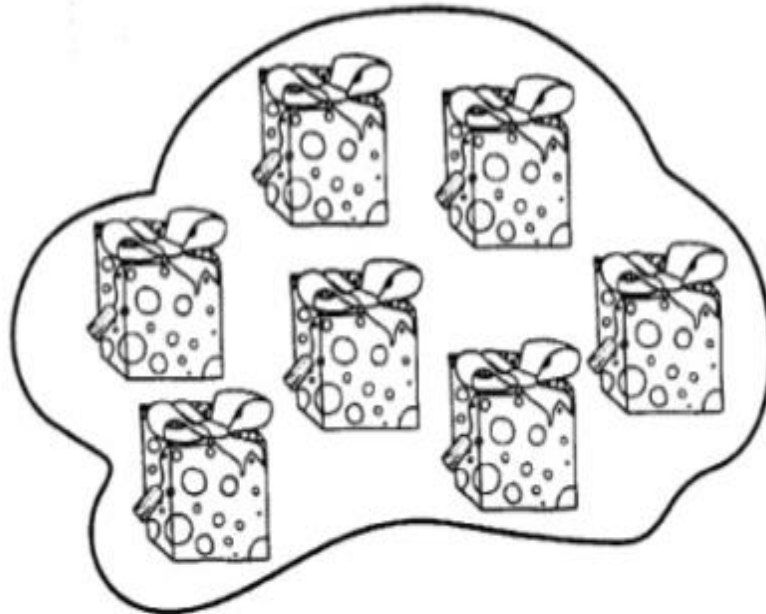
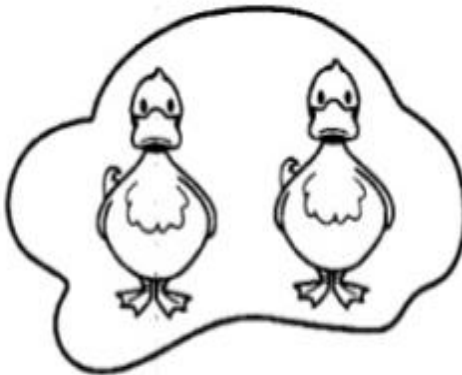
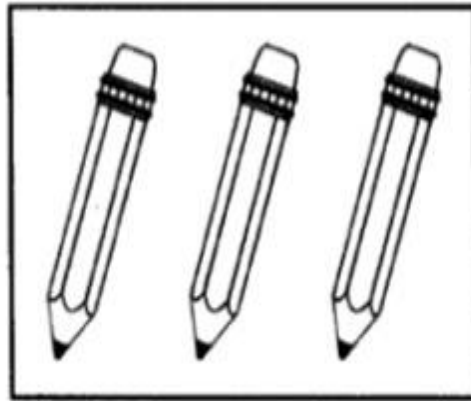

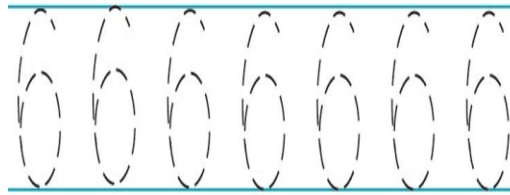
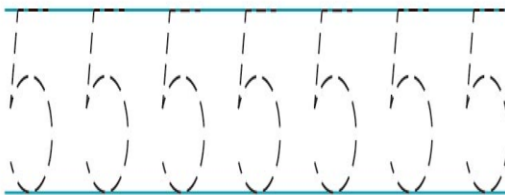
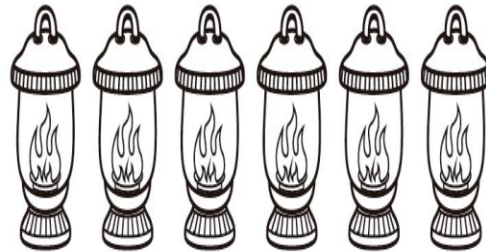
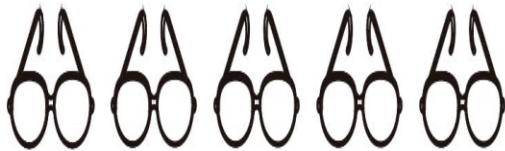
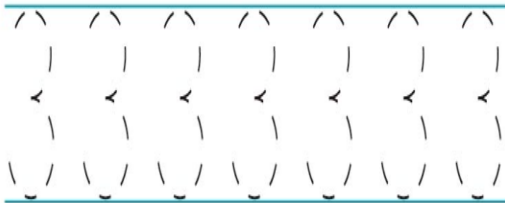
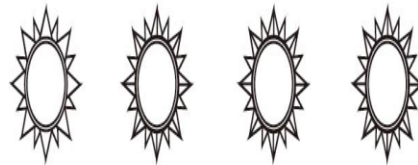
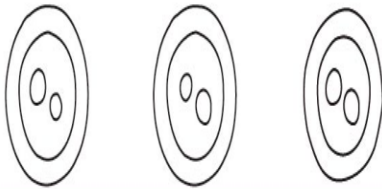
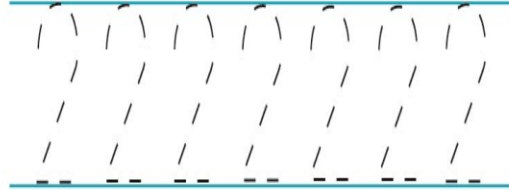
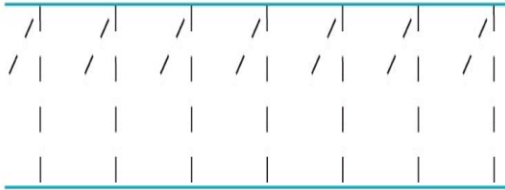
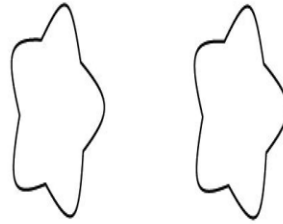



Amarillo



Azul

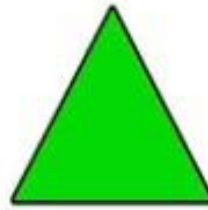

Verde



Rojo

Pinta del mismo color las figuras que sean iguales

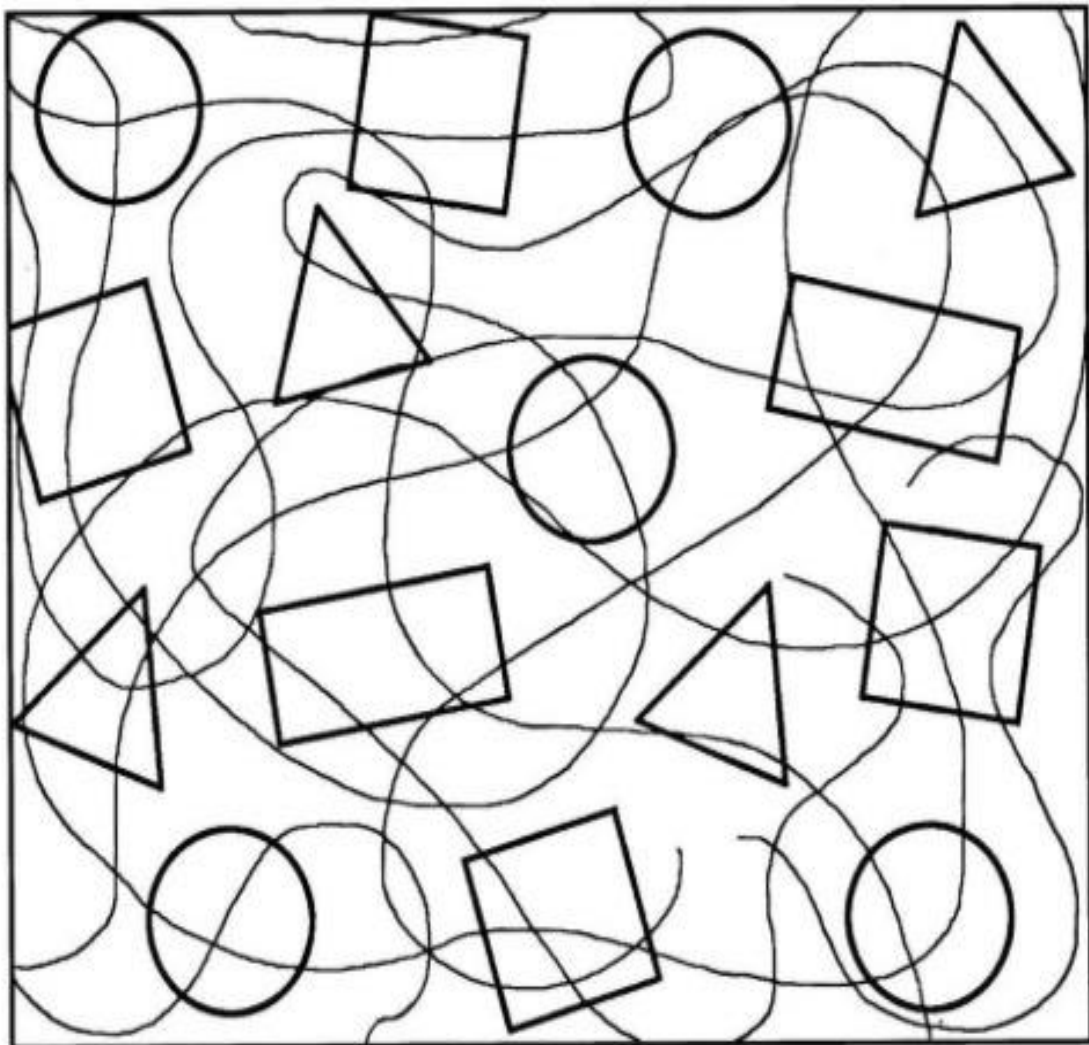

Repasa el número 4

aprendemasMayra.com



¿Cuántos hay? Une los dibujos con su número.

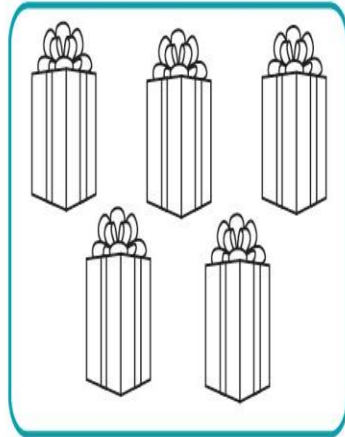
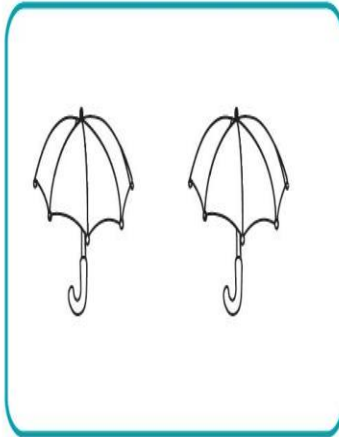
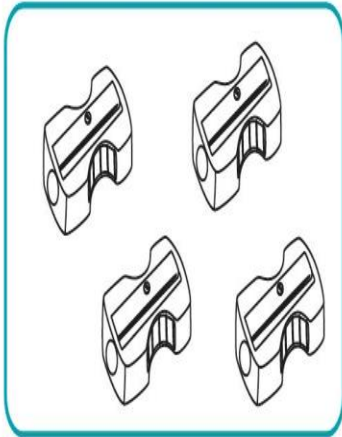

1

2

3

4

5

6

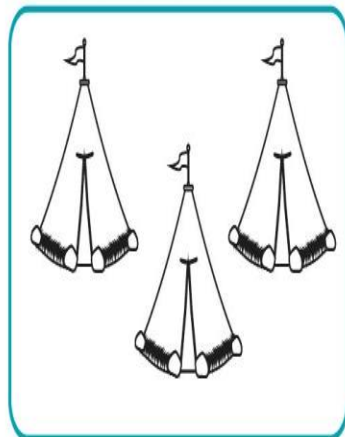
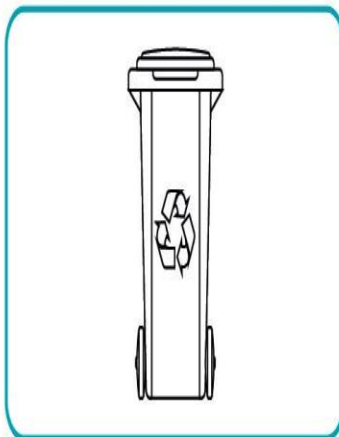
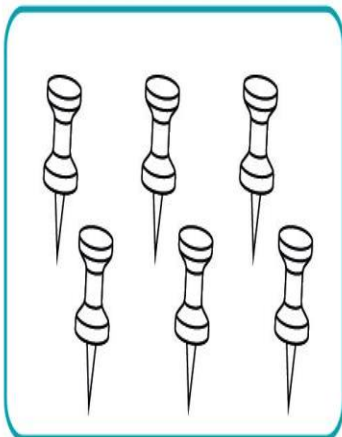

Evaluación inicial 4 años

Nombre: _____ Fecha: _____

Ficha 2: Repaso los números y relaciona la grafía con los gatitos.

1	1	1	1	1	1
2	2	2	2	2	2
3	3	3	3	3	3

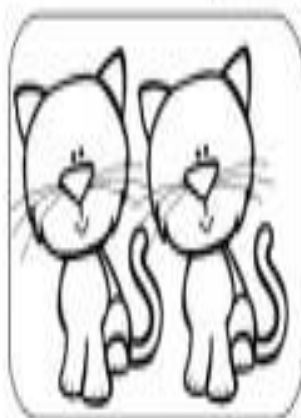

1 2 3

<https://www.imageneseducativas.com/>

Imágenes
Educativas.com

Nombre: _____ Fecha: _____

Ficha 24 • Repasar los números • Unir cada número con la cantidad que representa.





● Evaluación inicial 4 años

Nombre: _____ Fecha: _____

Ficha 1: Rodea los objetos que tiene forma de triángulo.

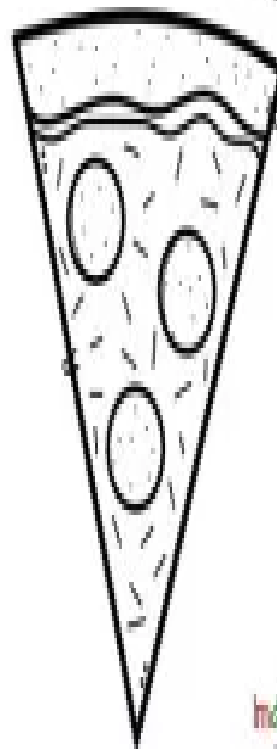
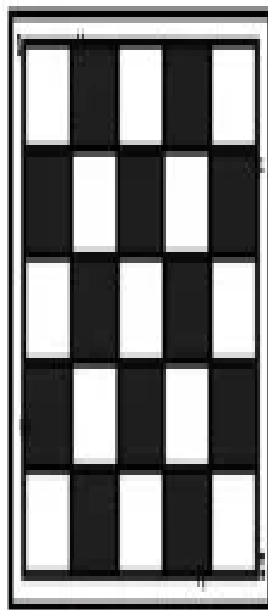
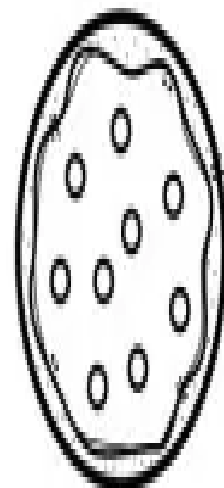
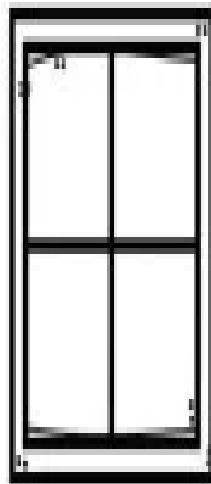
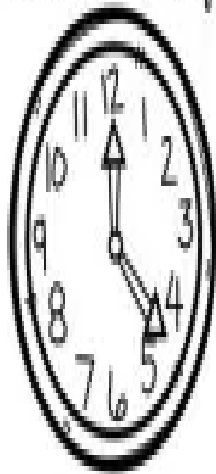



Nombre: _____ Curso: _____ Fecha: _____

Cuántos hay



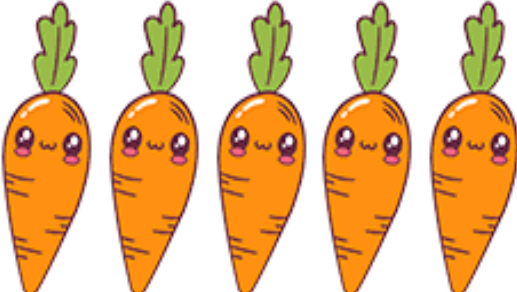

Rodea el número correcto:

		
6	4	5

		
2	1	3

		
9	8	7

		
5	4	6

		
7	5	9

		
5	6	7

Conjuntos

- * Ubica los conjuntos con la misma cantidad de elementos y pntalos del mismo color.

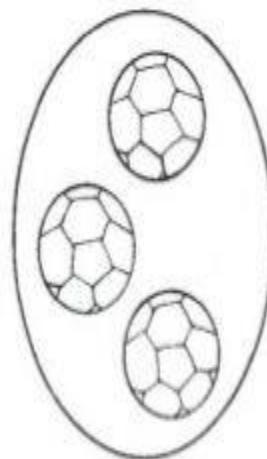
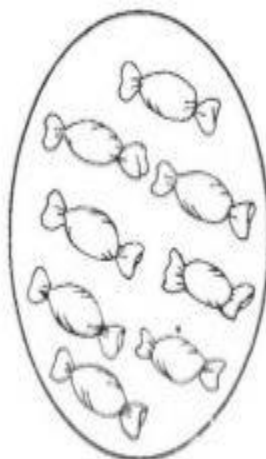
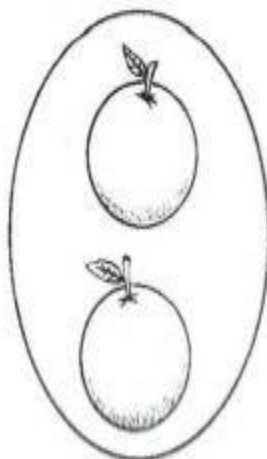
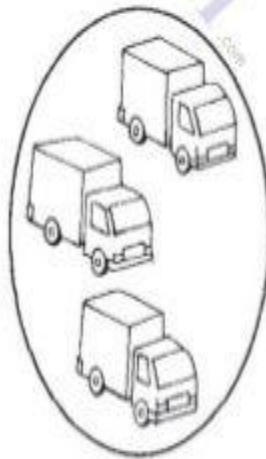
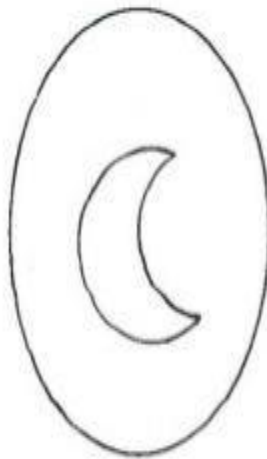
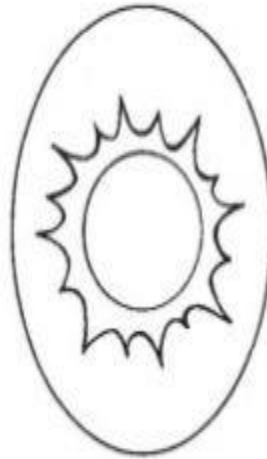
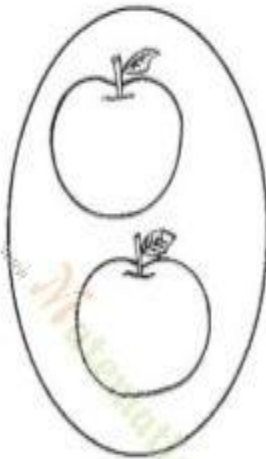
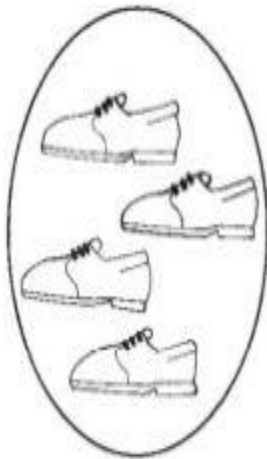

¡A contar...!

* Escribe el número que corresponda:

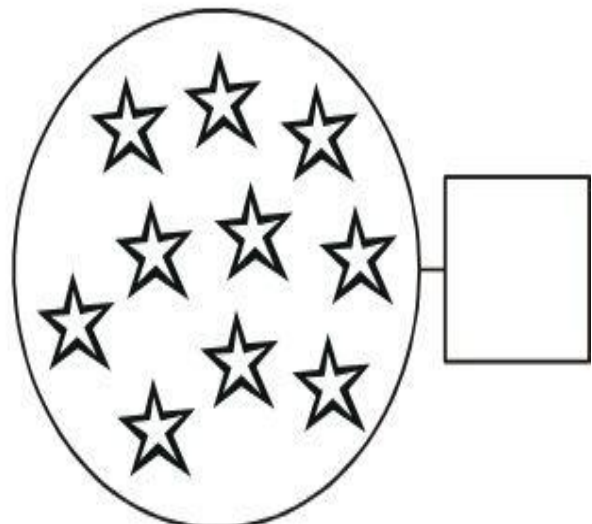
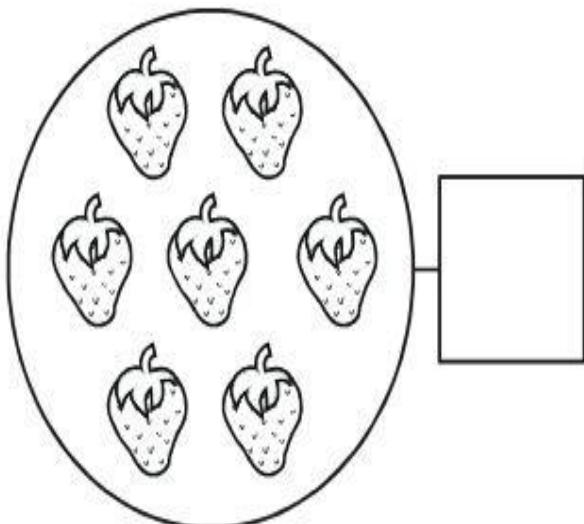
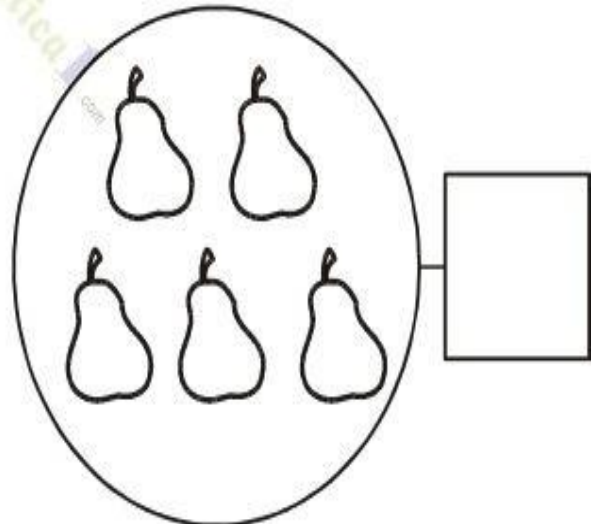
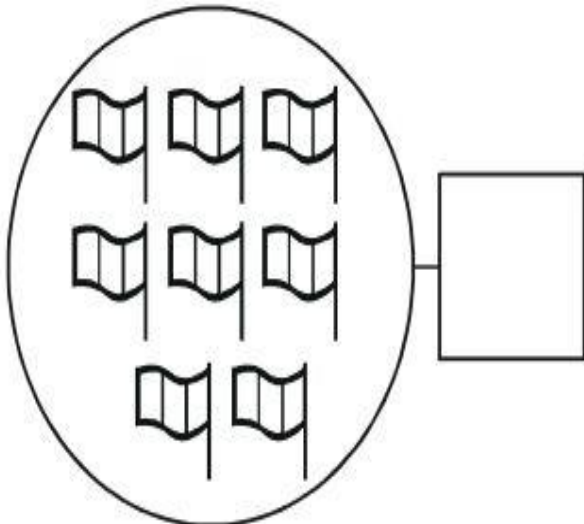
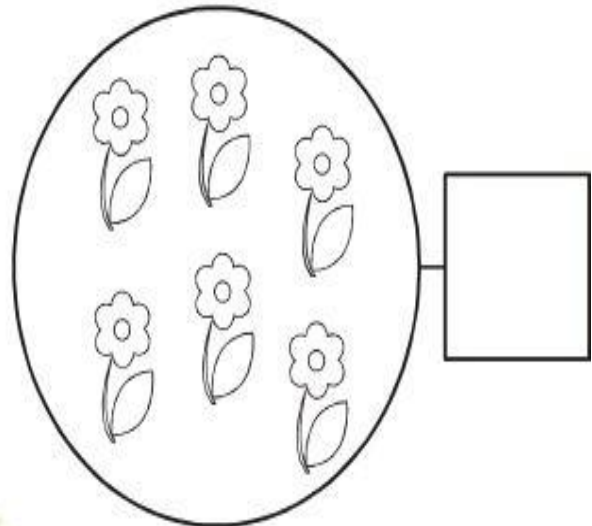
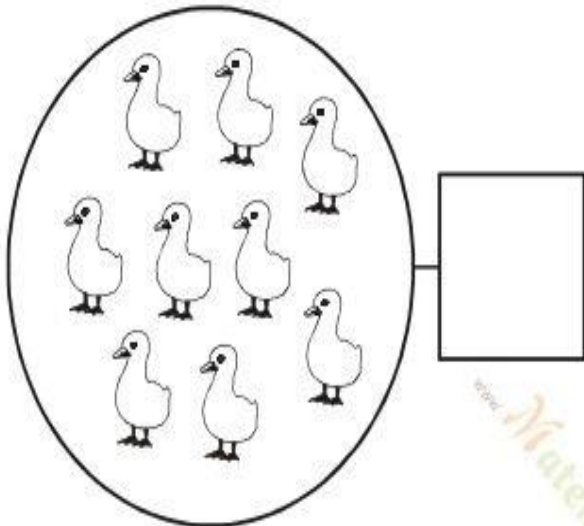

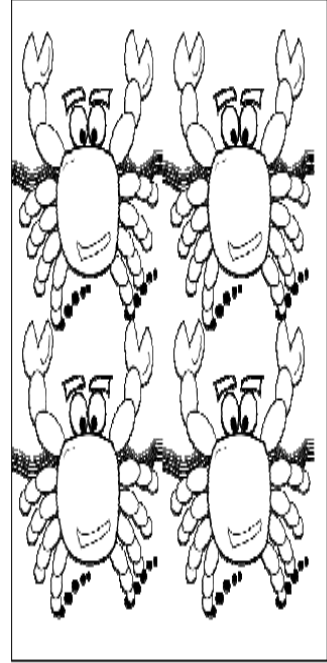
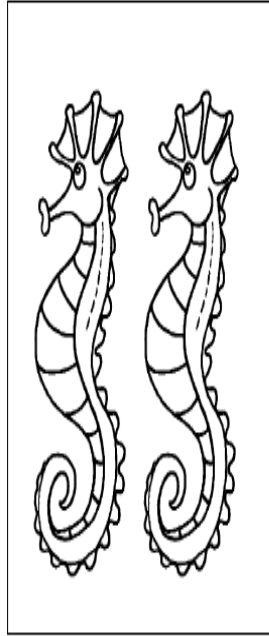
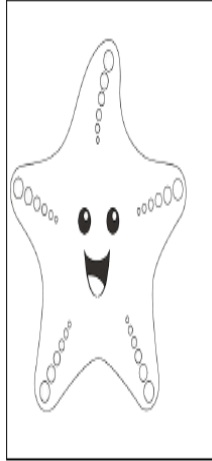

4

3

4

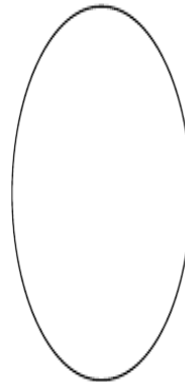
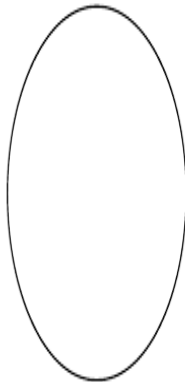
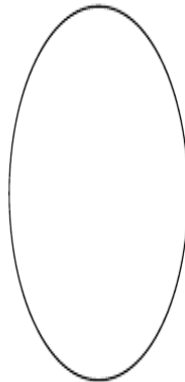
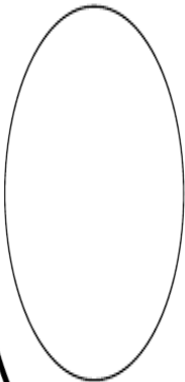

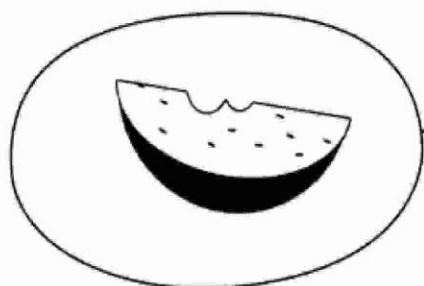

1

1 1 1 1

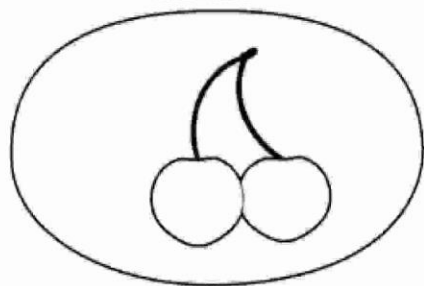

2

2 2 2 2

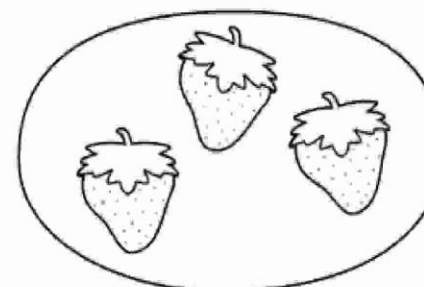

3

3 3 3 3

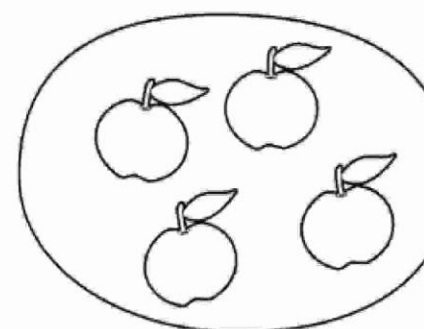

4

4 4 4 4

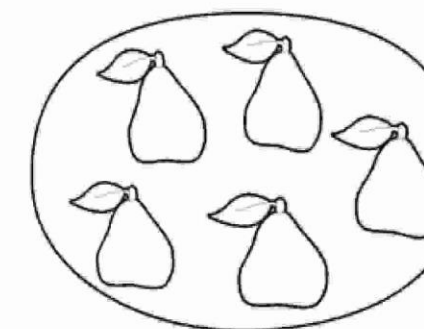

5

5 5 5 5

COLEGIO SAN JOSE DE CUCUTA SEDE MERCEDES ABREGO

CURSO TRANSICIÓN

NOMBRE: _____ FECHA: _____

CUENTA LOS ELEMENTOS Y ESCRIBE EL NÚMERO AL LADO.

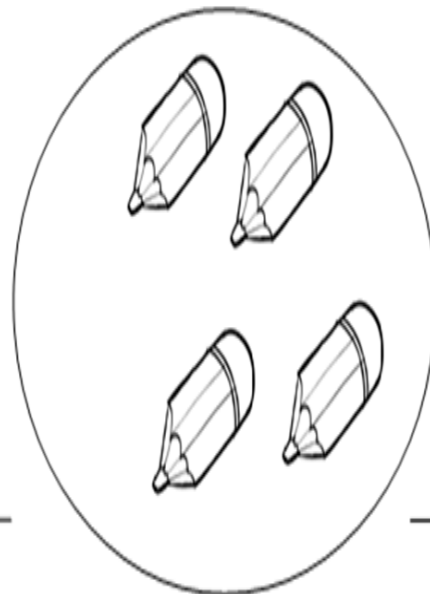
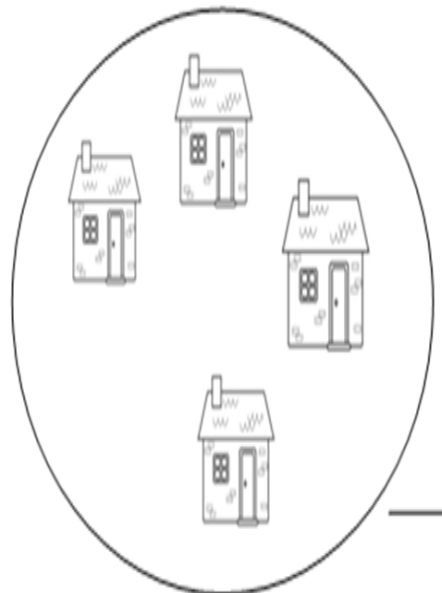
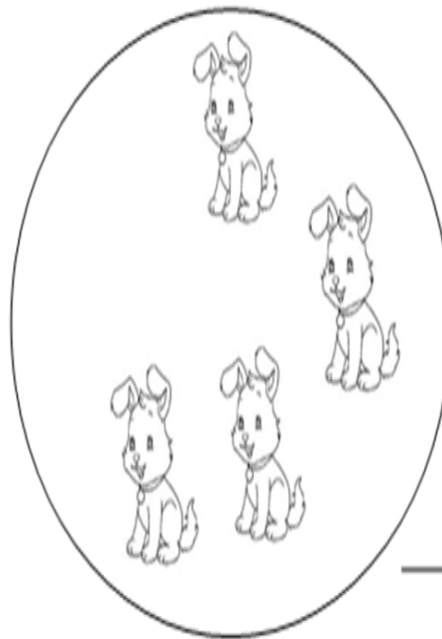
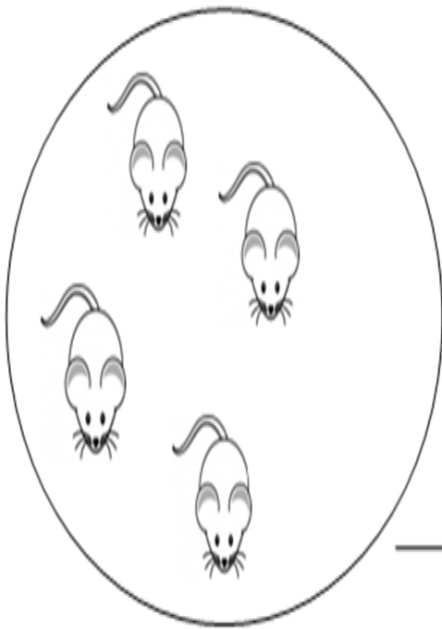

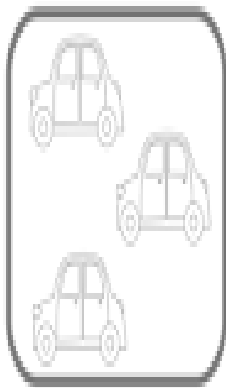

1

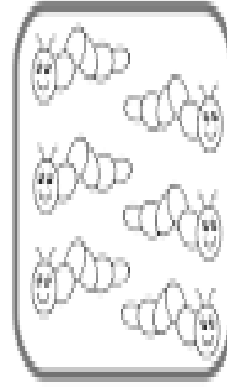

2

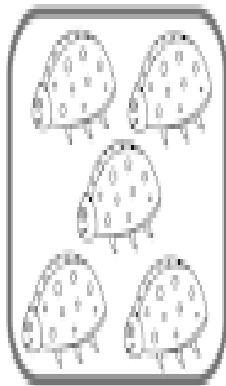

3

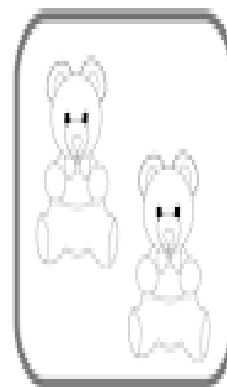

4

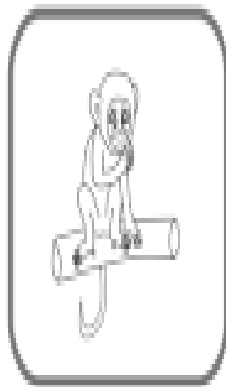

5

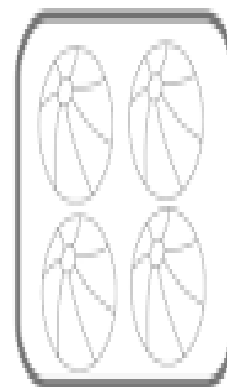

6

Cuenta los objetos que hay en cada uno de los cuadros y únelos con su número.

NOMBRE

El número 1

FECHA

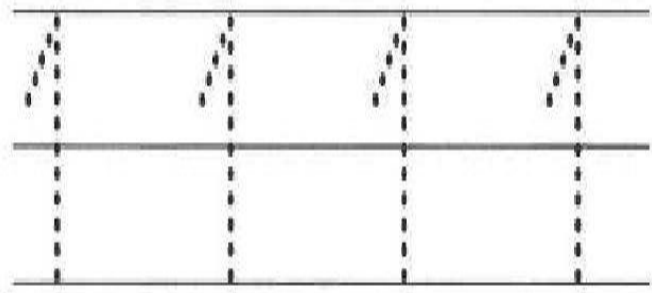
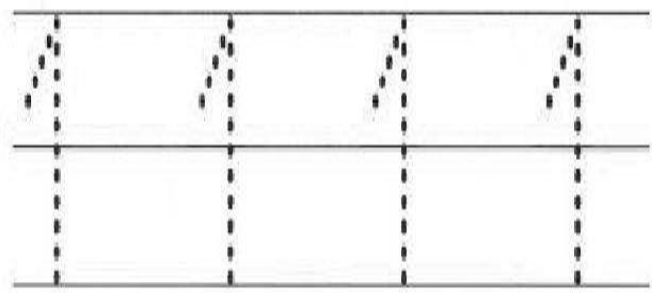
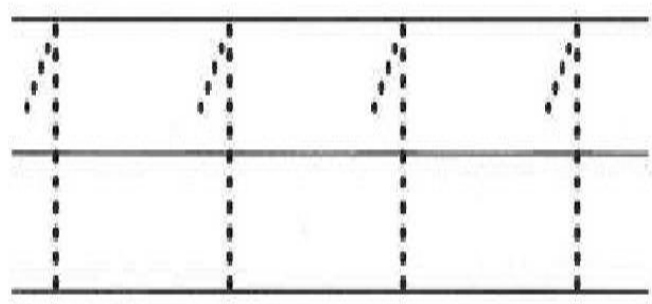
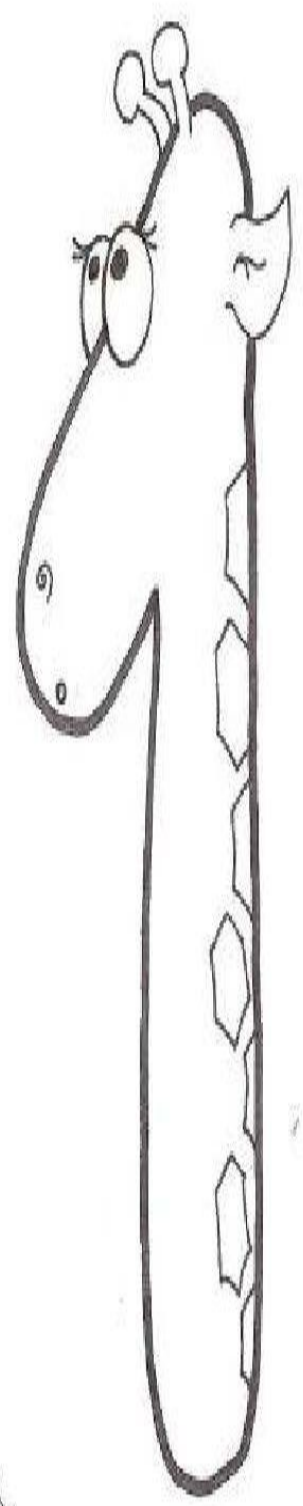

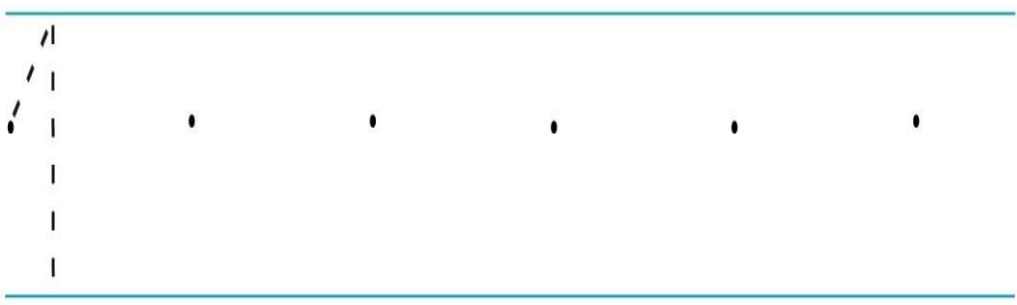
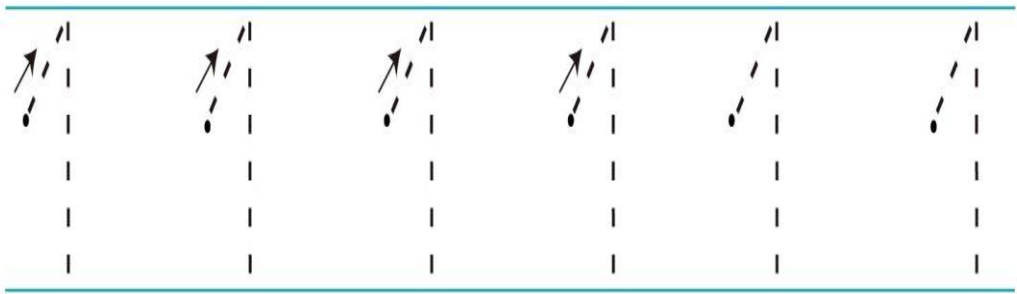
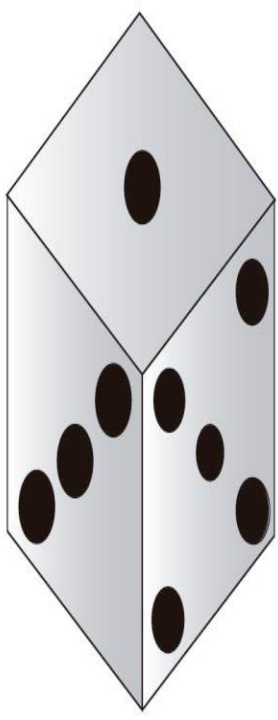



REALITZA LES GRAFIES

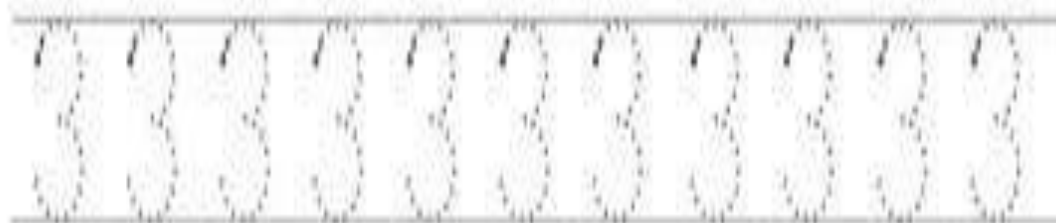
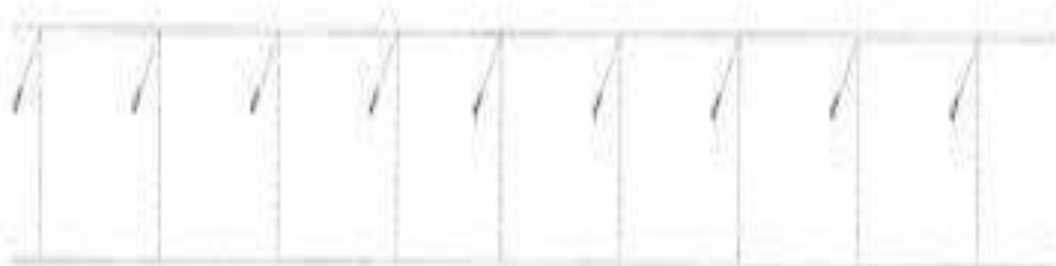

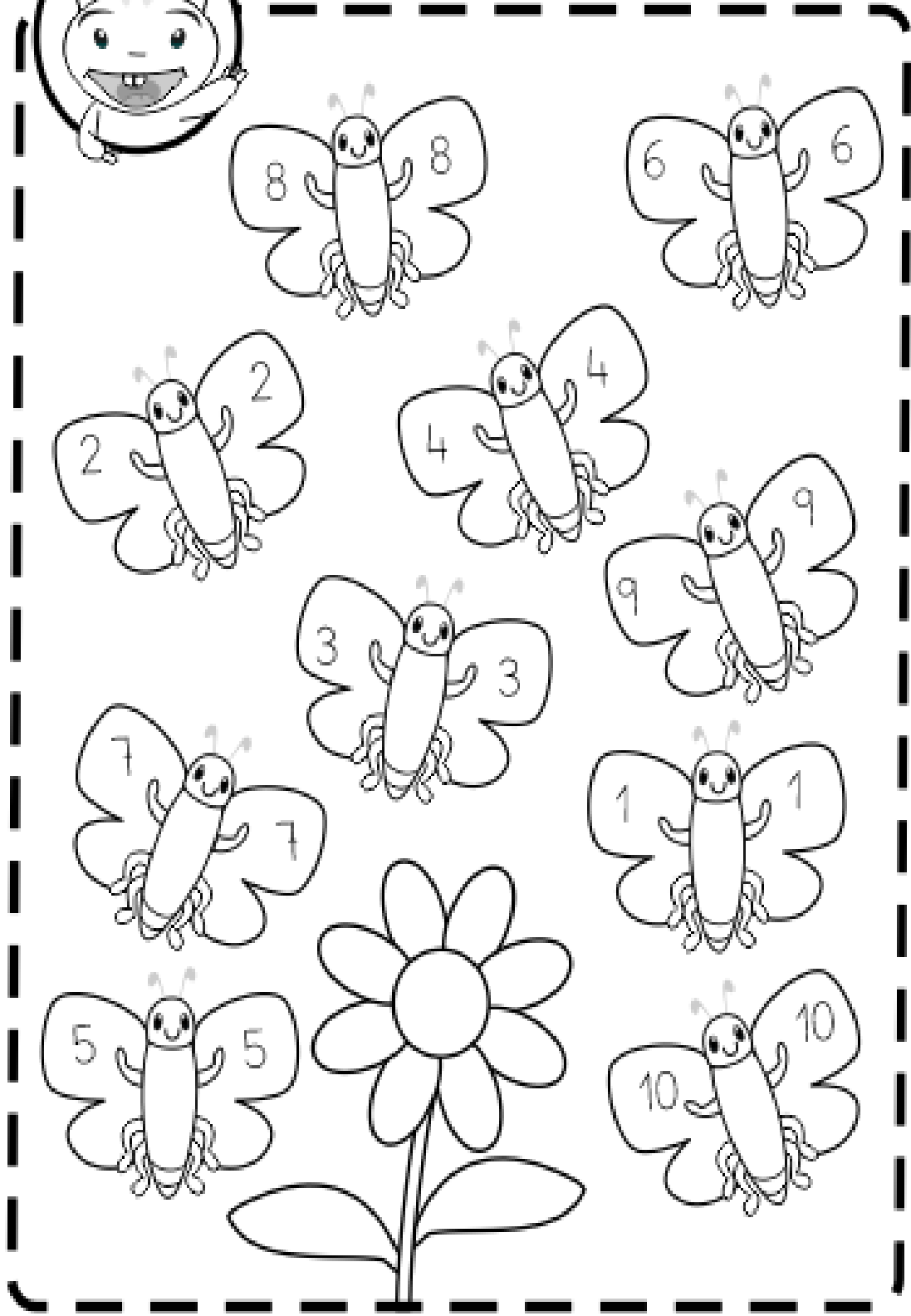
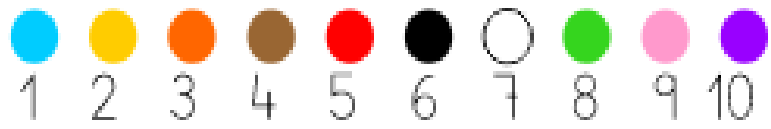

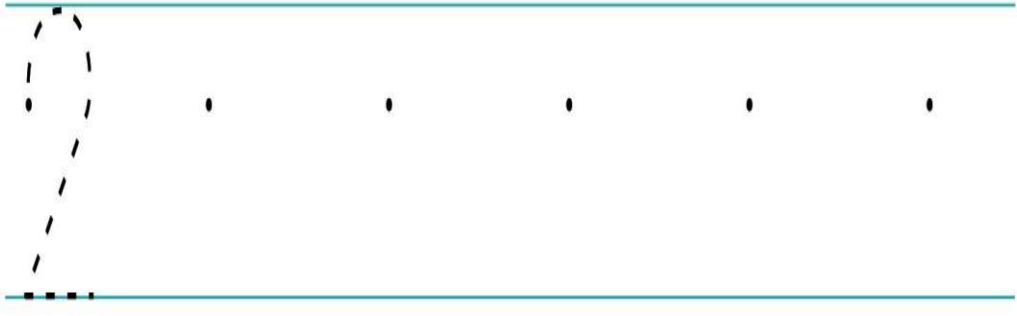
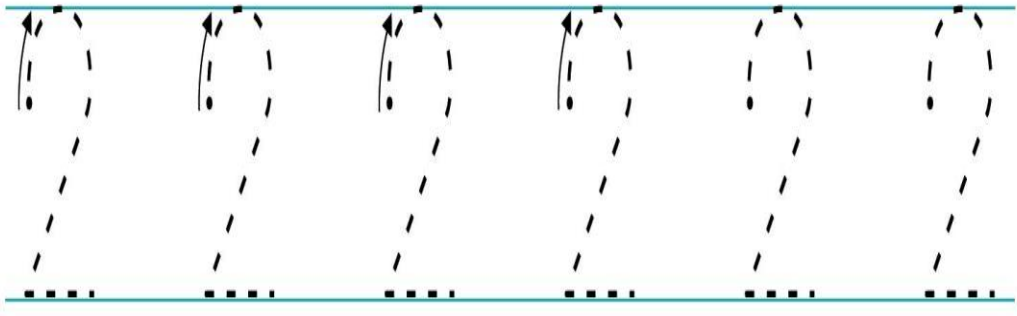
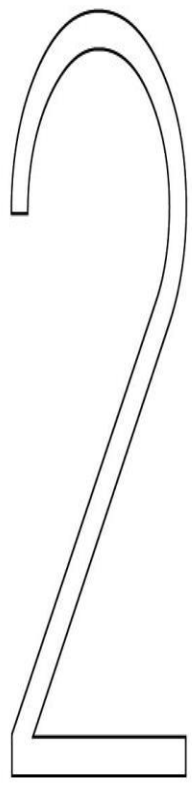
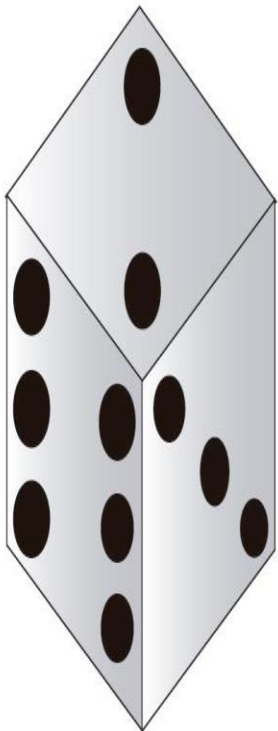

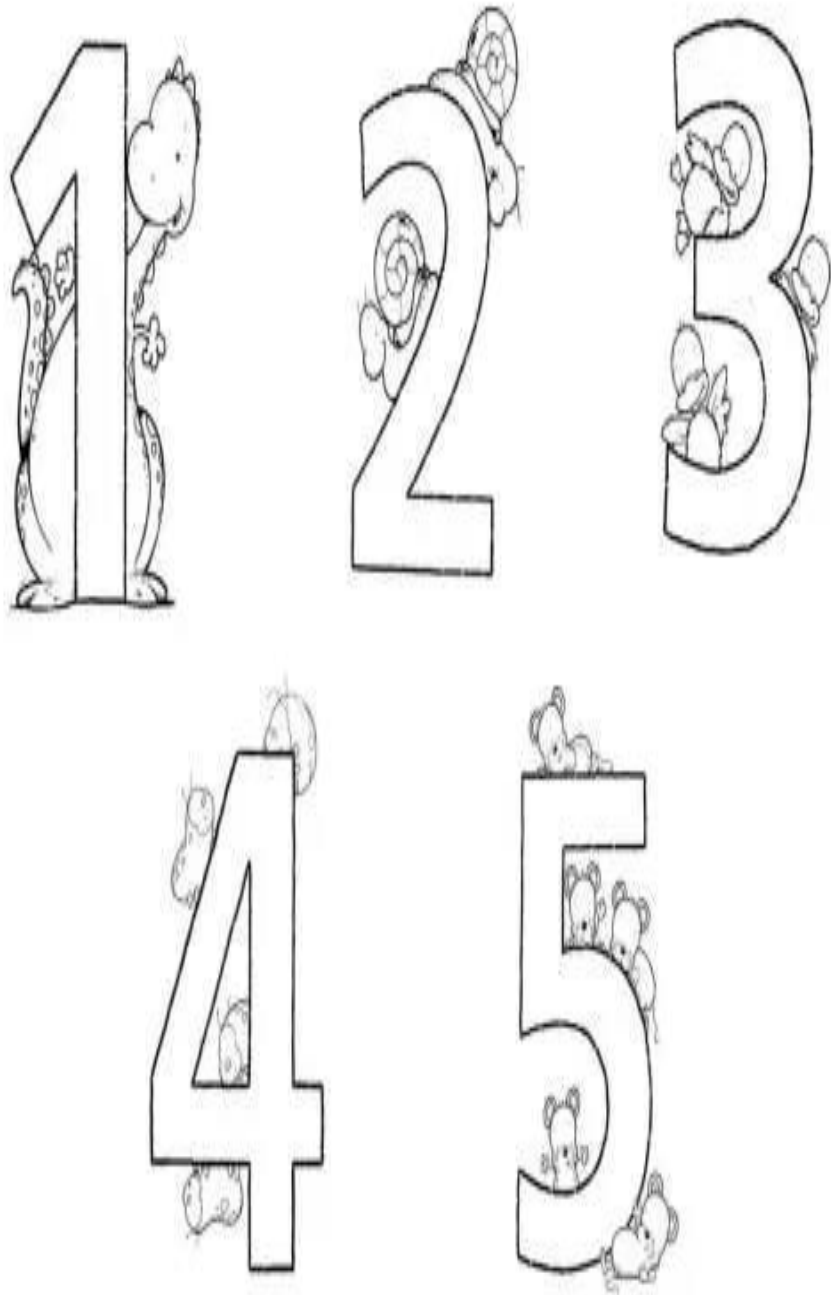

Aprende y colorea

www.escuelaenlanube.com

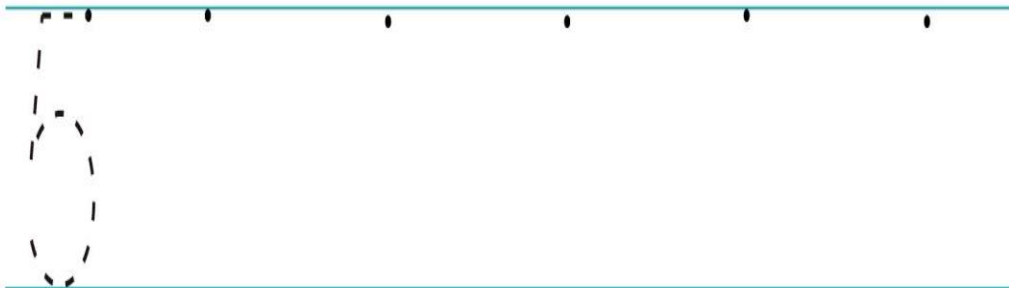
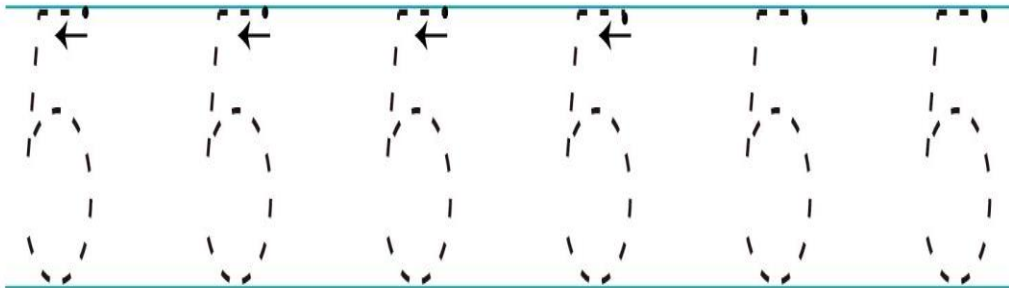
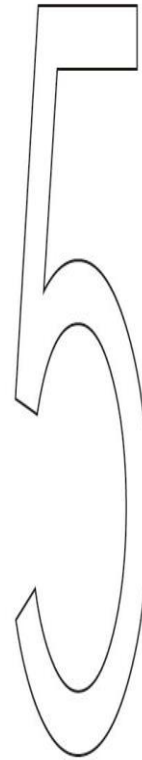
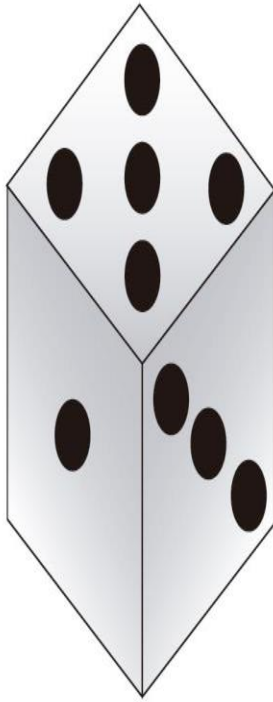





ACTIVIDAD: **COLOREA CON NÚMEROS**

Nombre:

Fecha:



Colorea según los números:

- 1

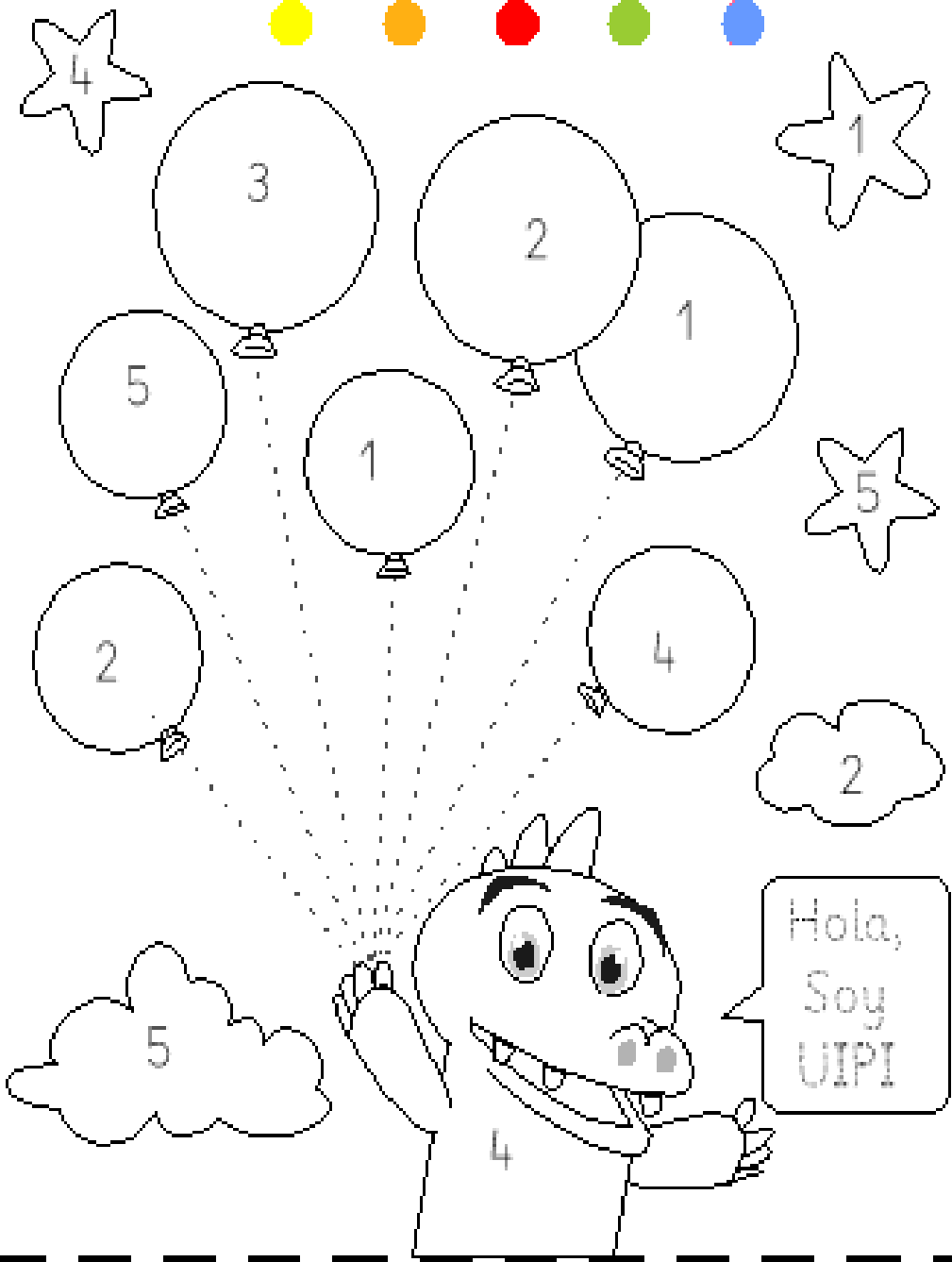
- 2

- 3

- 4

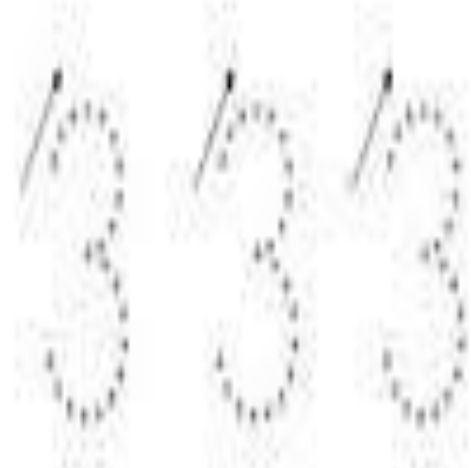
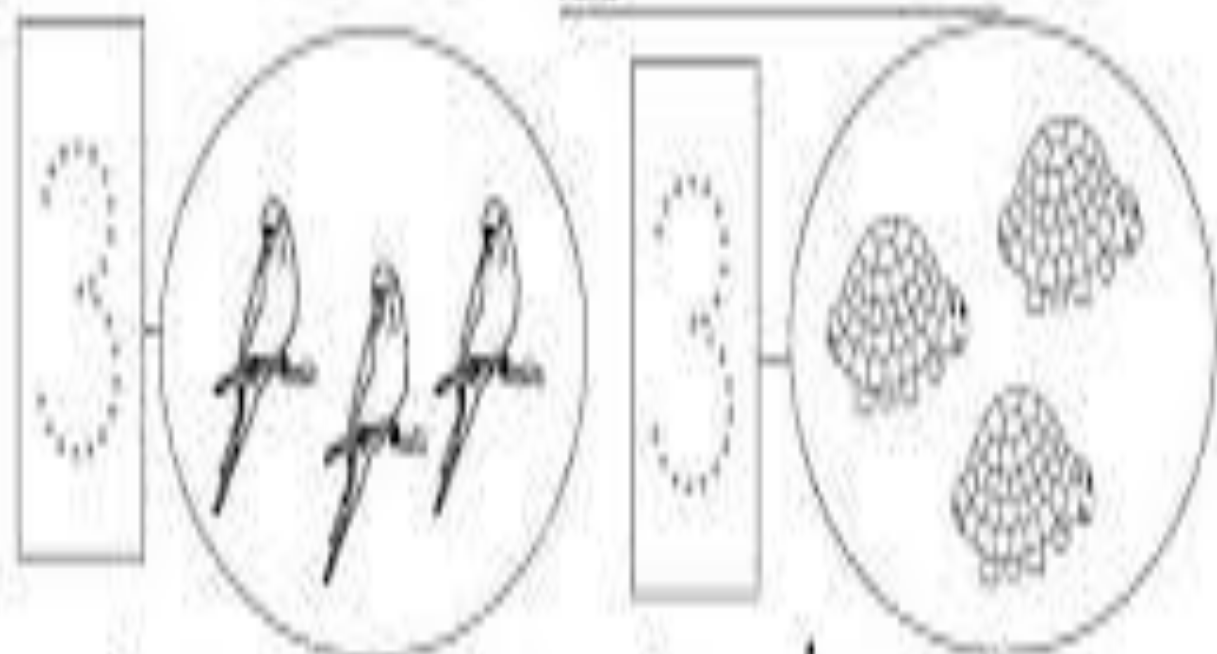
- 5

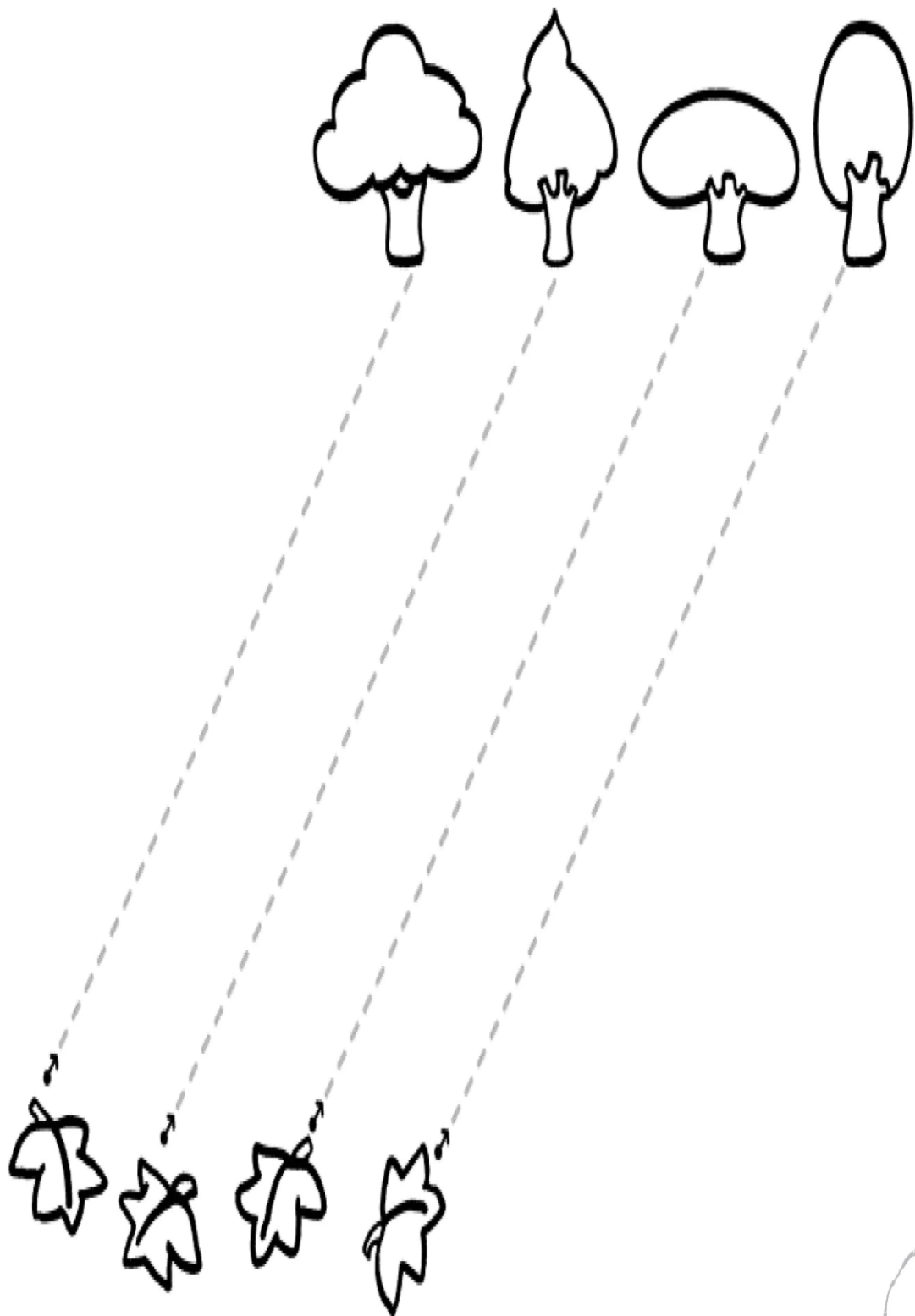

Nombre _____

Fecha _____





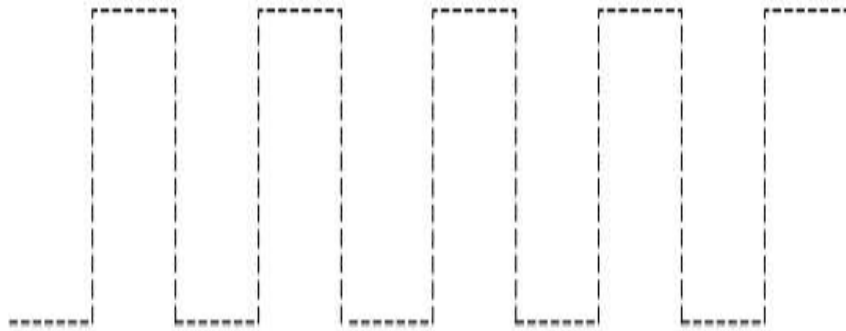
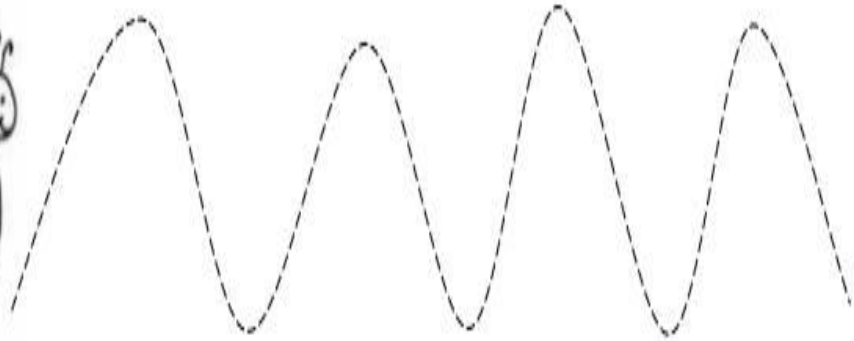

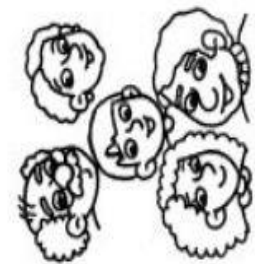
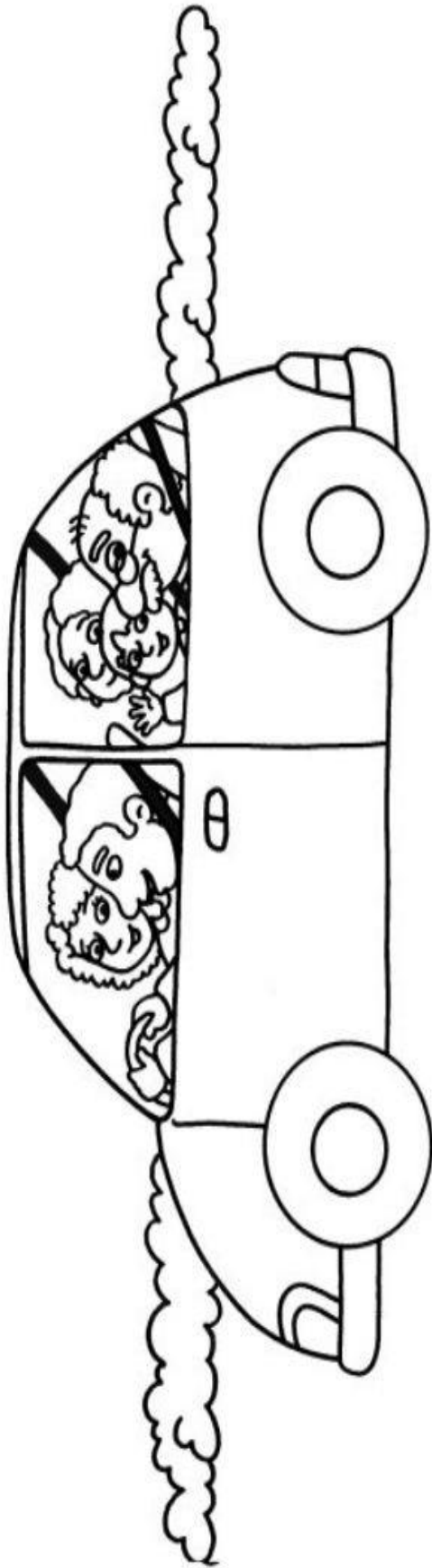

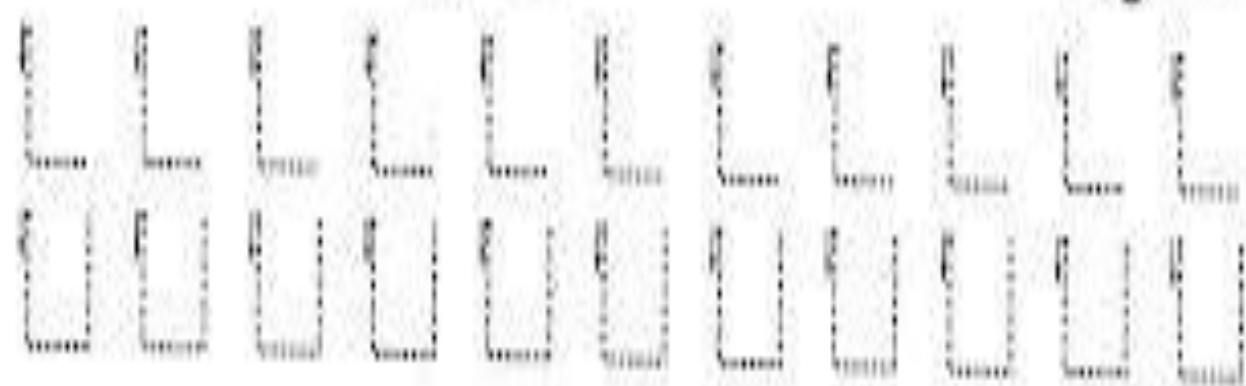
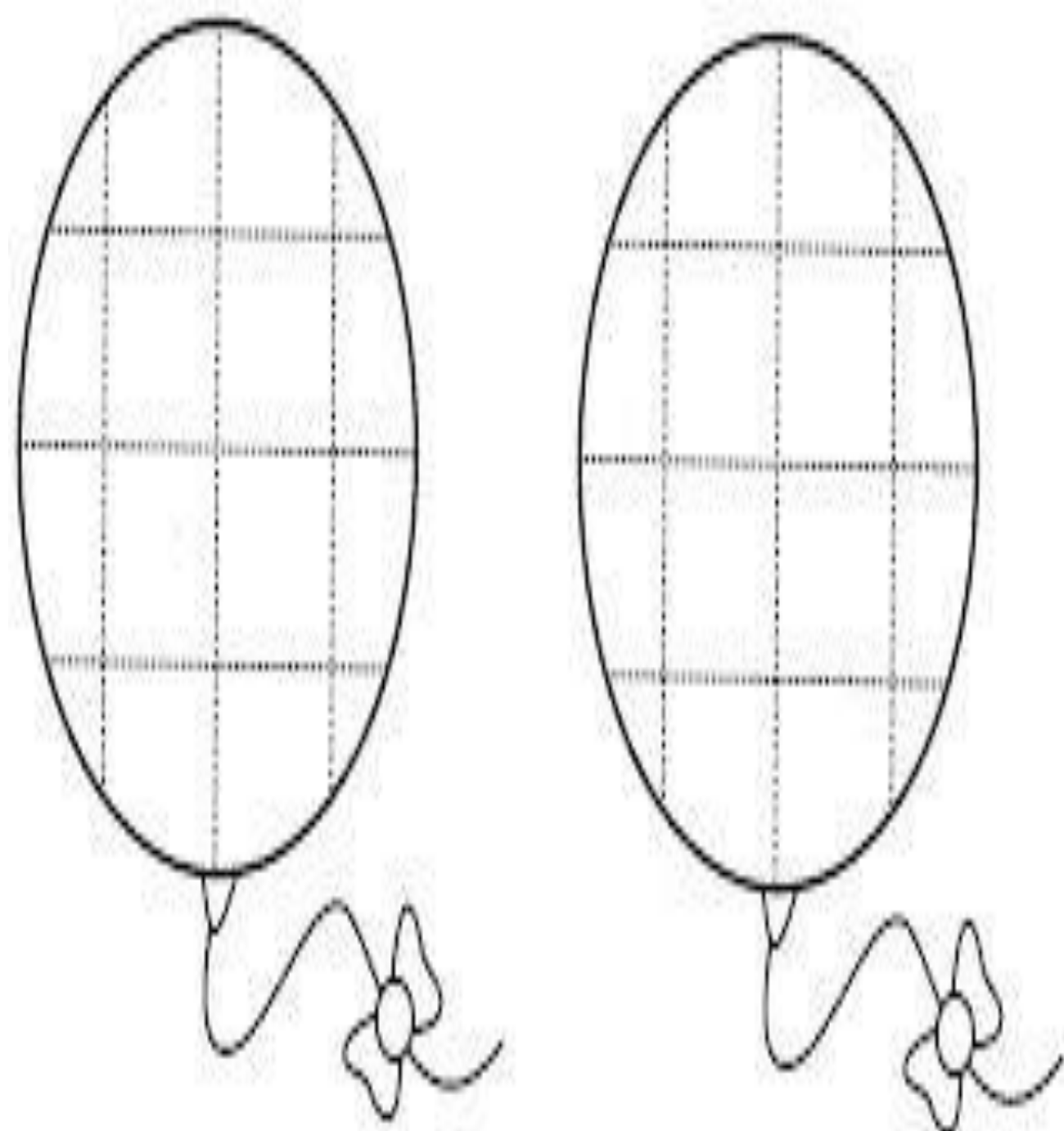

Repetir los trazos verticales y horizontales.

