

# Cuadernillo Preescolar

7

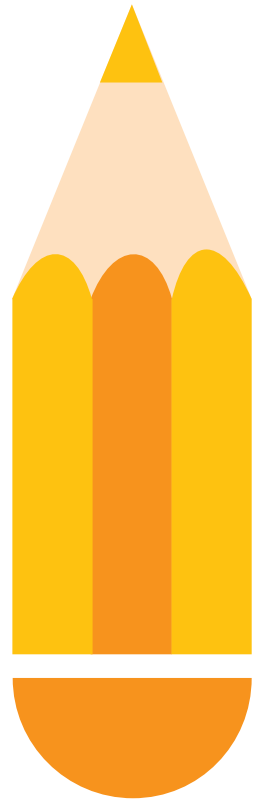
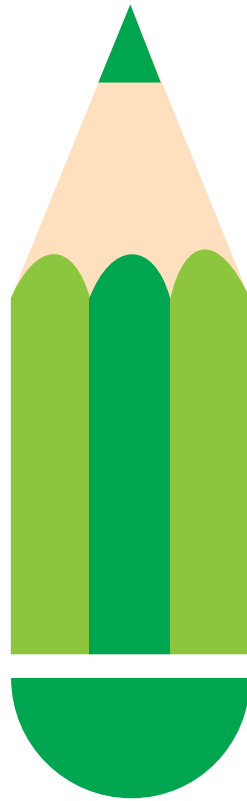
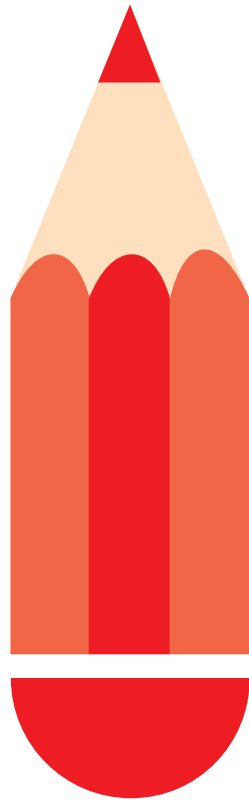
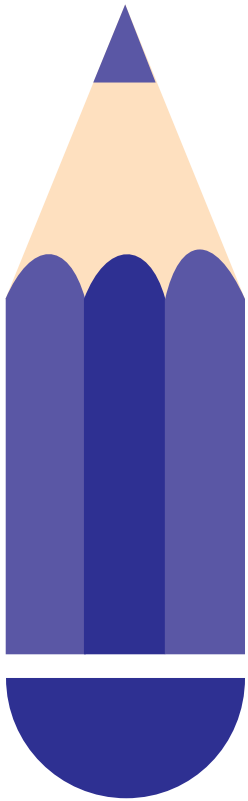

Nombre:

Fecha:

**Actividad 01:** Colorea de marrón lo que está debajo de la mesa y de naranja lo que está encima.

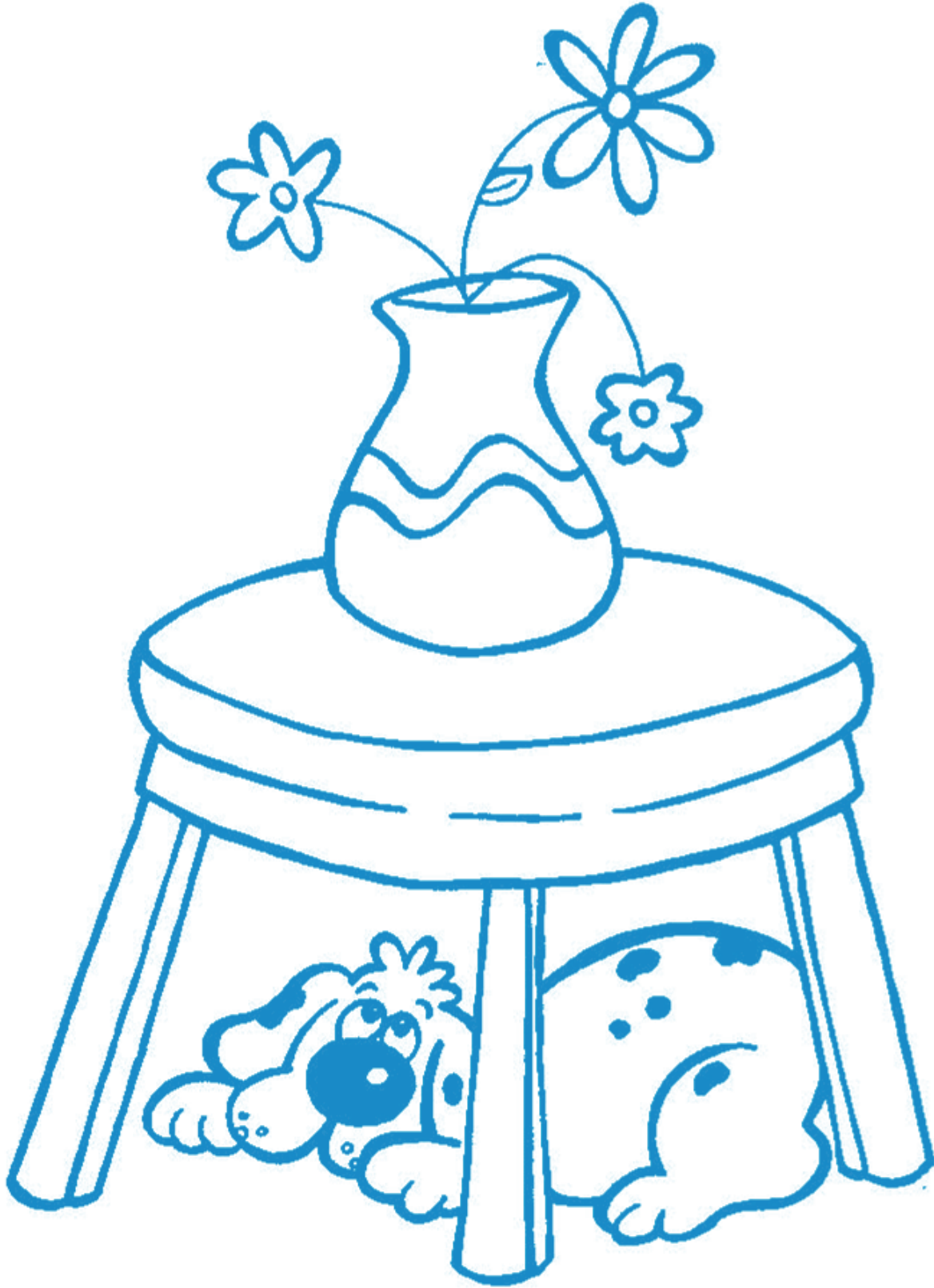

Nombre:

Fecha:

**Actividad 02:** Colorea sólo los que van delante.

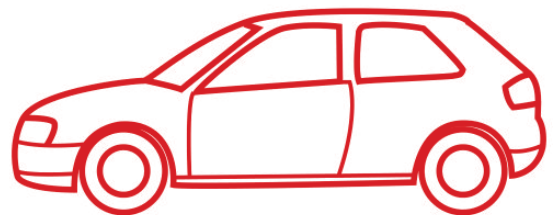
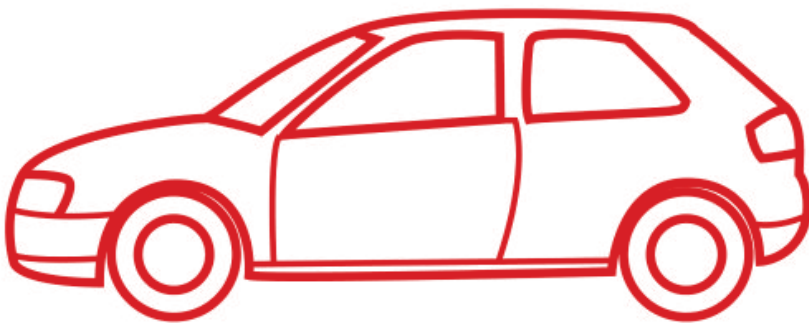
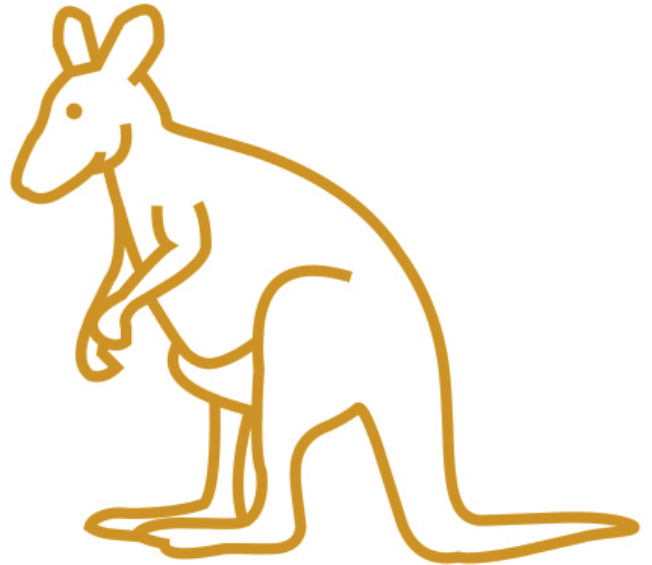
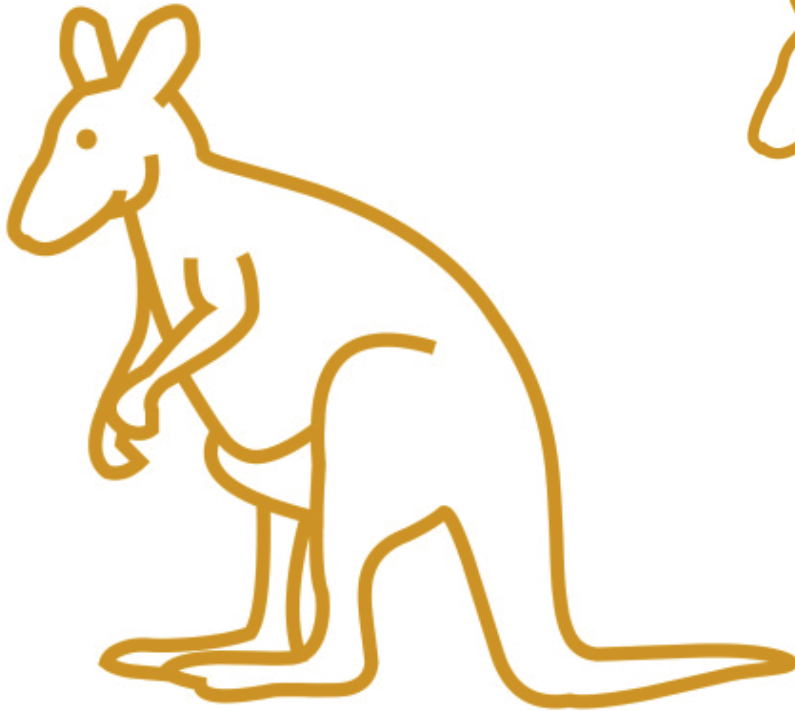

Nombre:

Fecha:



**Actividad 03:** Colorea las nubes que están alrededor del sol.

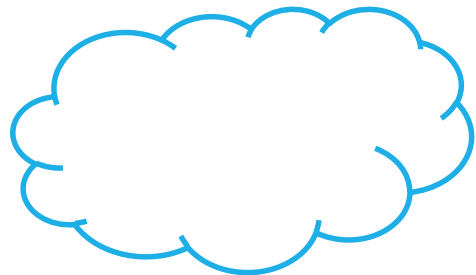
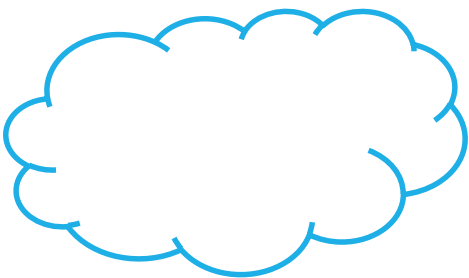
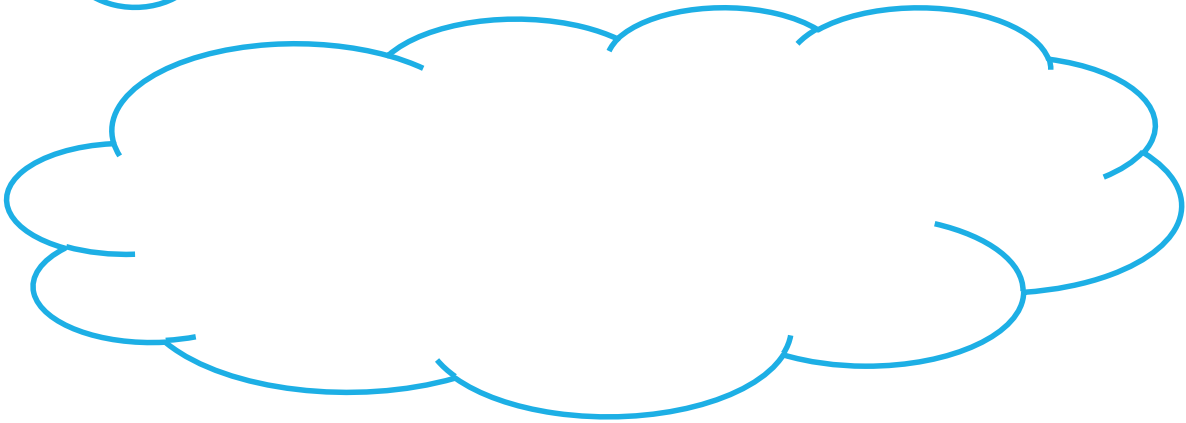
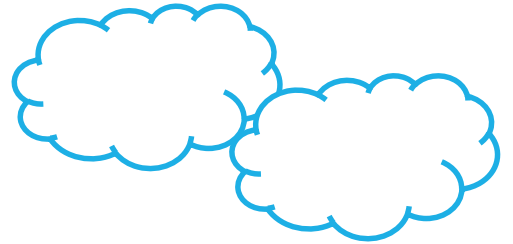
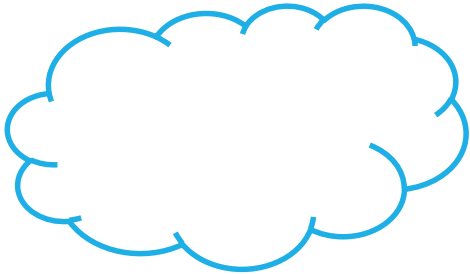
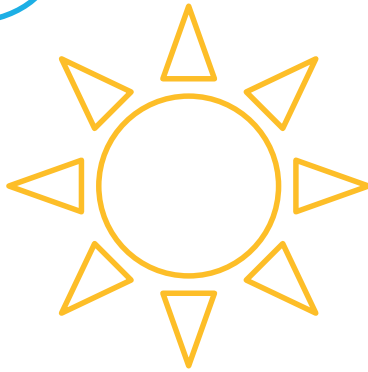
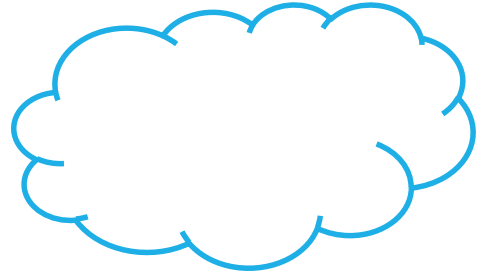
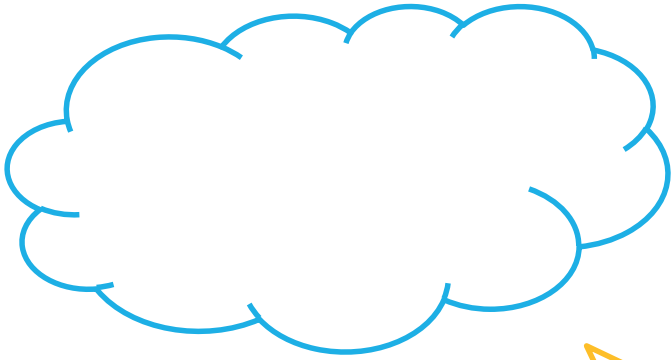

Nombre:

Fecha:

**Actividad 04:** Une con una línea los dibujos que se relacionan entre sí y píntalos.

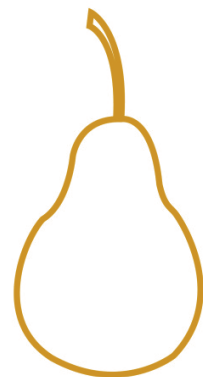
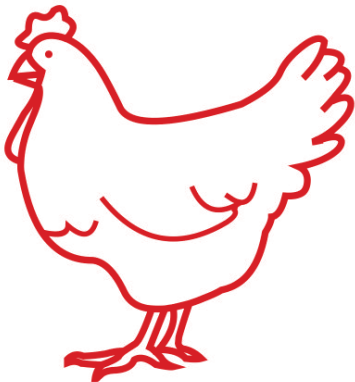
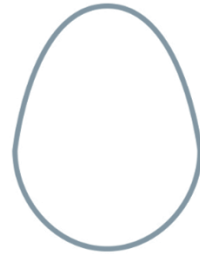
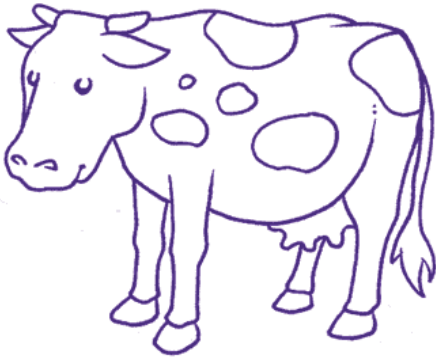

Nombre:

Fecha:



**Actividad 05:** Colorea y escribe el número 6.

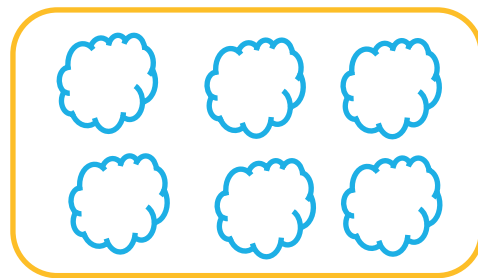
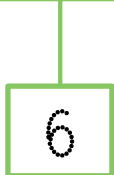
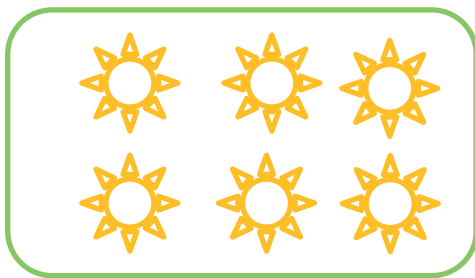
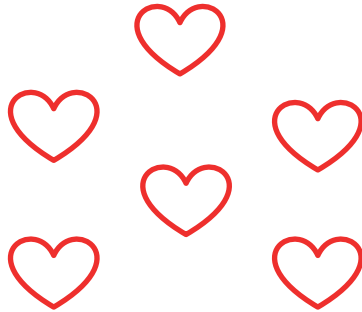

Nombre:

Fecha:



**Actividad 06:** Repasa las líneas y colorea las orugas.

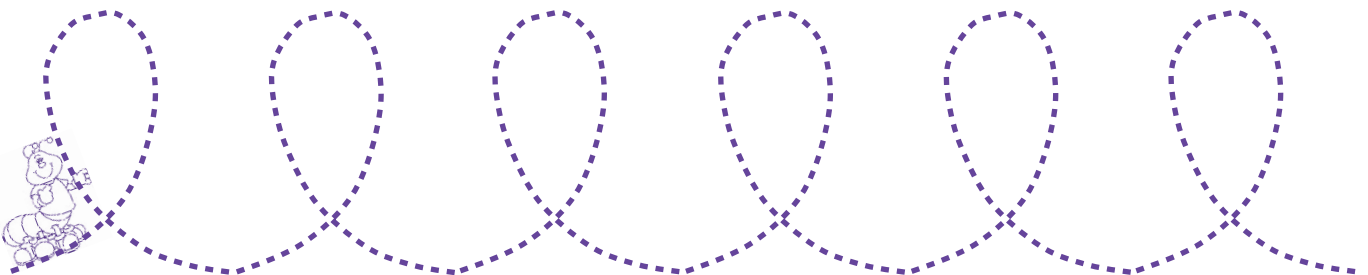
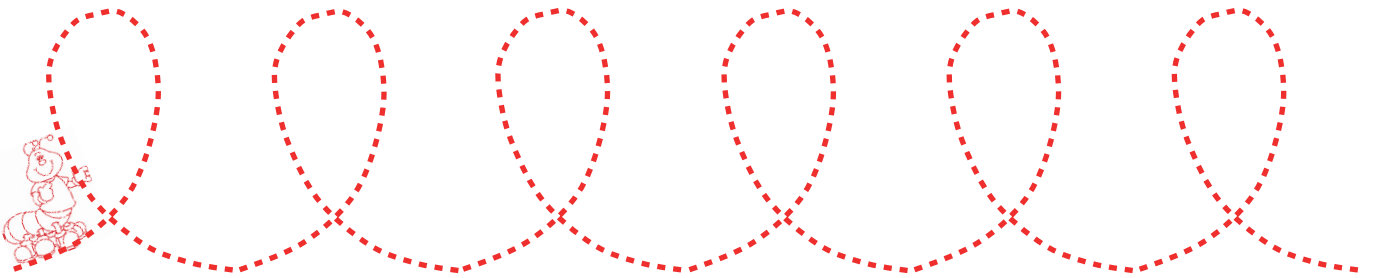
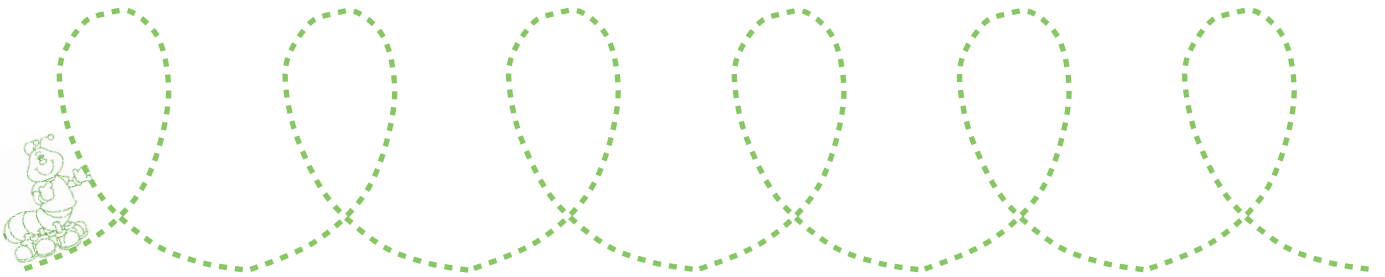
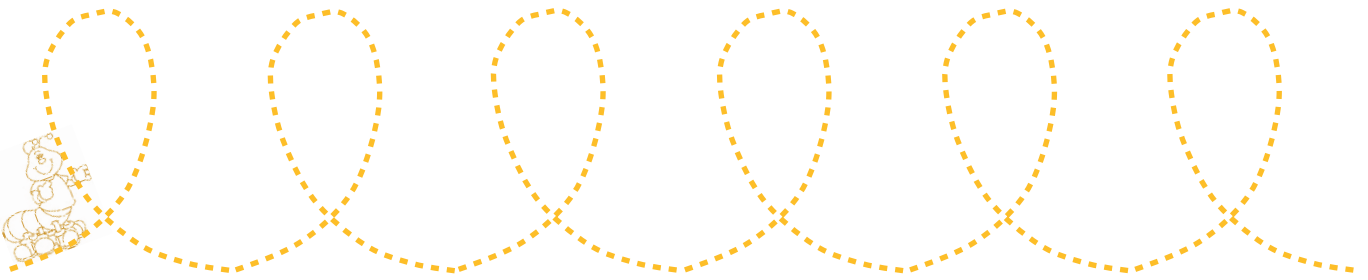
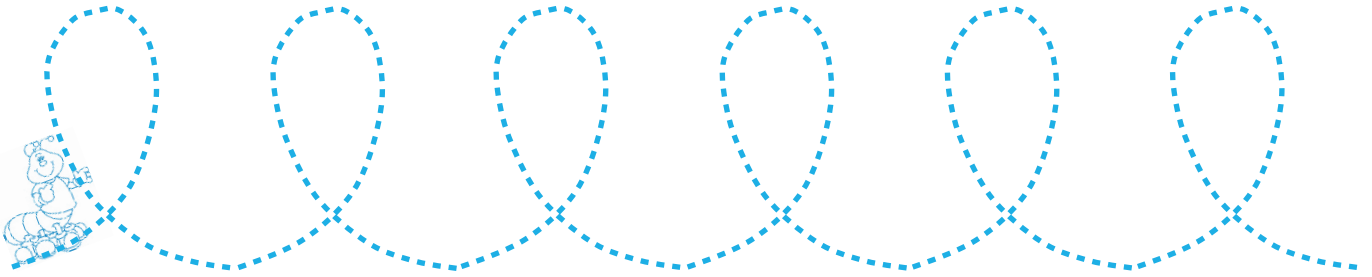

Nombre:

Fecha:

**Actividad 07:** Colorea las figuras que tienen forma de triángulos.

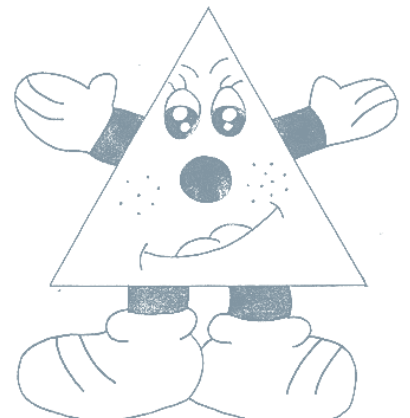
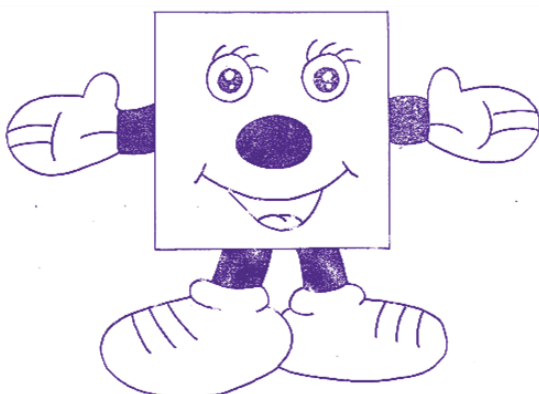
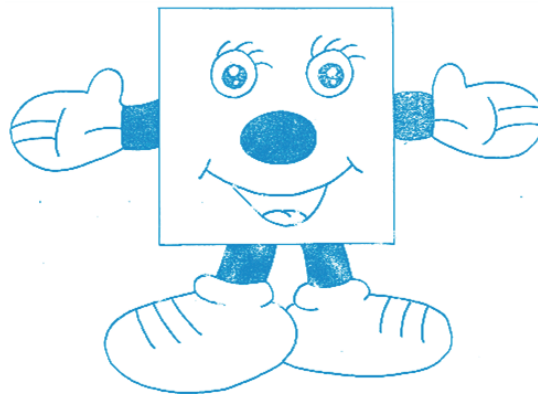
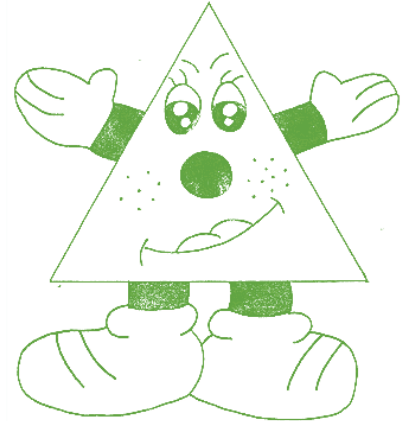
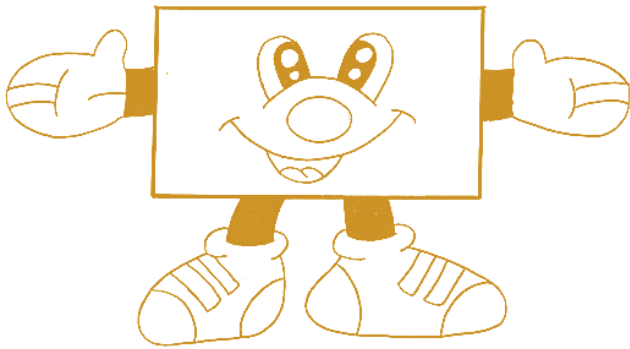
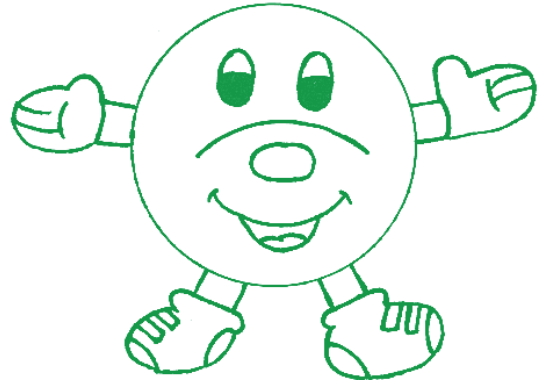
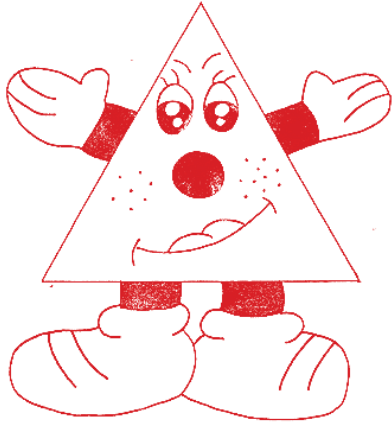



Nombre:

Fecha:

**Actividad 08:** Une con una línea los objetos semejantes y píntalos.

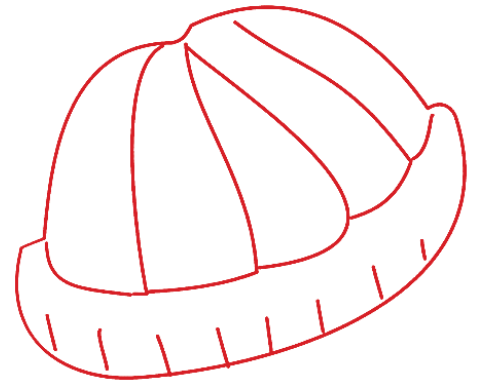









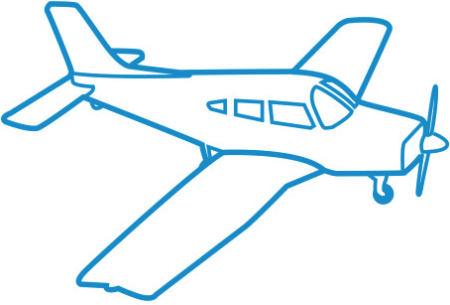

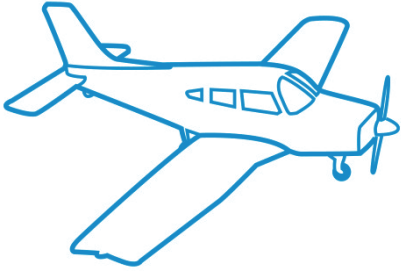
Nombre: \_\_\_\_\_

Fecha: \_\_\_\_\_

**Actividad 10:** Colorea los dibujos y marca con un aspa los más pequeños.

		
		
		

Nombre:

Fecha:



**Actividad 11:** Continúa las cenefas.

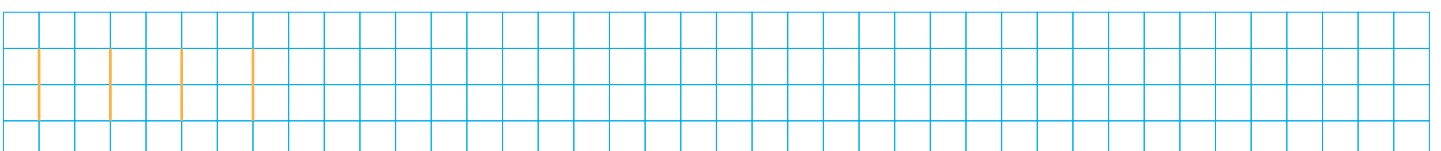
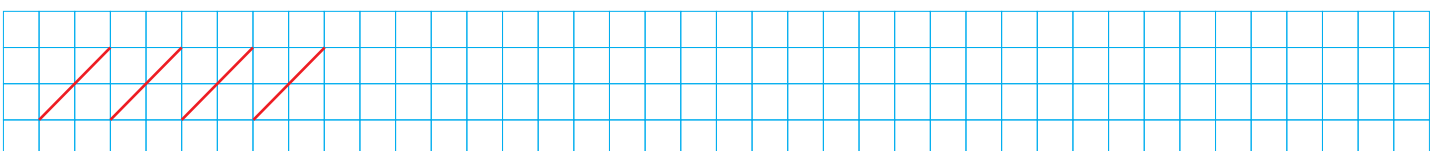
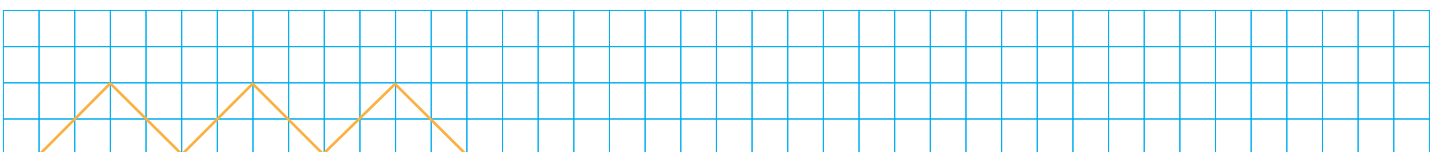
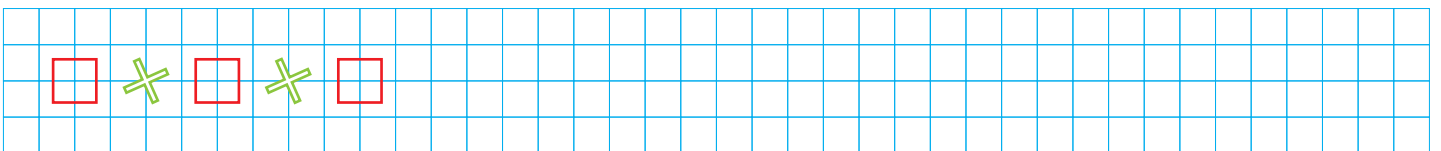
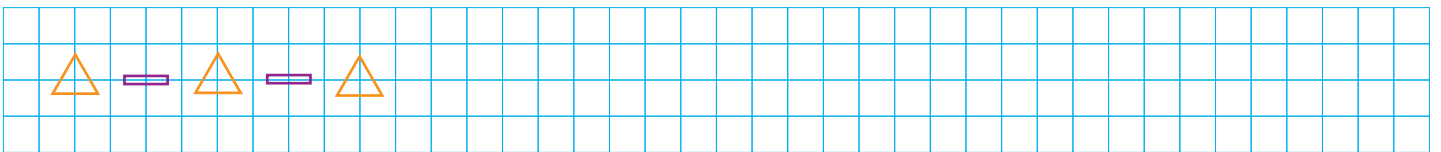
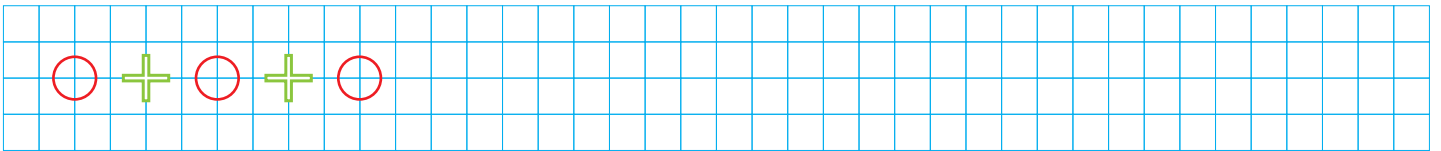
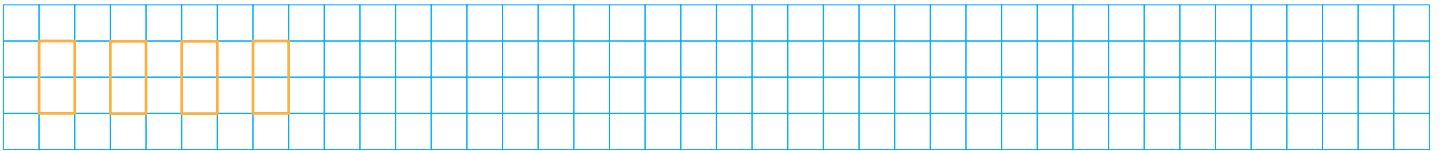
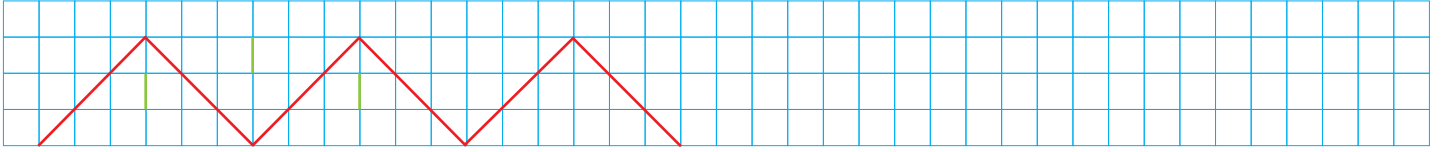

Nombre:

Fecha:



**Actividad 12:** Une los dibujos con su número y luego, colorea.

1



2



3



4



5



6

Nombre:

Fecha:

**Actividad 13:** Delinea las figuras y colorea según la clave.

1  
2  
3  
4

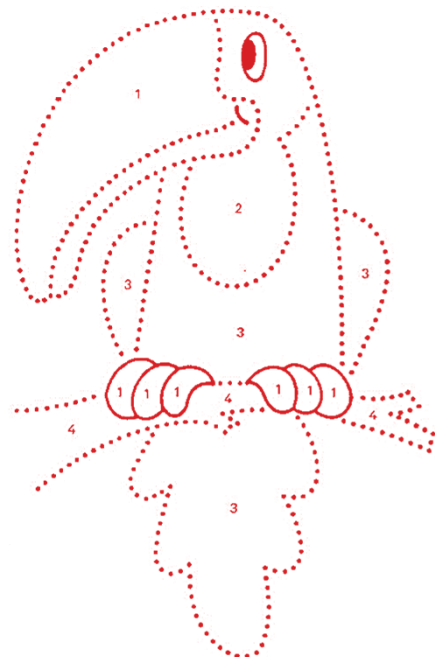
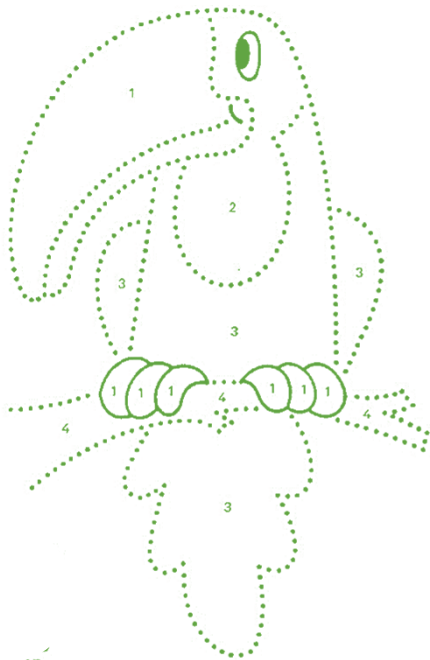
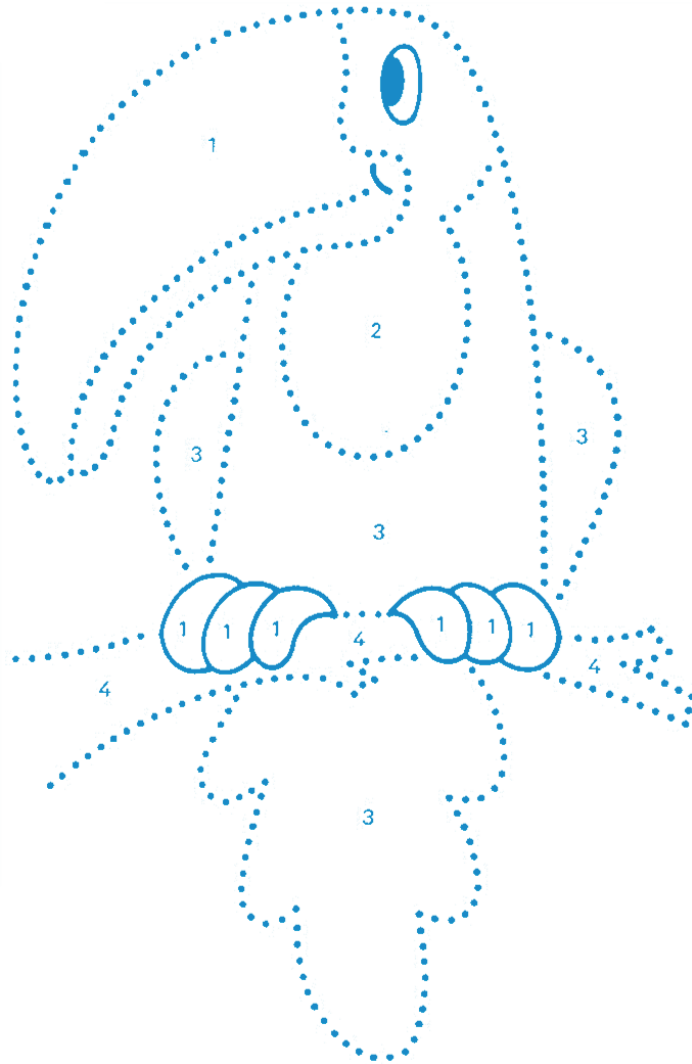

Nombre:

Fecha:

**Actividad 14:** Colorea de rojo las cosas de aseo y de azul las de vestir.

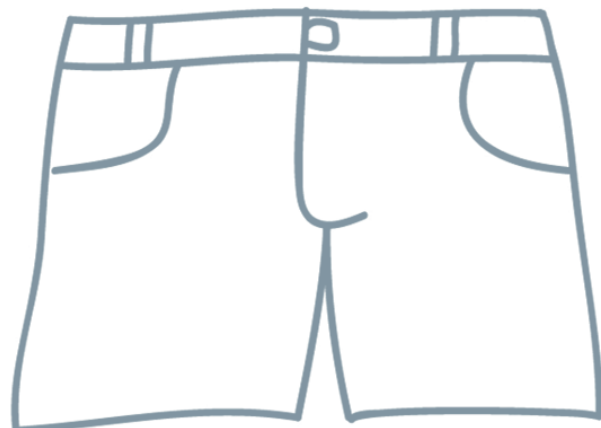
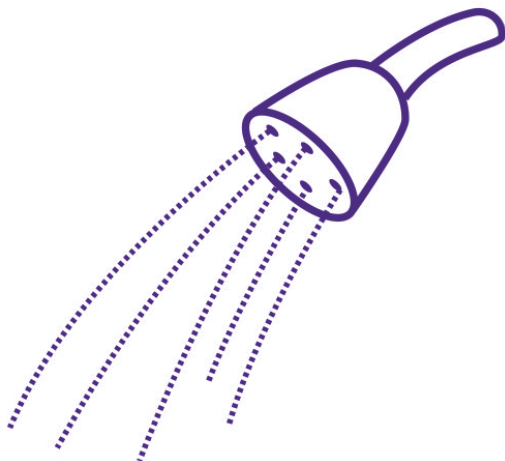
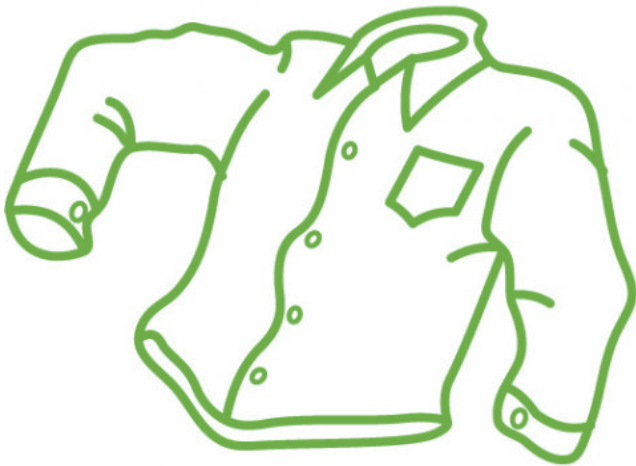

Nombre:

Fecha:

**Actividad 15:** Une los recuadros que tienen igual cantidad de figuras y colorea.

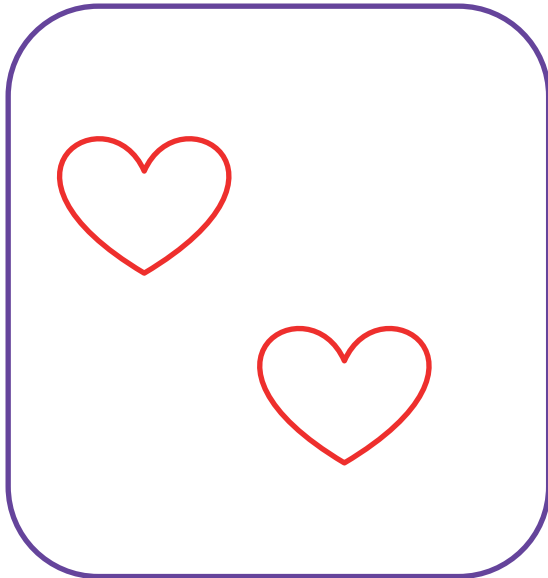
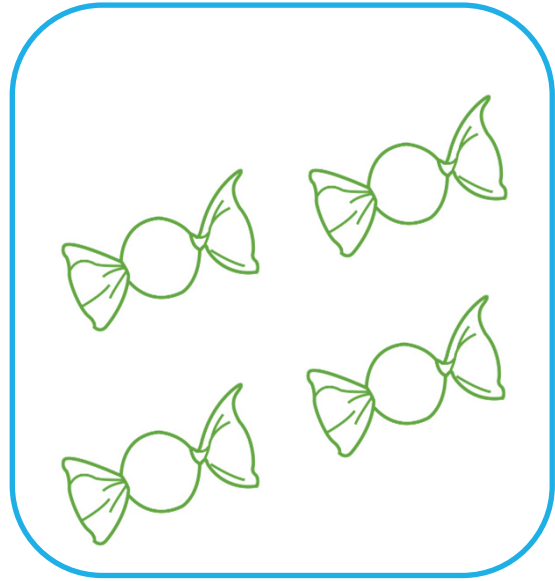
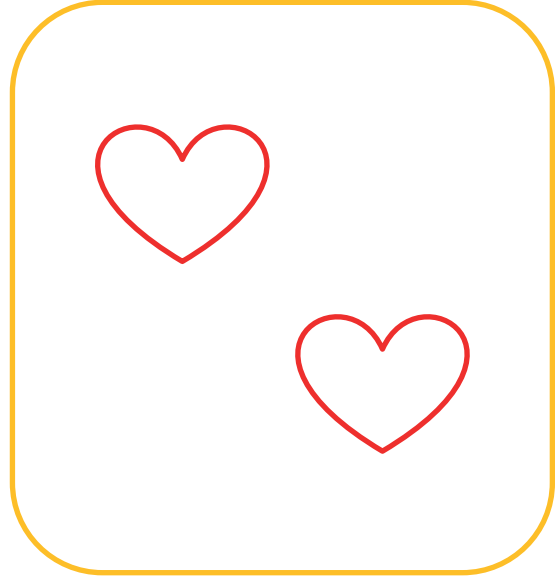
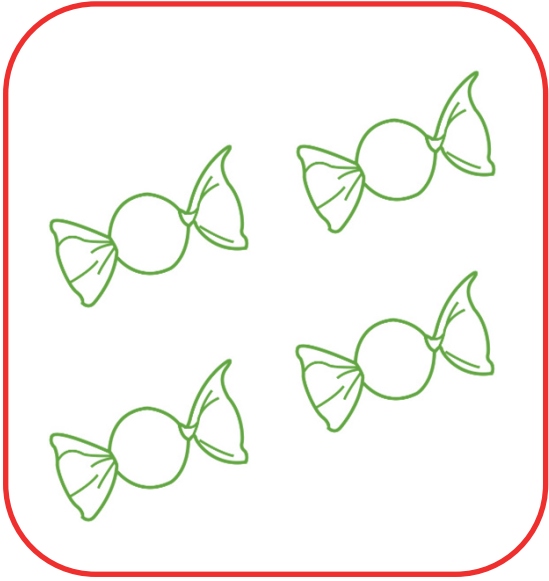



Nombre:

Fecha:

**Actividad 16:** Delinea, colorea de rosa el animal que vuela y de azul el que nada.

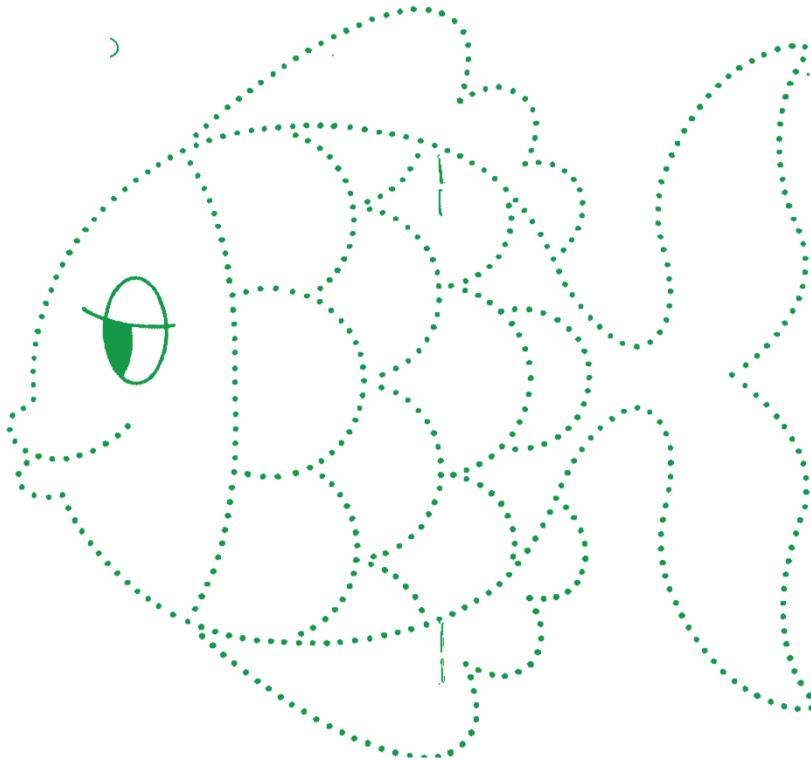
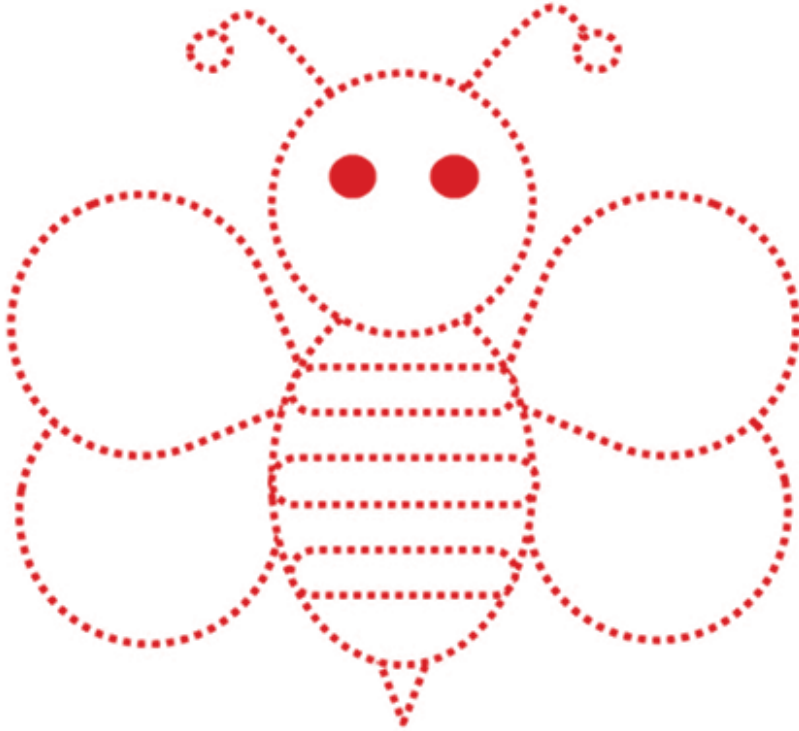

Nombre:

Fecha:

**Actividad 17:** Escribe en cada recuadro la cantidad de elementos que corresponda.

2

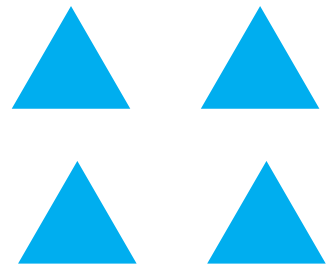
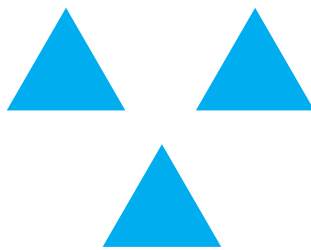
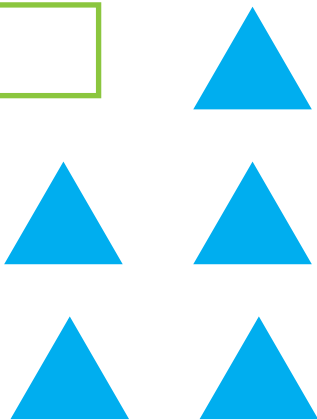
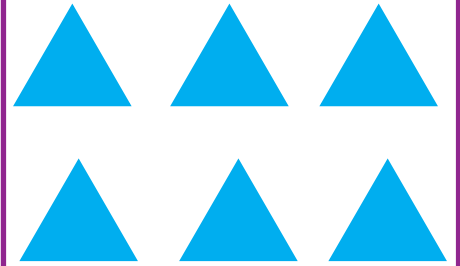
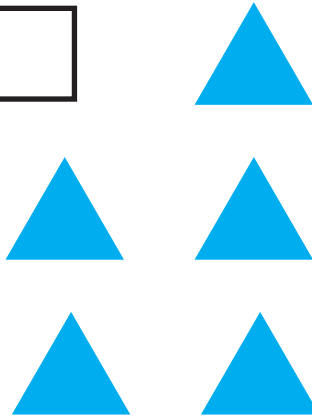
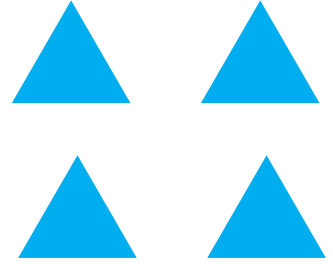
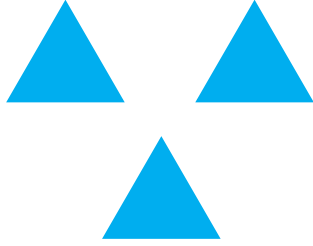
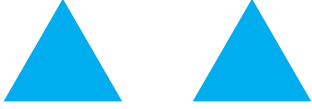

Nombre:

Fecha:

**Actividad 18:** Delinea las olas y colorea de rojo los peces que están nadando hacia arriba.

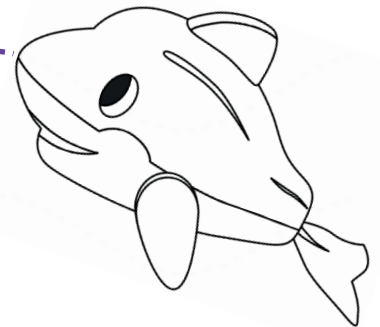
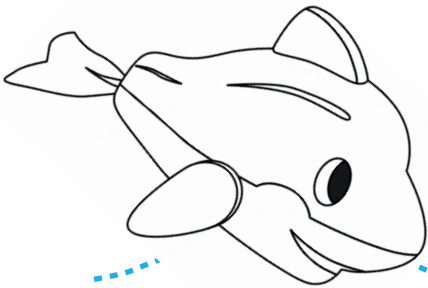
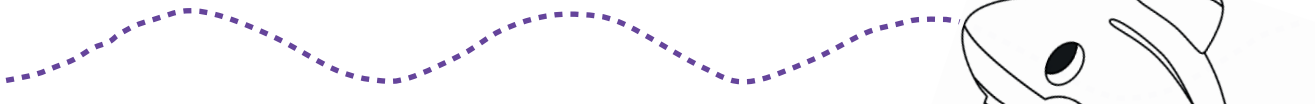
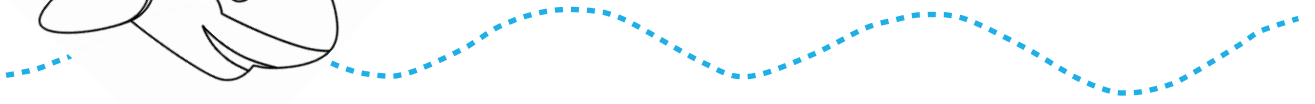
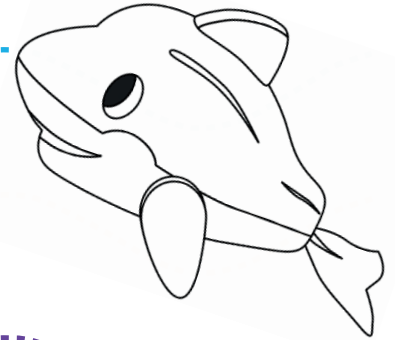
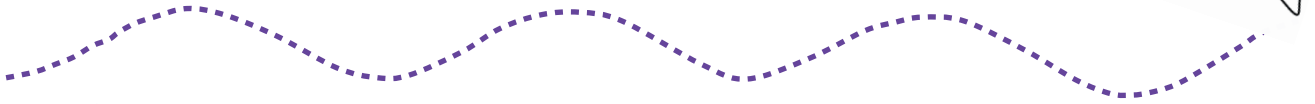
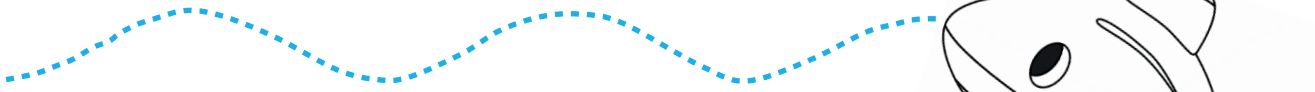

Nombre:

Fecha:

**Actividad 19:** Repasa los puntos de los conejos y colorea según la clave.

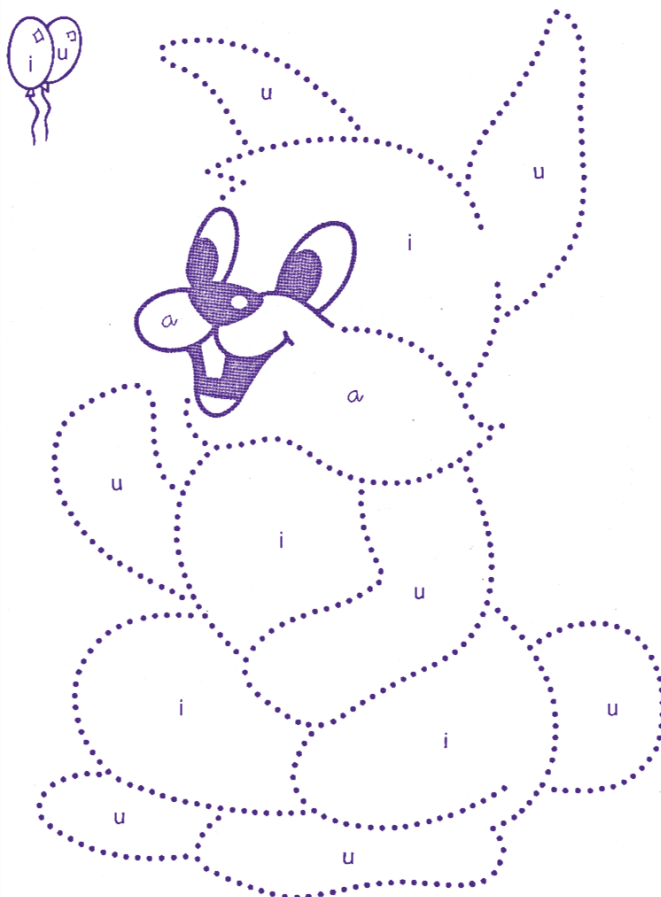
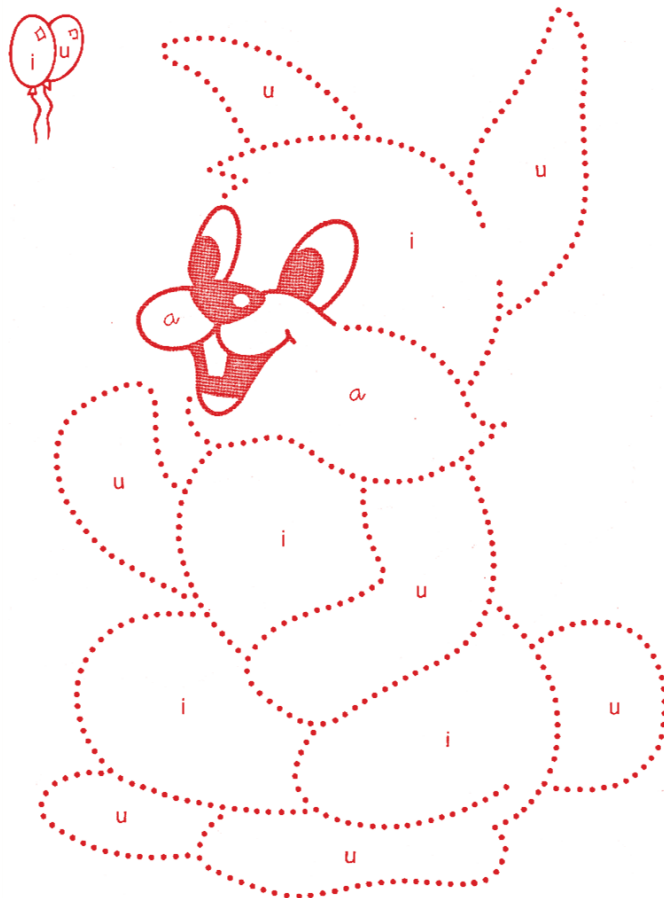

a. Blanco

i. Gris

u. Rosa

# Grafomotricidad



www.materialdeaprendizaje.com



Cuadernillo

1

4 años

Nombre:

Fecha:

## Actividad 01



### Punteado dentro de límites

Decora la torta utilizando plumones para hacer puntitos de muchos colores.



Nombre:

Fecha:

## Actividad 02



### Punteado dentro de límites

Decora las croyolas con puntos de colores. Utiliza plumones.

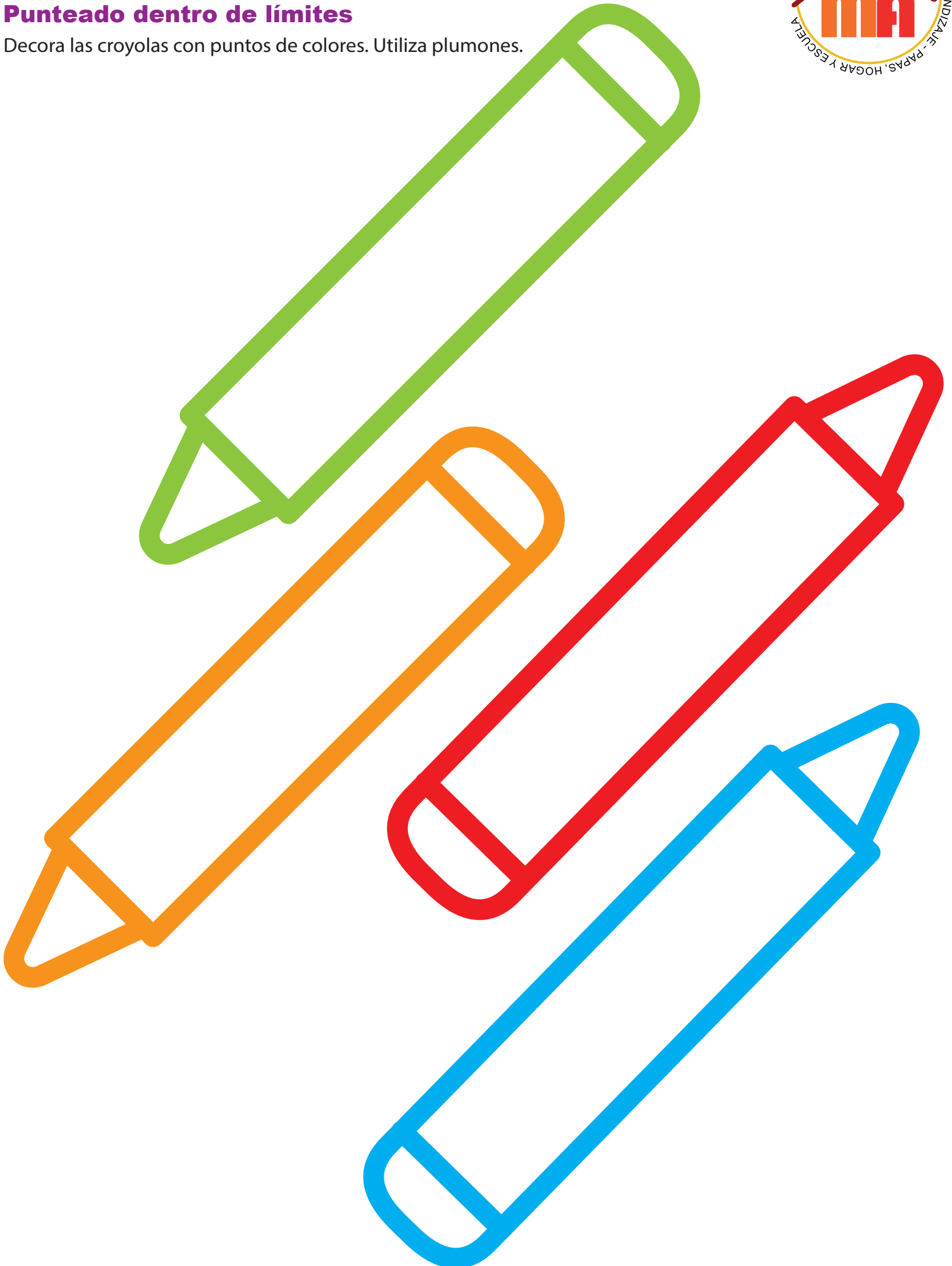

Nombre:

Fecha:

### Actividad 03



### Punteado dentro de límites

Completa con puntos las fresas. Utiliza plumones.

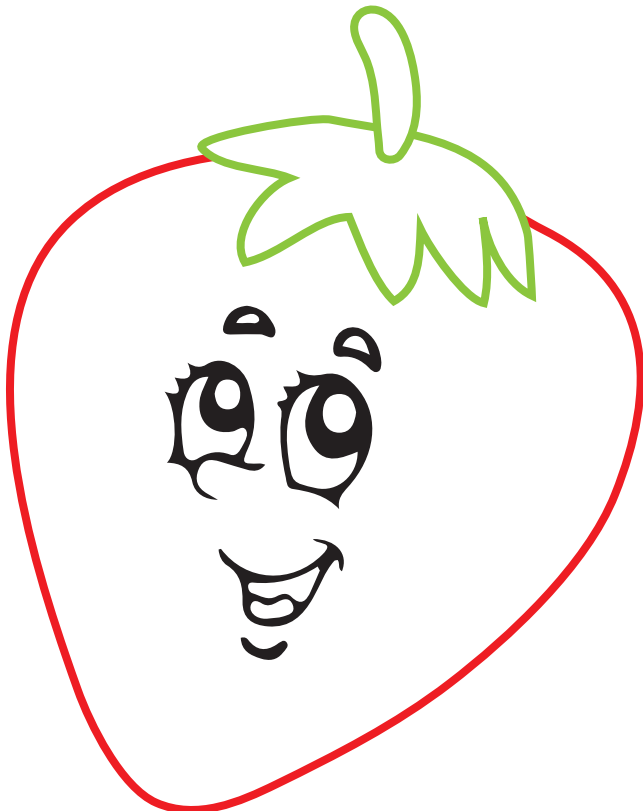
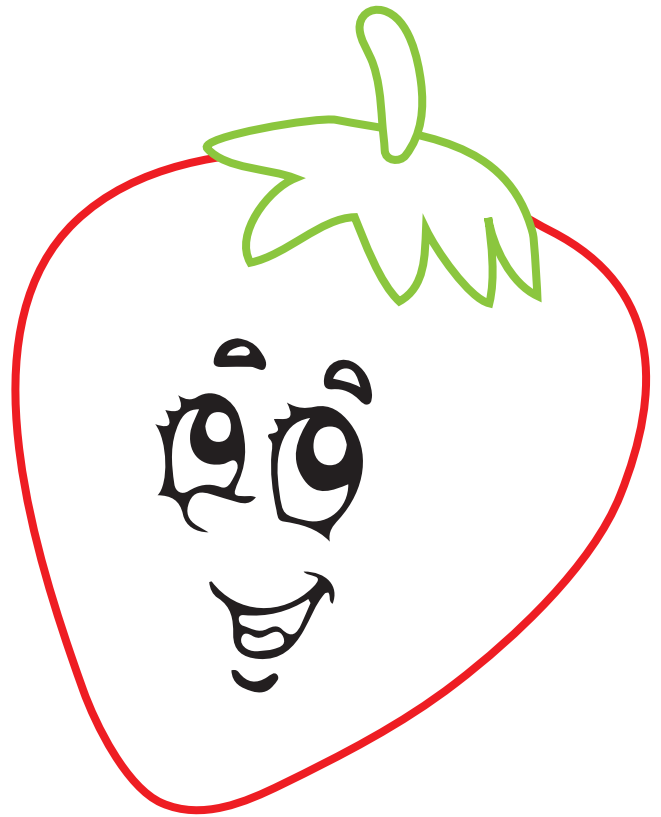
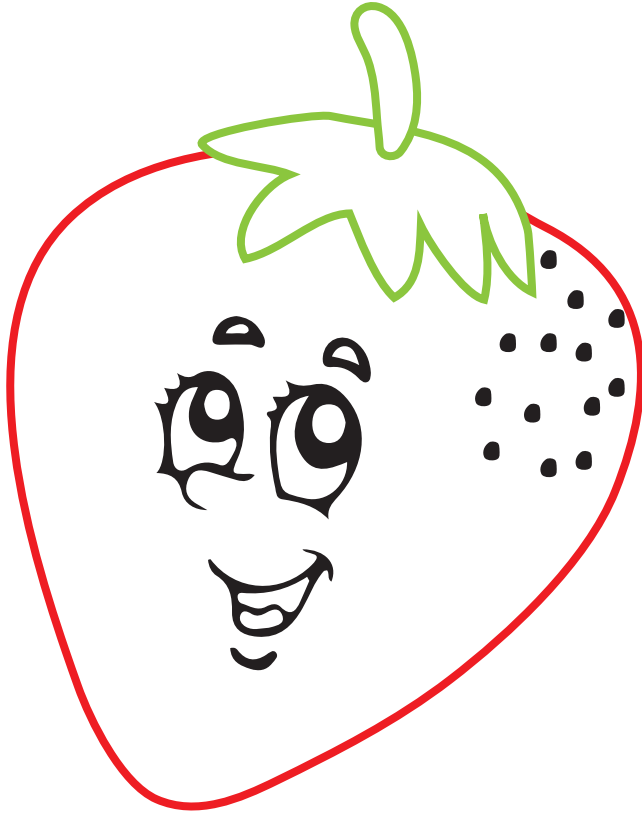



Nombre:

Fecha:

## Actividad 04



### Delineado de líneas rectas horizontales

Traza el camino que recorrerá el niño para anotar un gol.

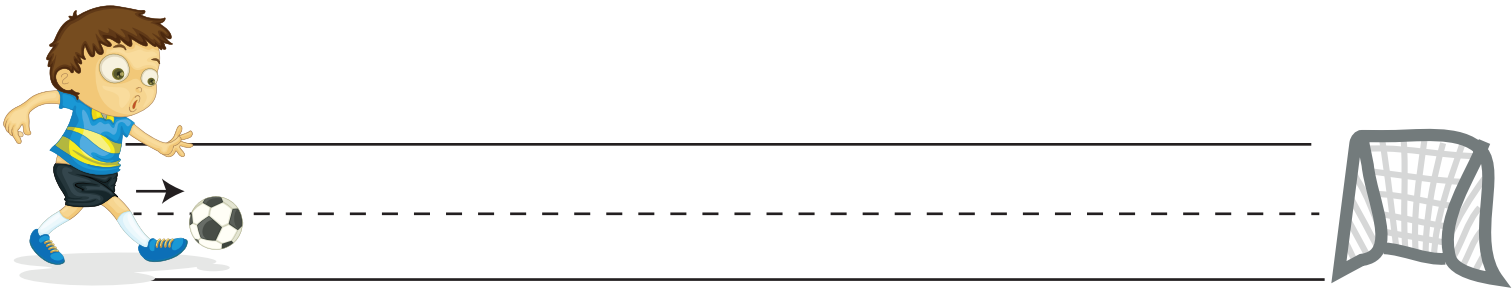
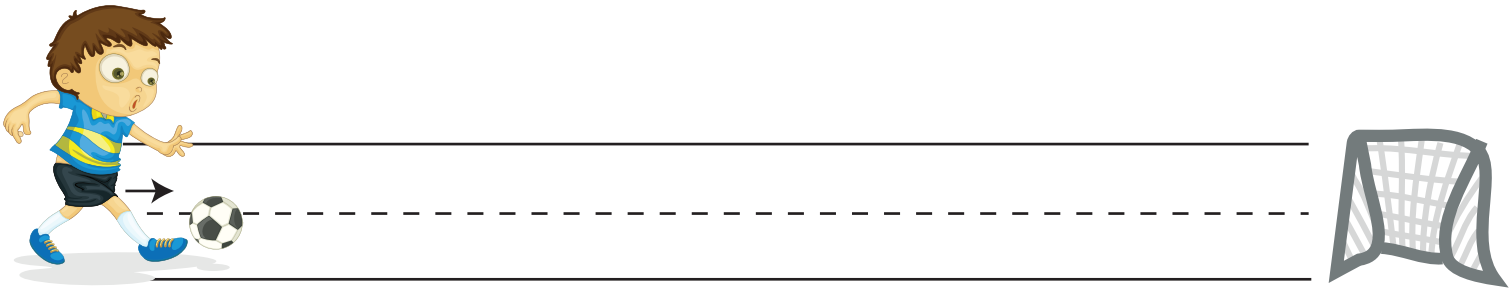
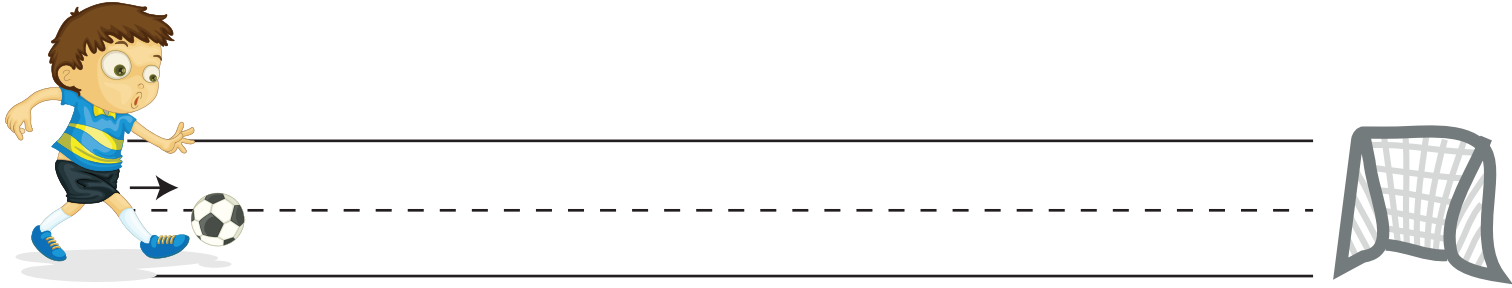
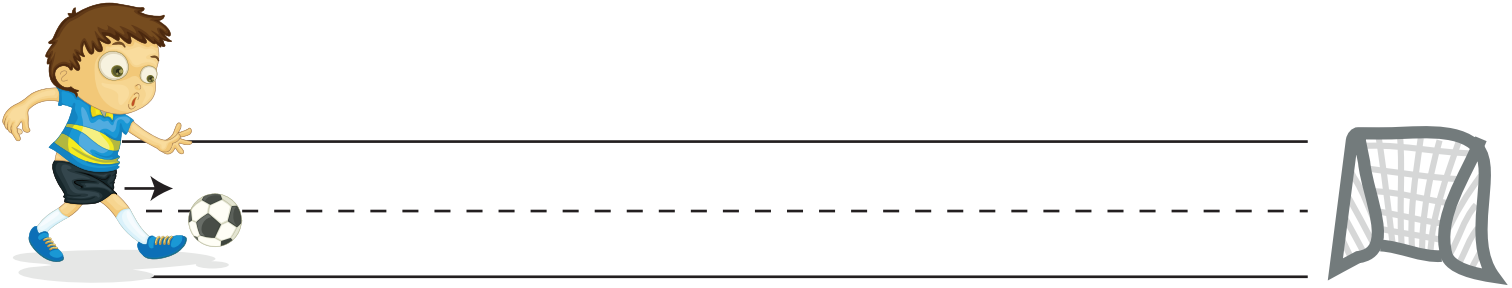

Nombre:

Fecha:

## Actividad 05



### Abolillar y pegar

Abolilla papel crepé y pégalos en el camino que lleva a casa.

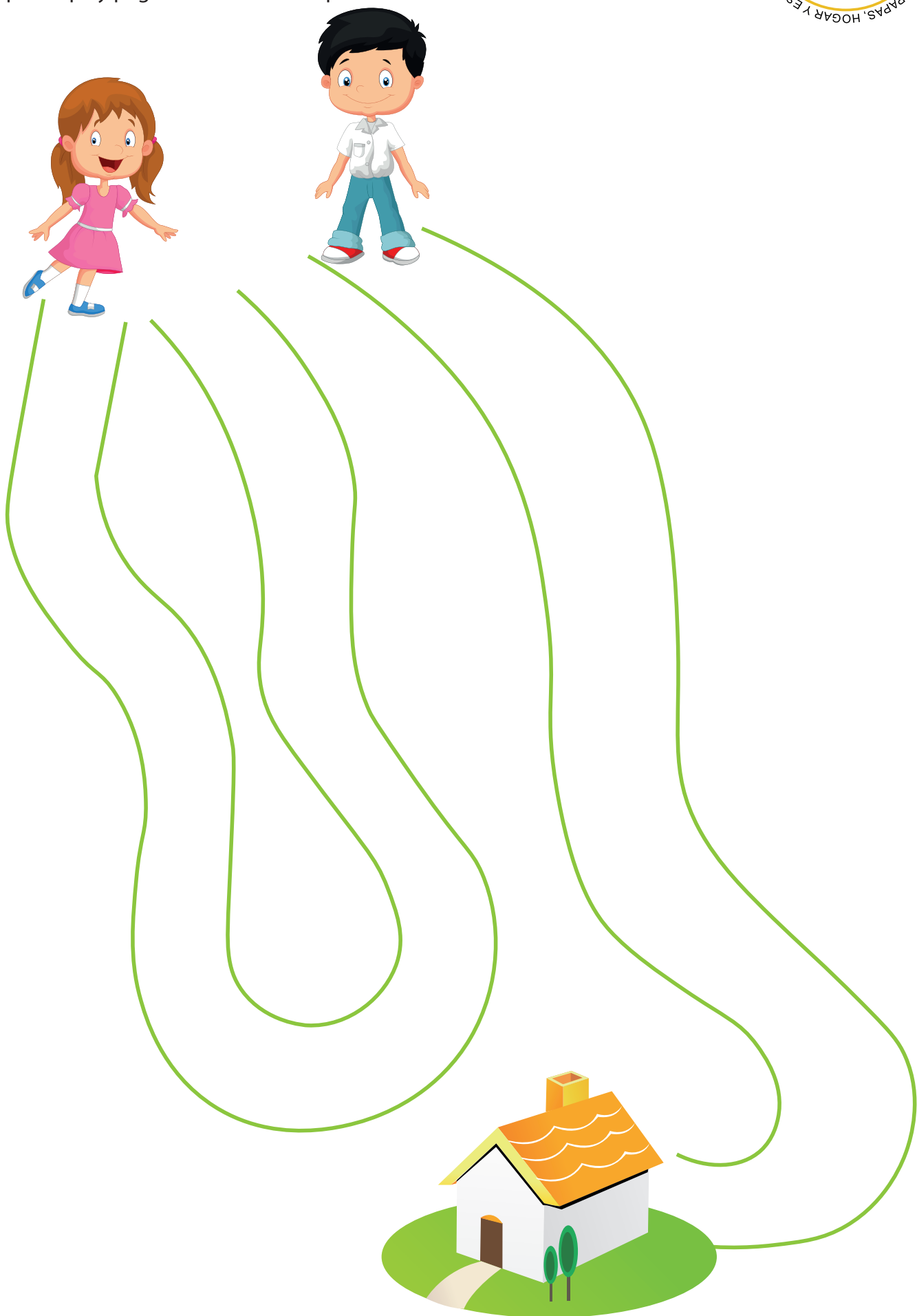

Nombre:

Fecha:

## Actividad 06



### Trazado ondeado en caminos

Traza los caminos para ayudar a los gusanitos a llegar a las manzanas.

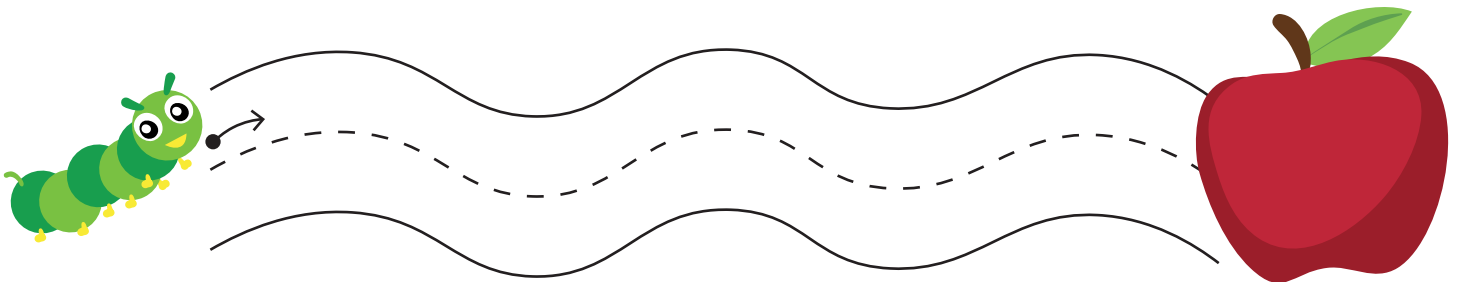
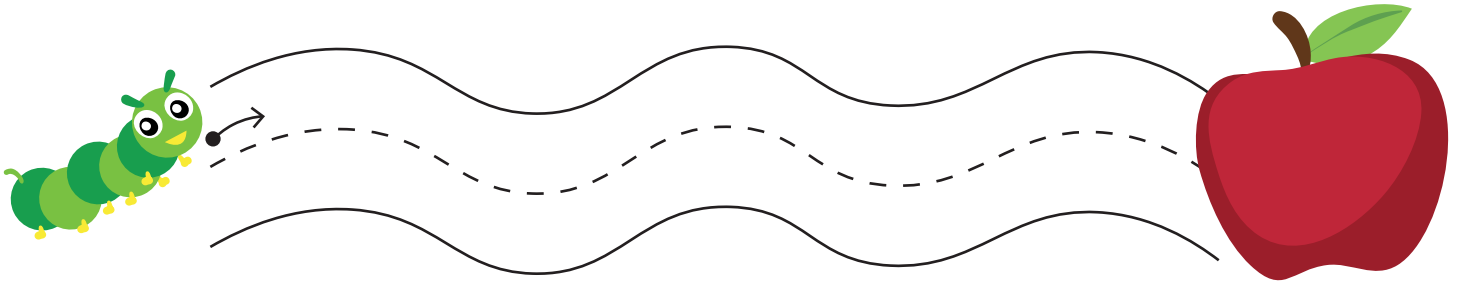
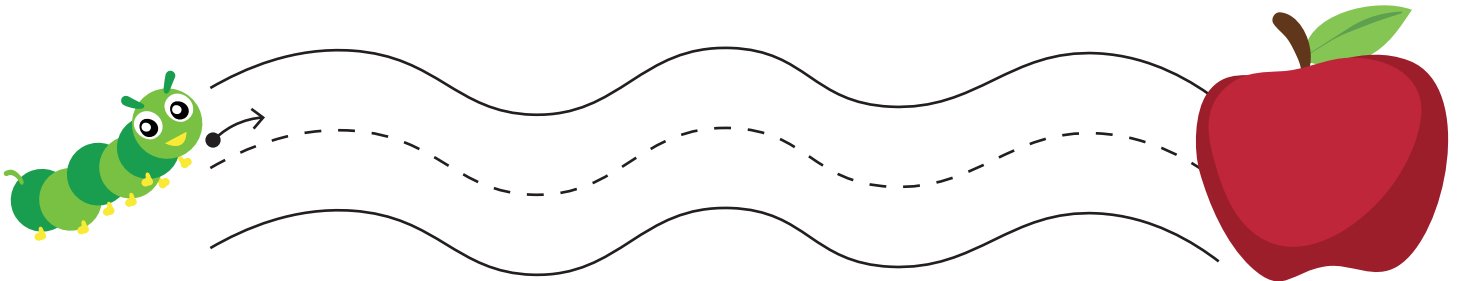
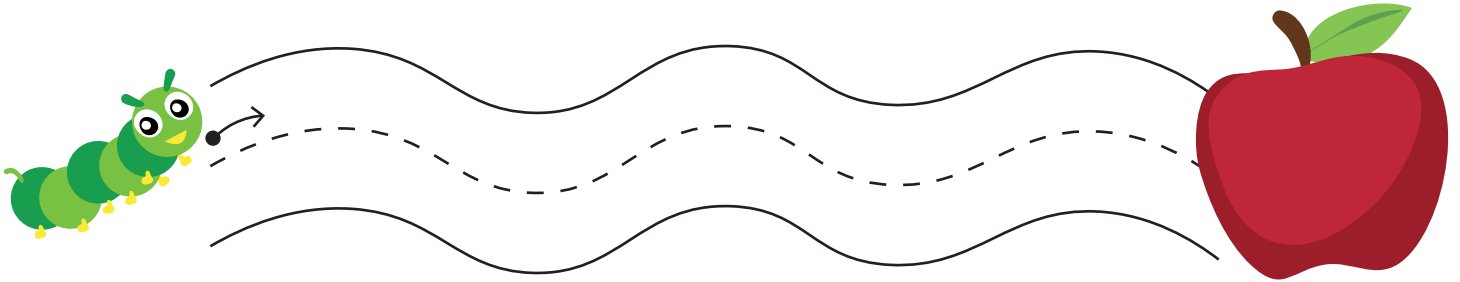

Nombre:

Fecha:

### Actividad 07



### Trazado libre

Traza el camino de la serpiente a la canasta.

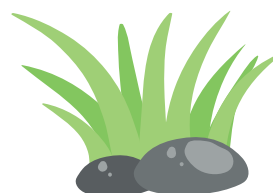
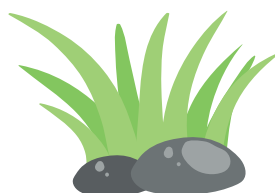
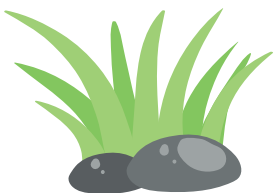
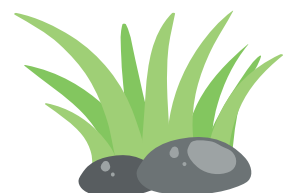
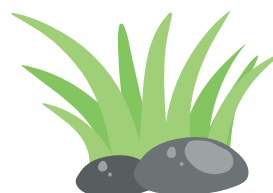
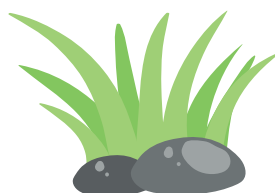
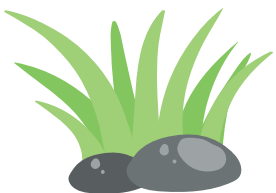
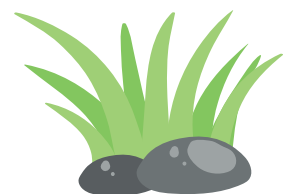
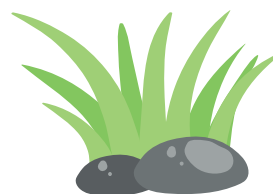
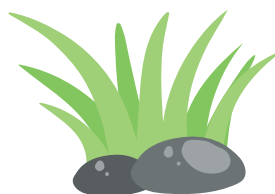
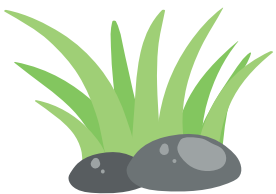
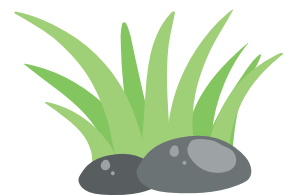
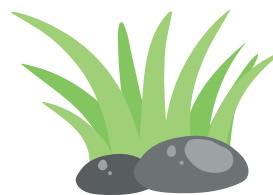
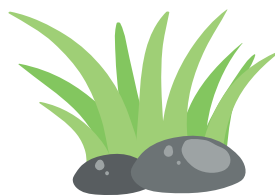
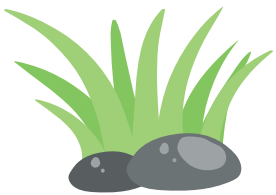
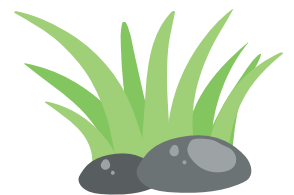
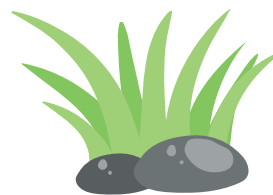
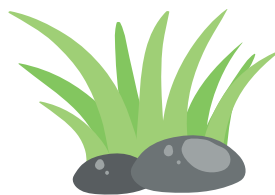
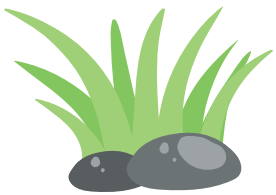
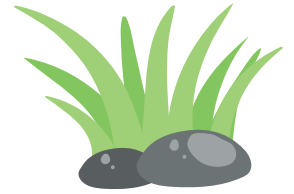
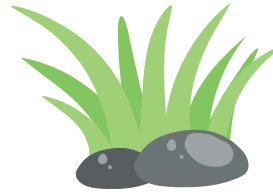
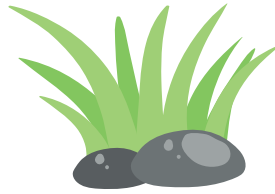

Nombre:

Fecha:

## Actividad 08



### Delineado en zigzag

Traza los caminos para ayudar a las hormigas a llegar a su casa.

Nombre:

Fecha:

## Actividad 09



### Delineado en caminos verticales y horizontales.

Ayuda a la mariquita a llegar a su hoja. Traza el camino.

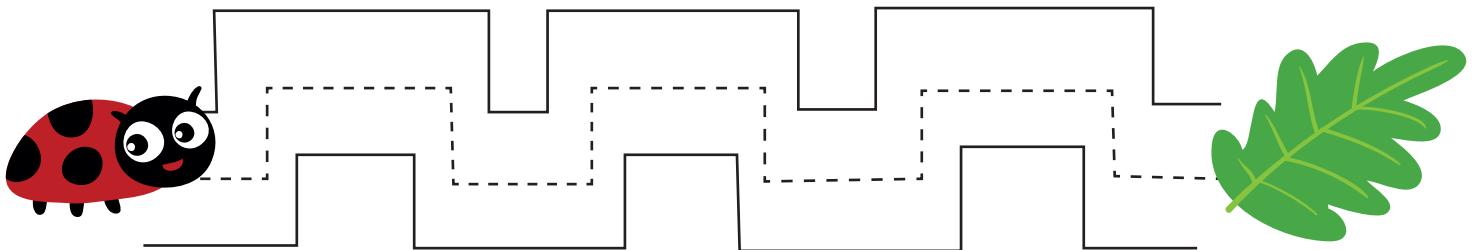
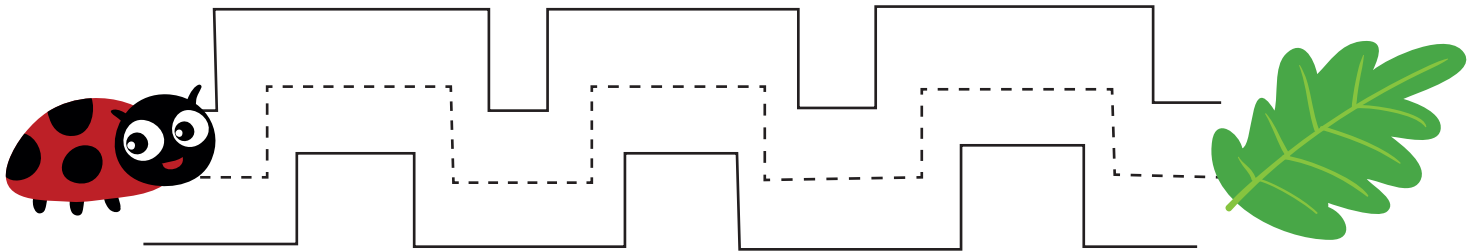
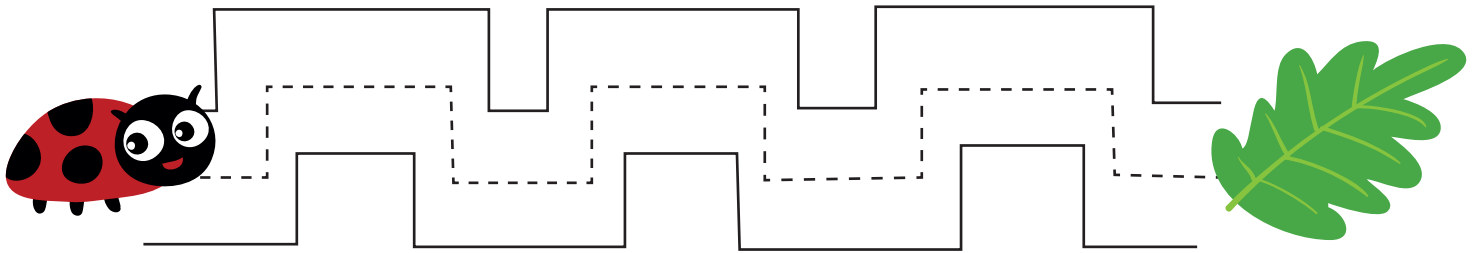
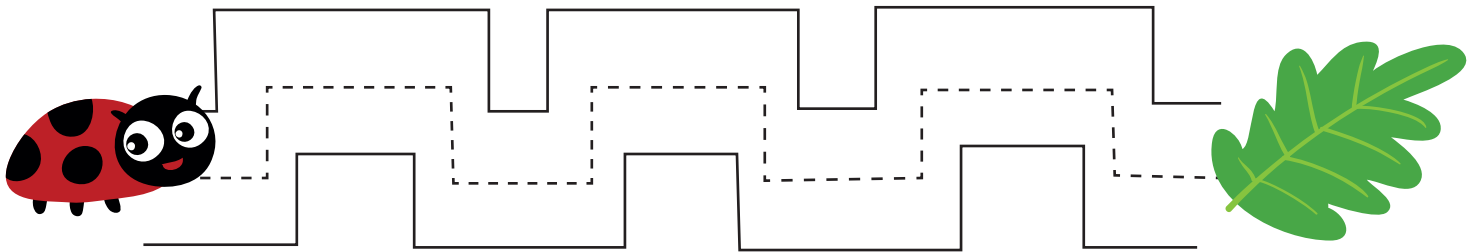
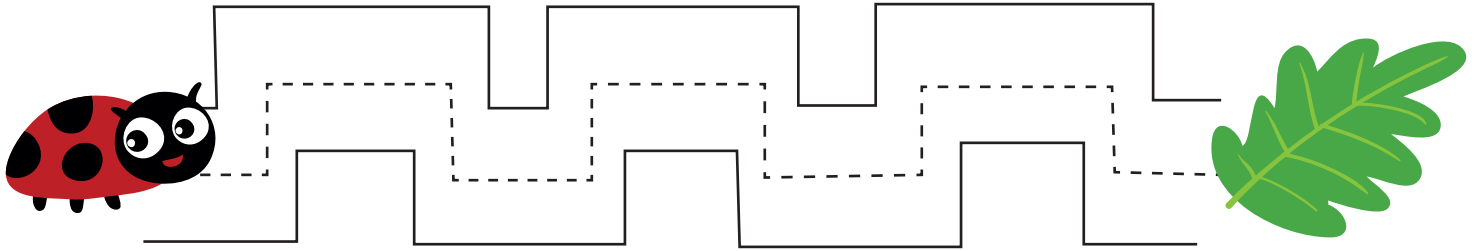

Nombre:

Fecha:

## Actividad 10



### Traza el camino

Ayuda al perrito a encontrar su hueso.

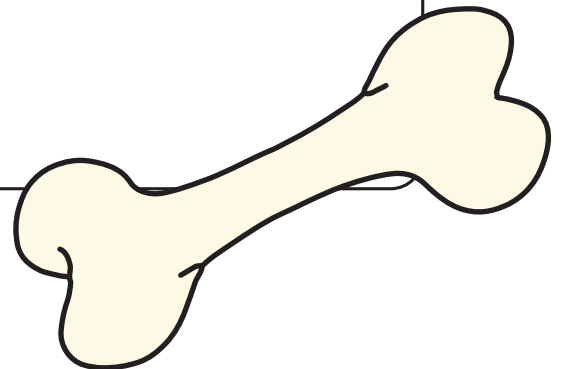
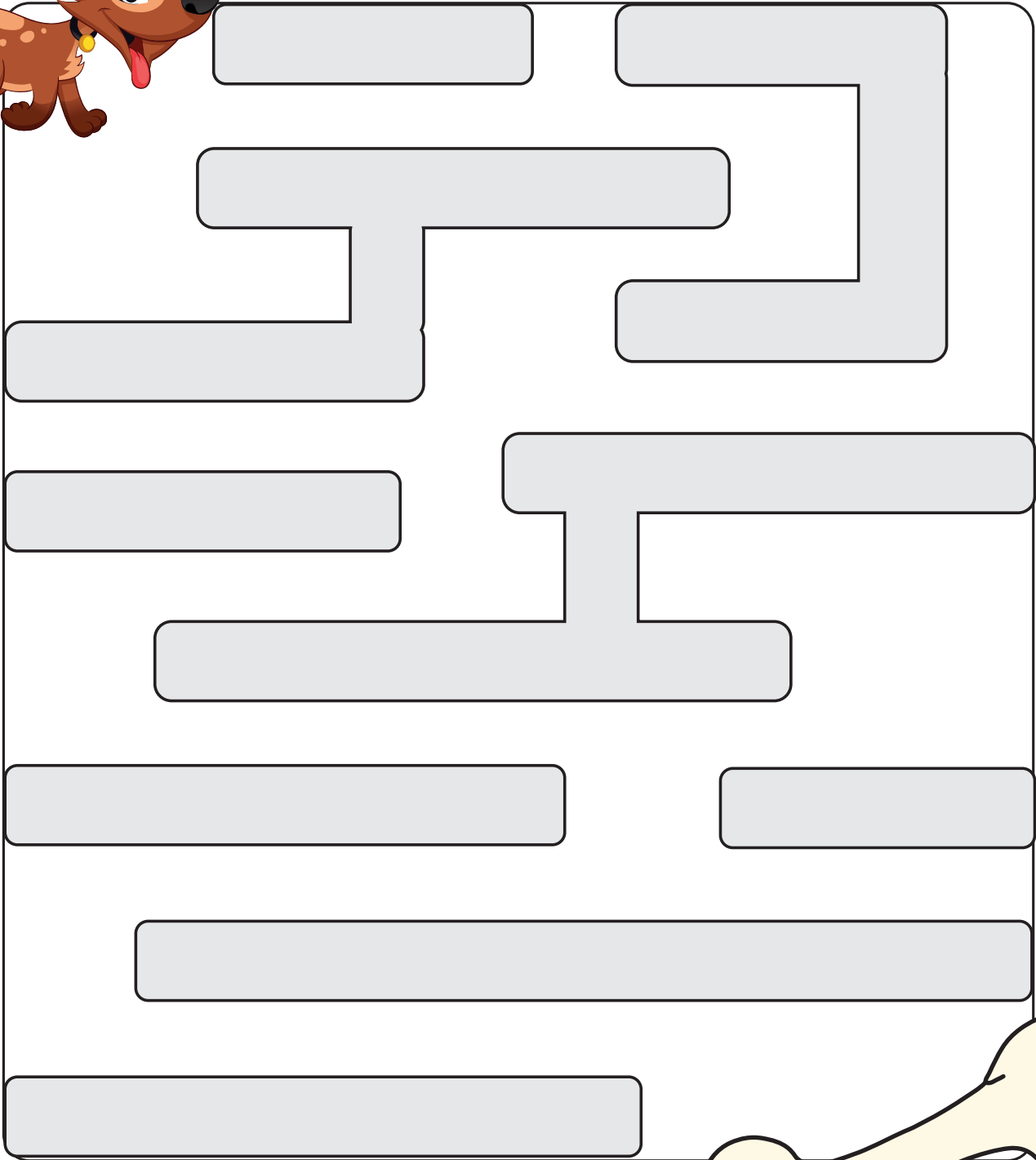

Nombre:

Fecha:

# Actividad 11



## Delineado de líneas rectas verticales

Delinea los tallos de las flores.

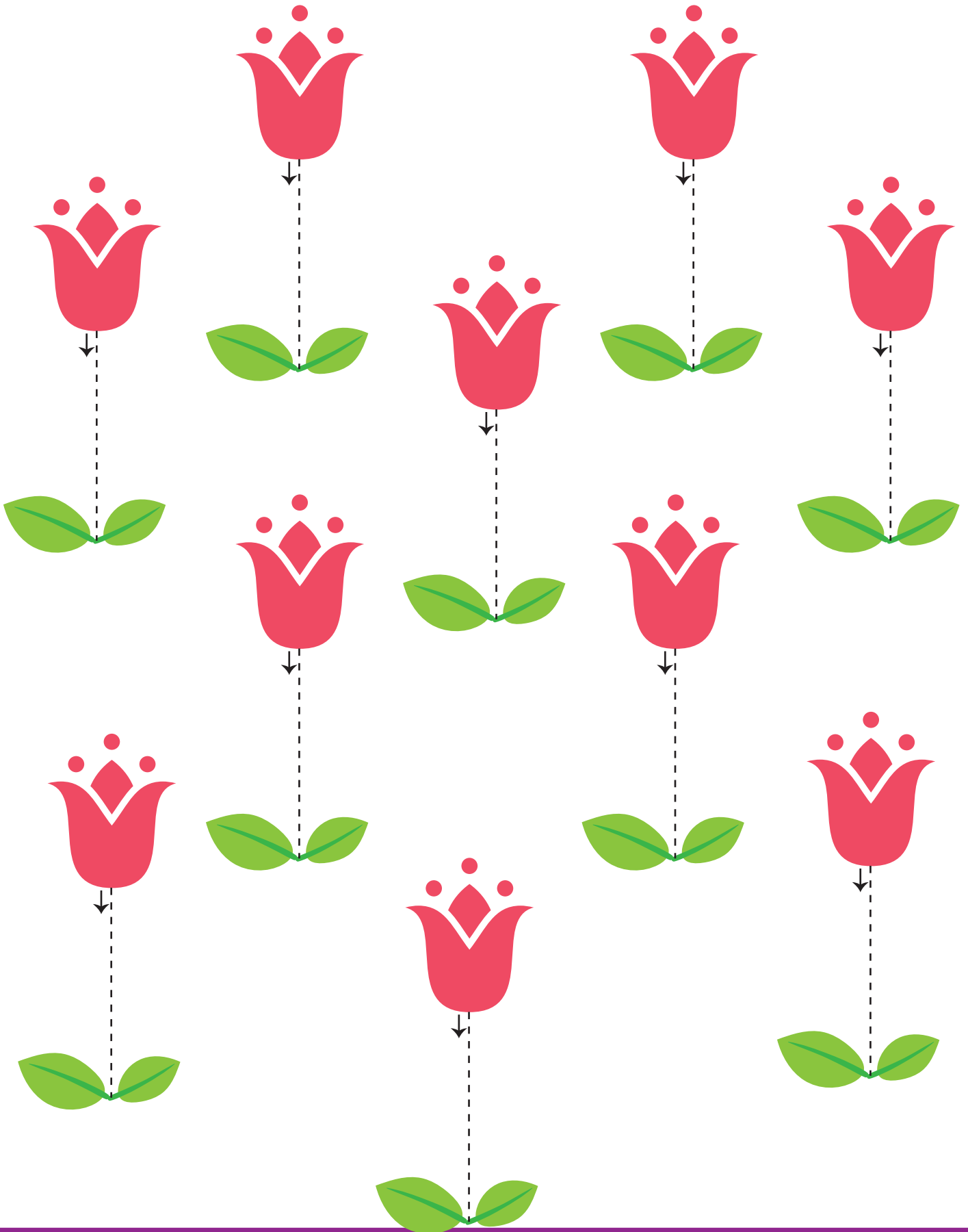



Nombre:

Fecha:

## Actividad 12



### Delineado de líneas rectas diagonales

Delinea las cerdas de los peines.

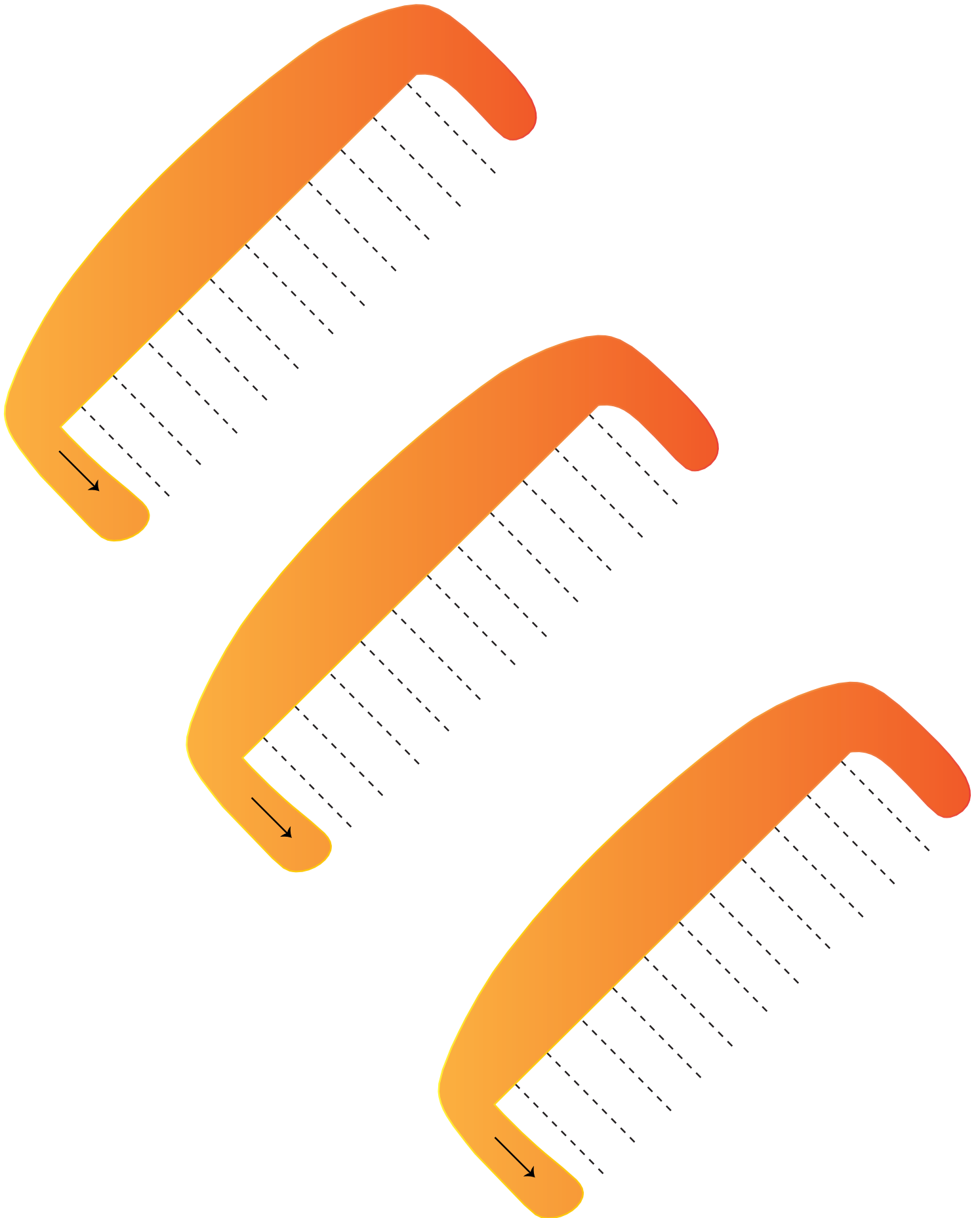

Nombre:

Fecha:

### Actividad 13



## Delineado de líneas rectas diagonales

Delinea los lápices y coloréalos.

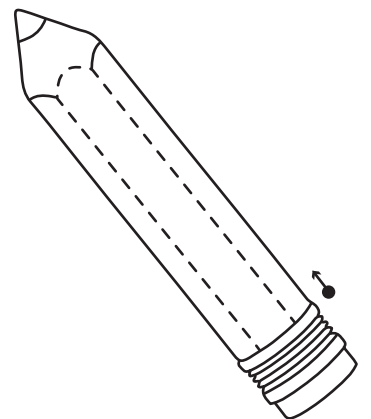
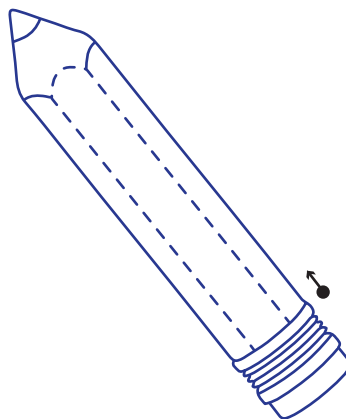
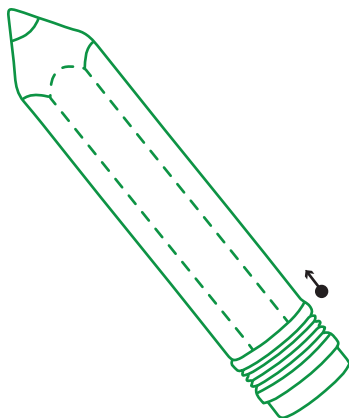
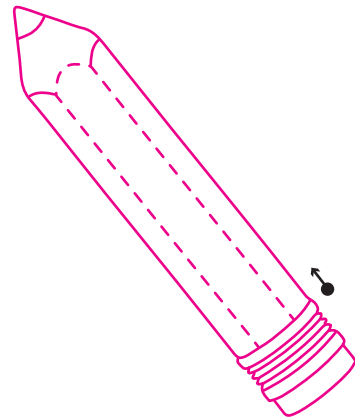
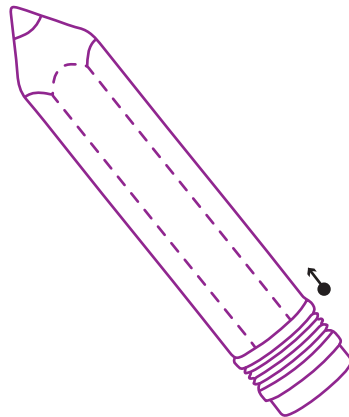
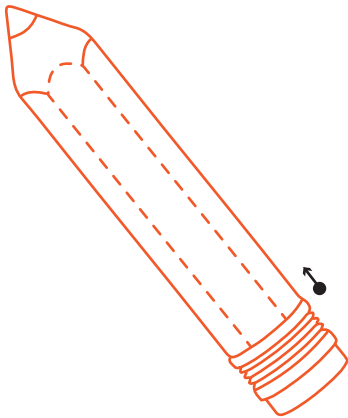
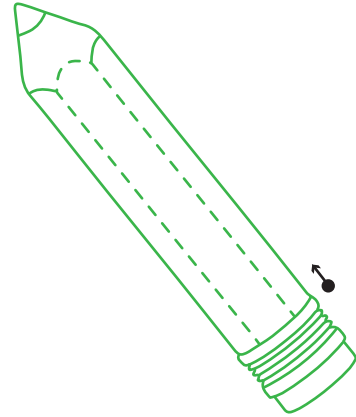
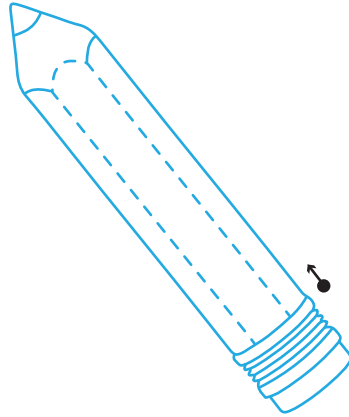
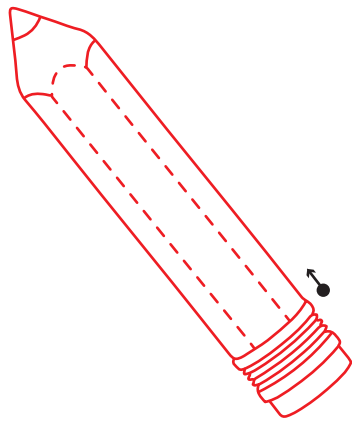

Nombre:

Fecha:

# Actividad 14



## Delineado en cruz

Delinea los cometas y coloréalos.

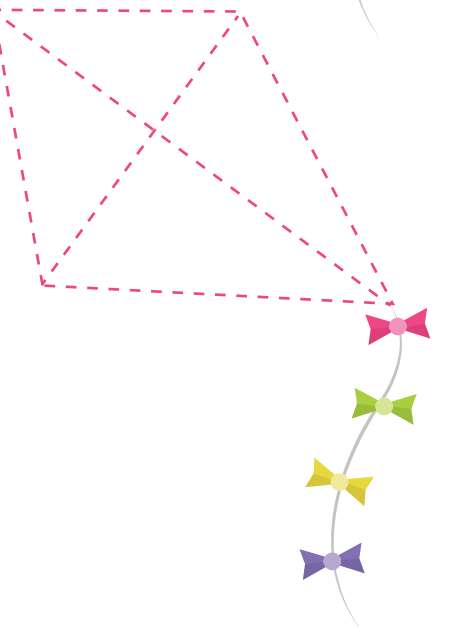
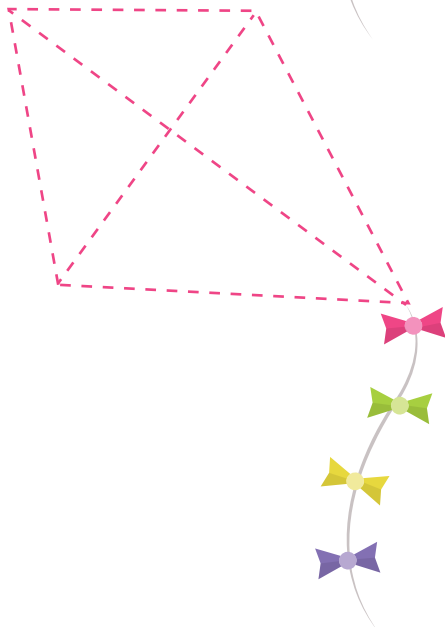
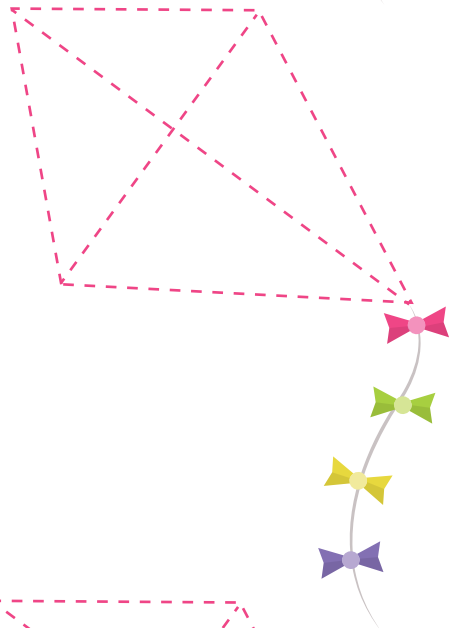
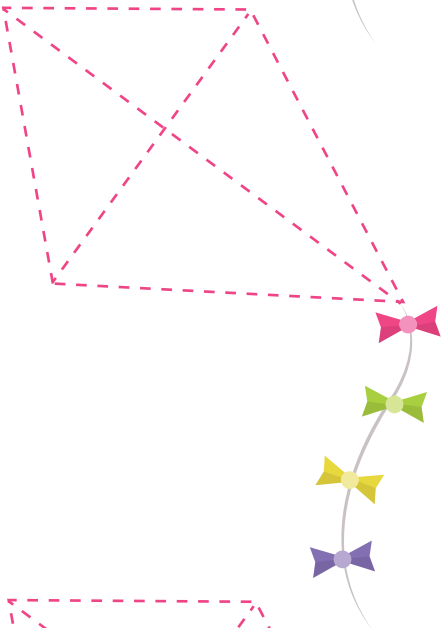
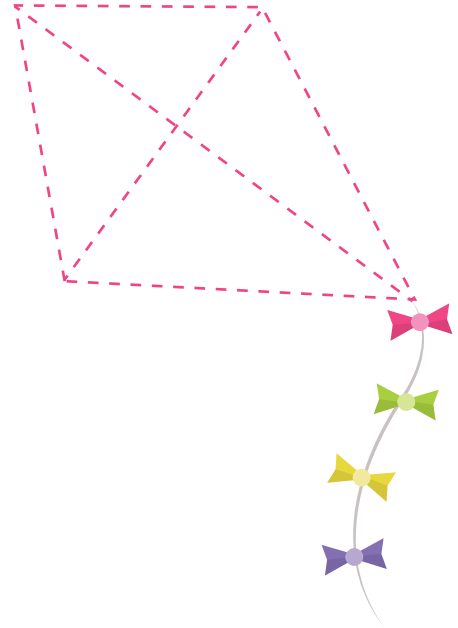
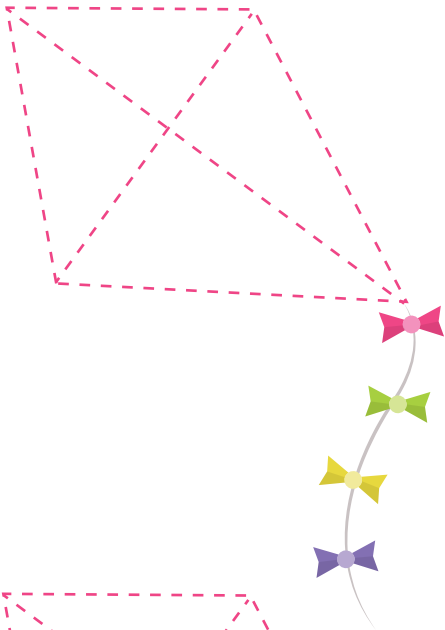

Nombre:

Fecha:

## Actividad 15



### **Delineado y trazado en líneas verticales y horizontales.**

Delinea el traje de Gabriela para colorearlo.

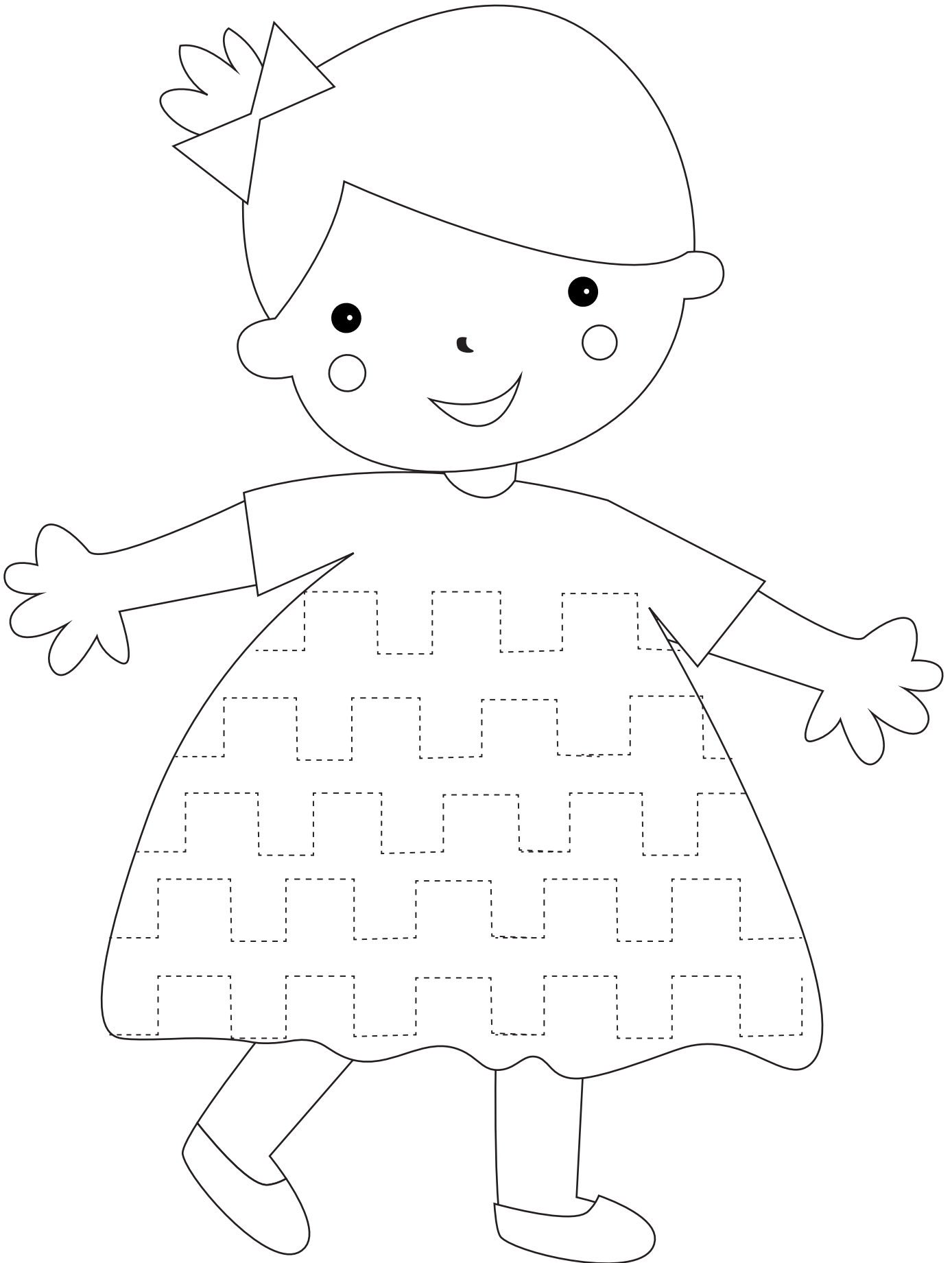

Nombre:

Fecha:

## Actividad 16



### Delineado de líneas curvas

Delinea el cuello de las garzas.



Nombre:

Fecha:

# Actividad 17



## Encuentra y traza el camino

Traza el camino hacia la casa.

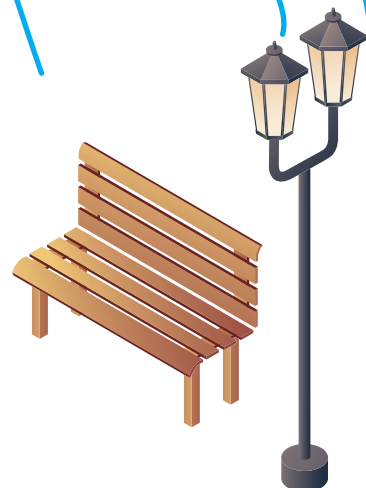
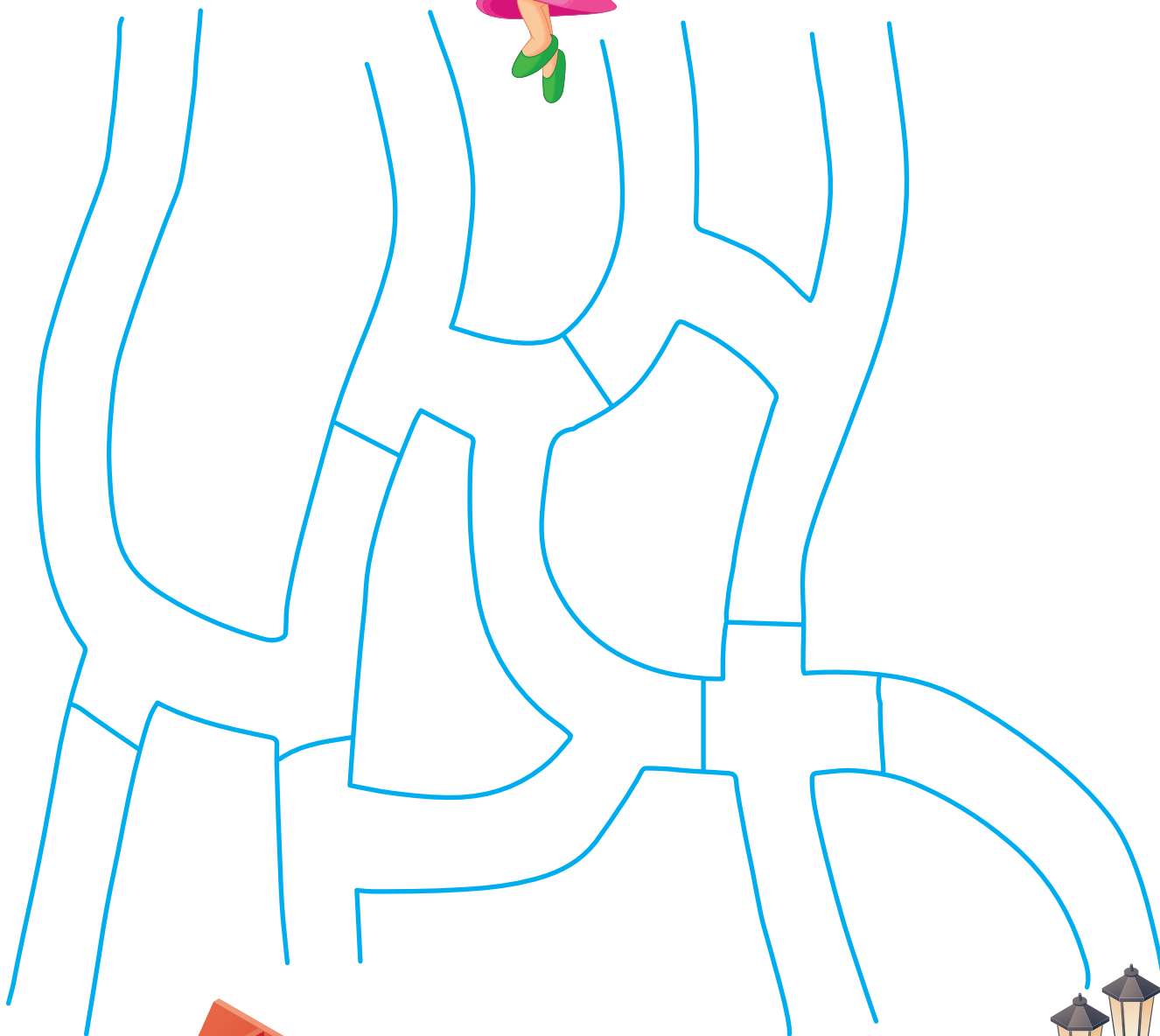

Nombre:

Fecha:

## Actividad 18



### Coloreado y recorte en tiras

Colorea cada velero de diferente color.

Recorta tiras de papel azul y pégalas, dándole color al mar.

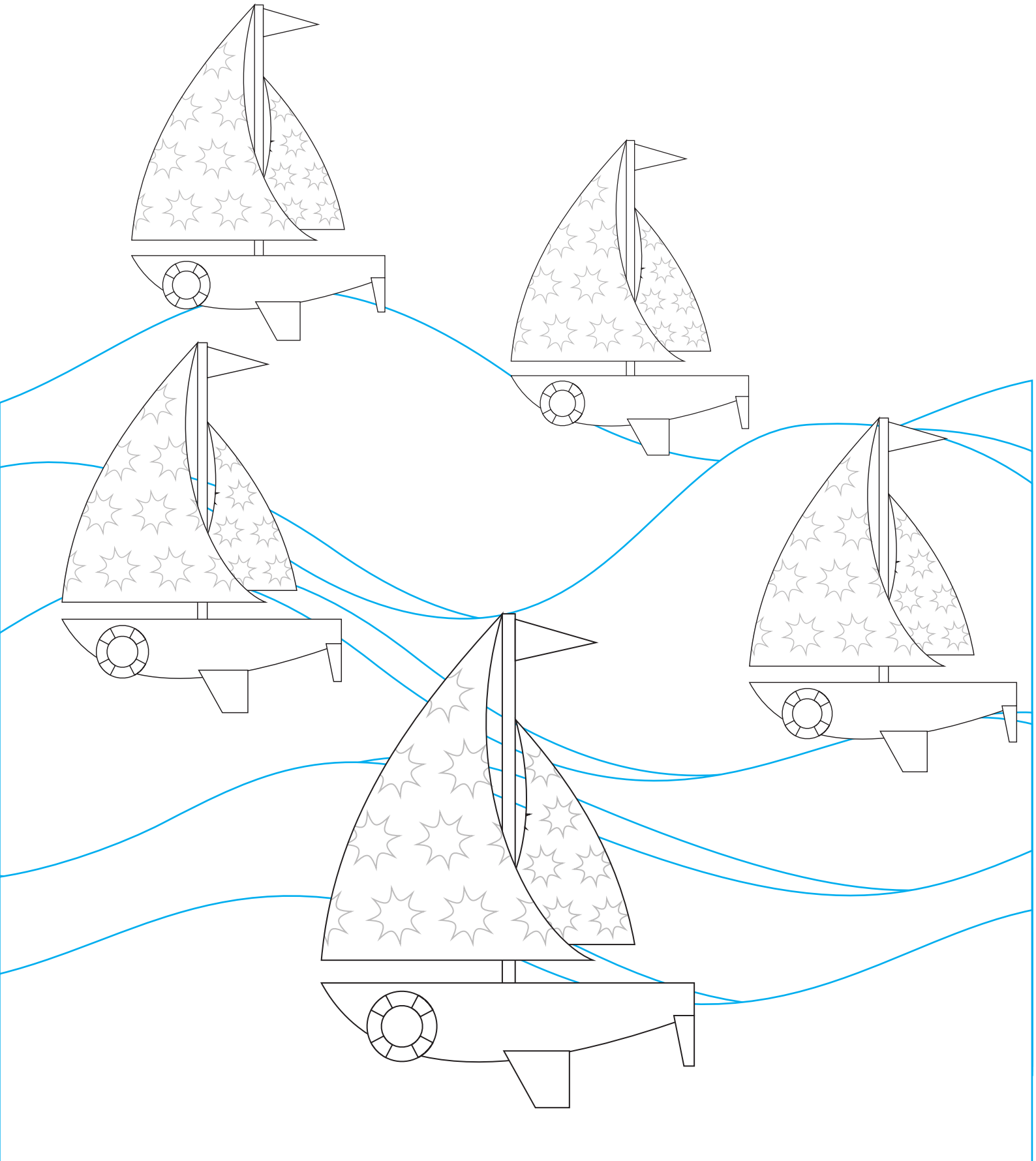

Nombre:

Fecha:

## Actividad 19



### Delineado circular y abolillado

Delínea todos los círculos de la ilustración. Luego, haz bolitas de papel y pégalas en las pelotas.

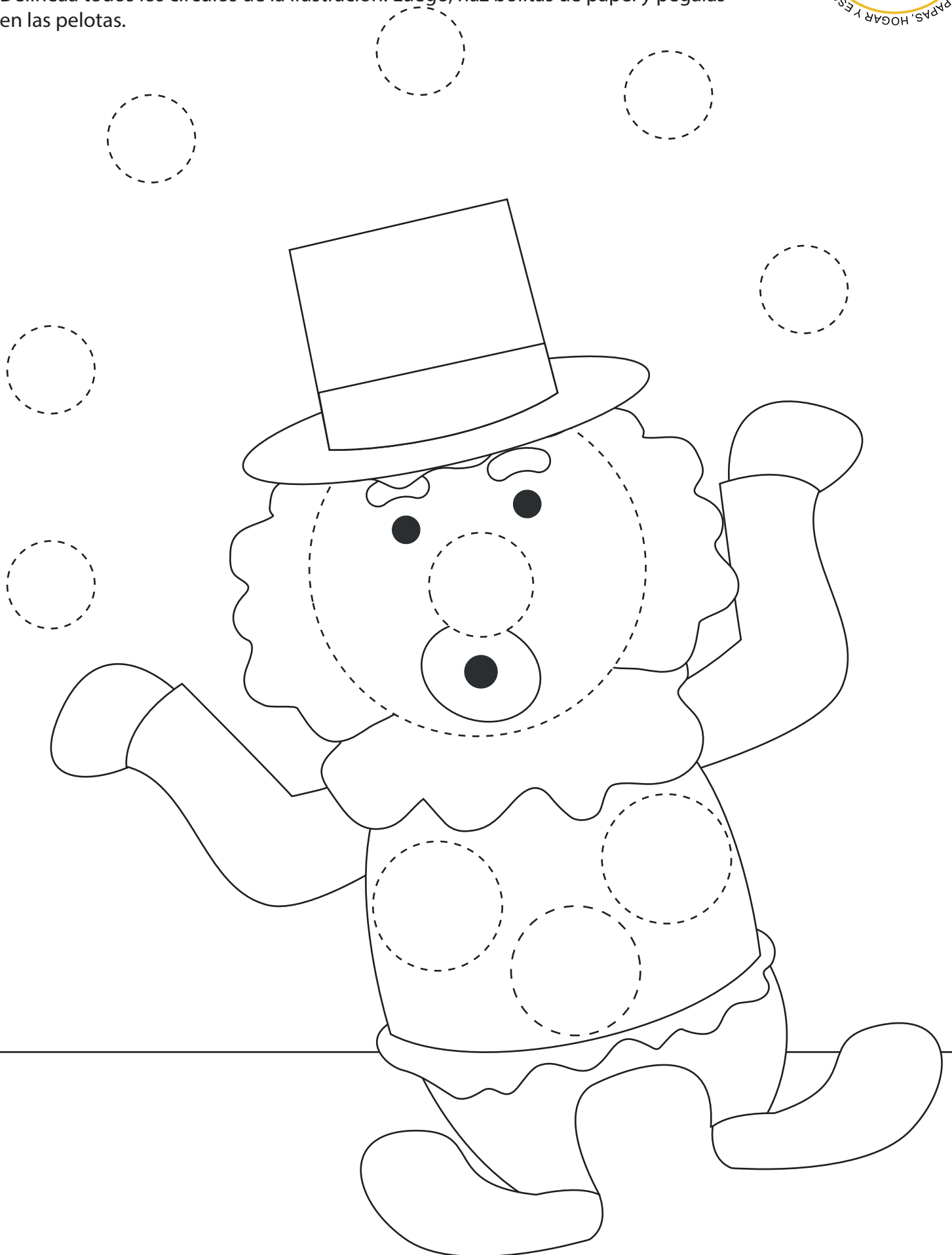



Nombre:

Fecha:

## Actividad 20



### Delineado y trazado circular.

Delinea las conchitas de los caracoles.

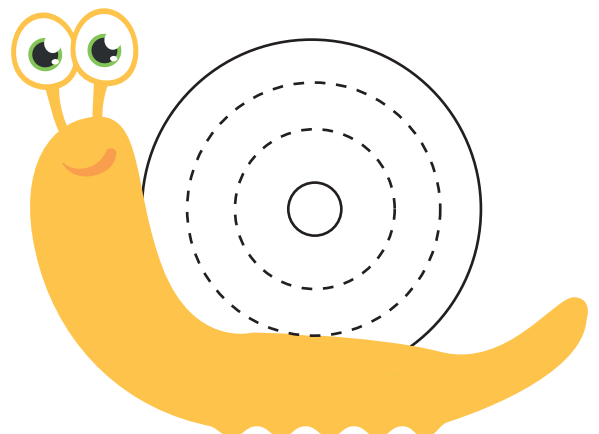
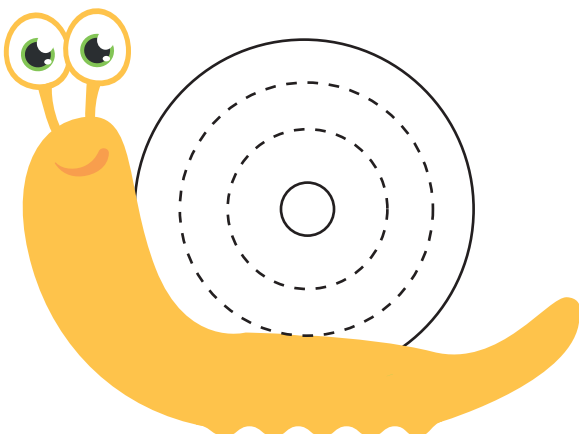
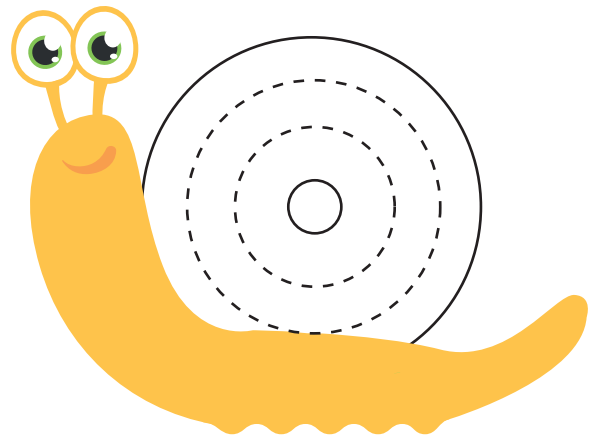
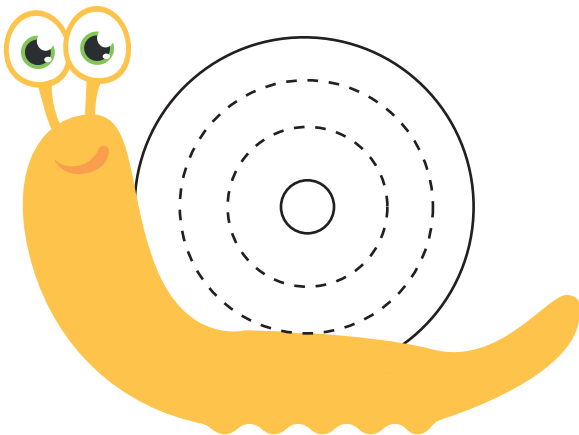
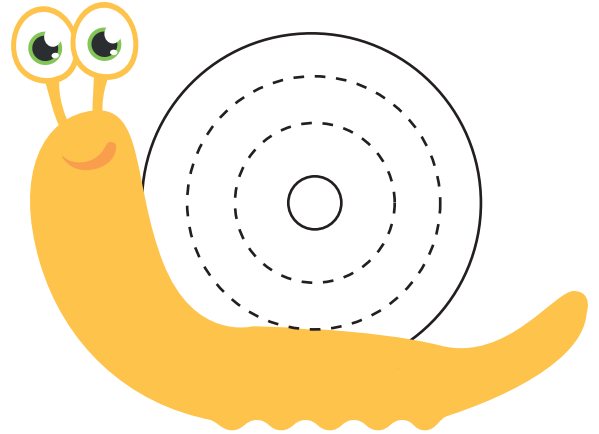
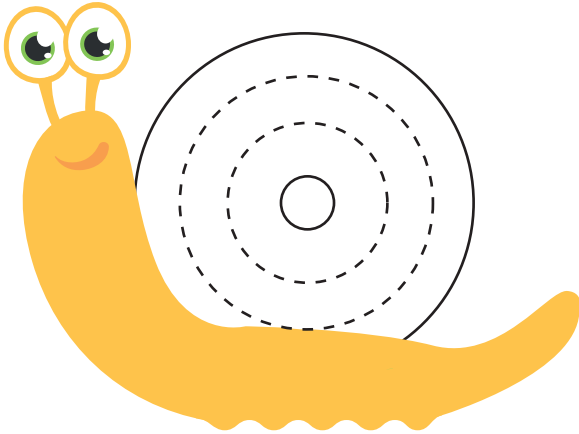

 mundo primaria

# CUADERNO DE VACACIONES

*para Educación Infantil*

**50 FICHAS  
PARA TRABAJAR**

ATENCIÓN  
GRAFOMOTRICIDAD  
LECTURA  
NÚMEROS  
CÁLCULO  
ESCRITURA

[www.mundoprimary.com](http://www.mundoprimary.com)



**4-5  
AÑOS**

FICHAS PARA TRABAJAR  
**GRAFOMOTRICIDAD**

---



Repasa las líneas de puntos.

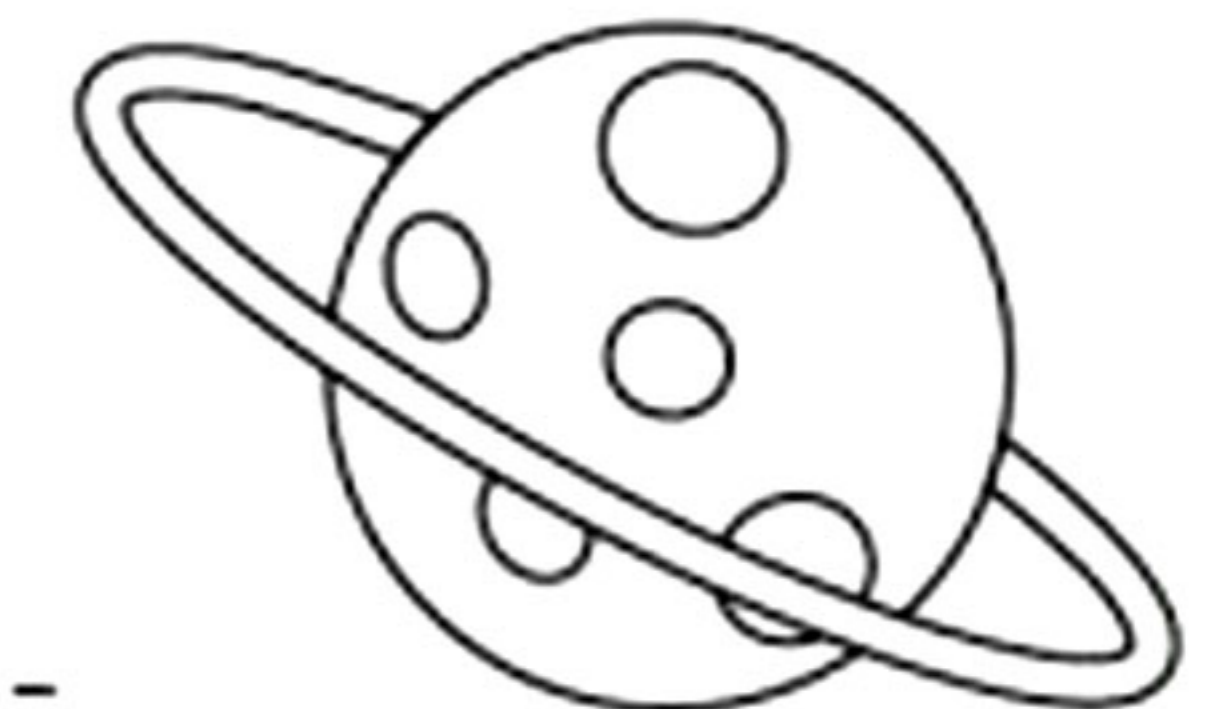
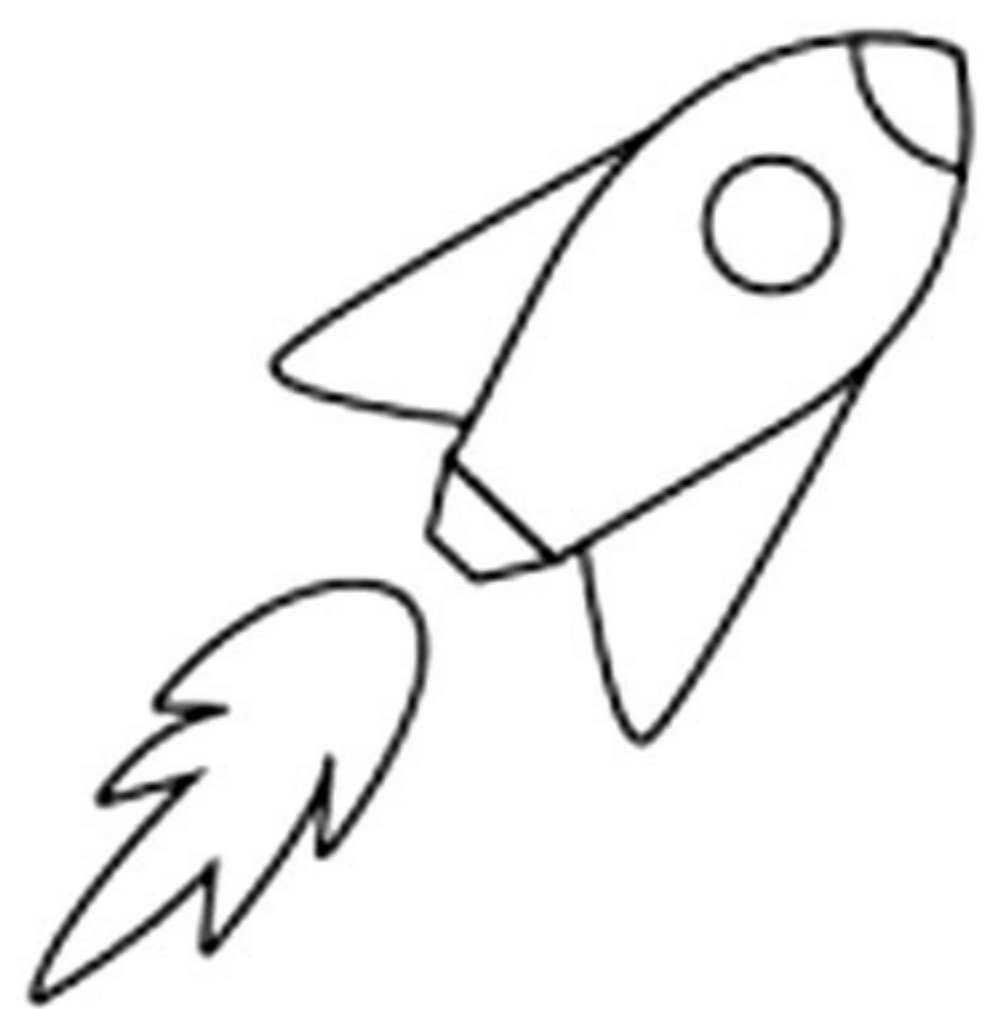
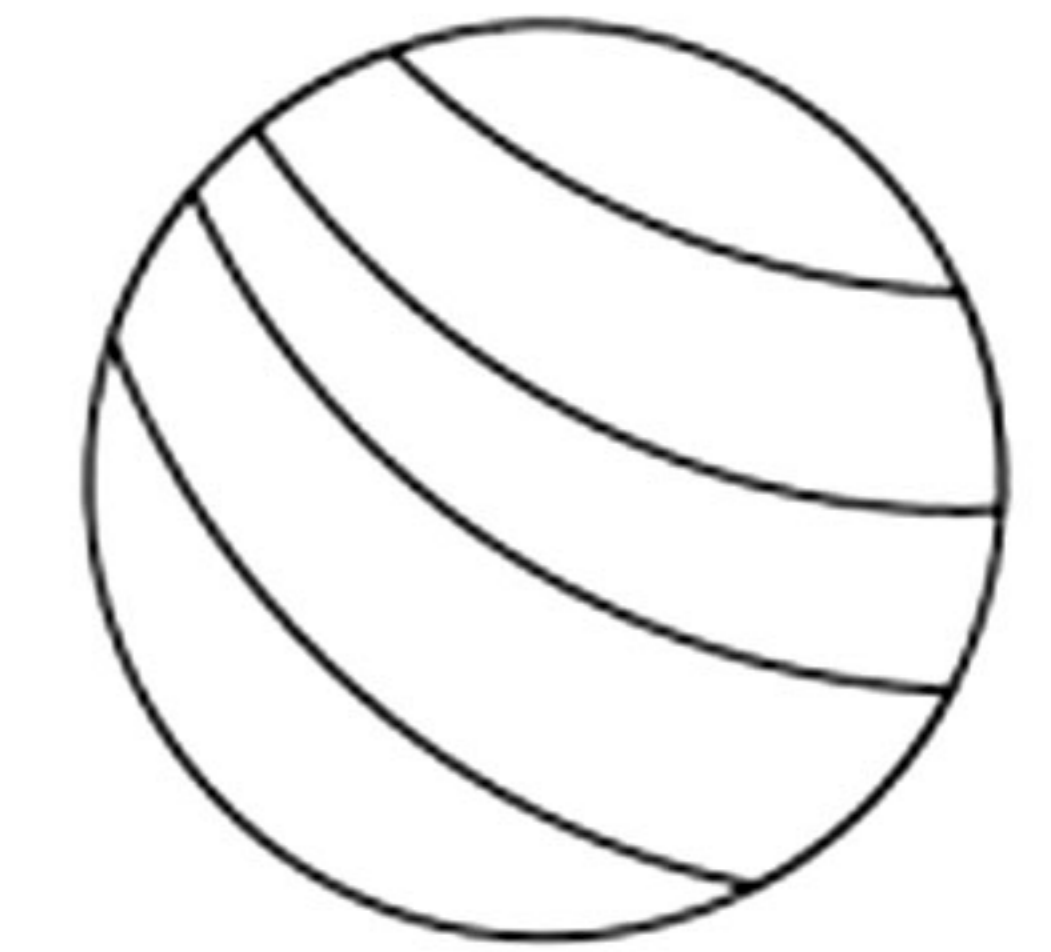
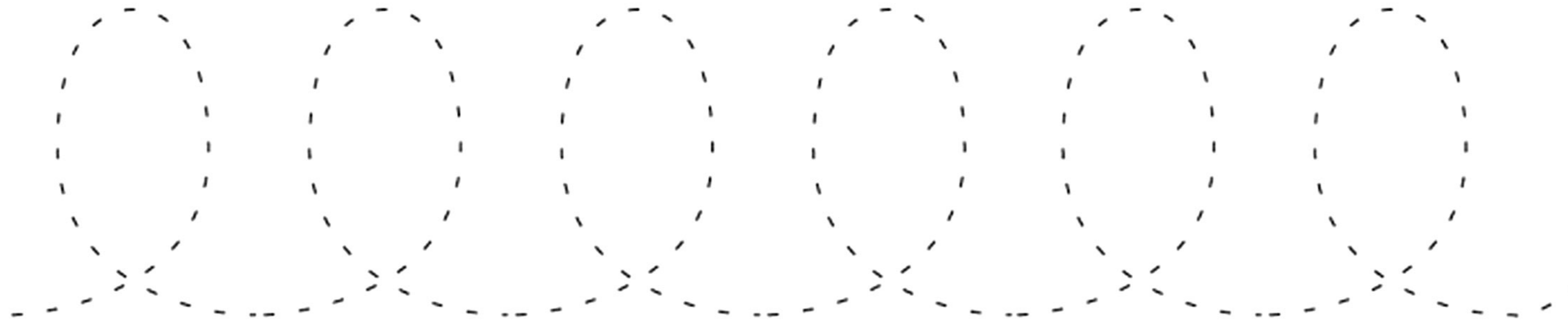



Completa los laberintos para unir los dibujos.

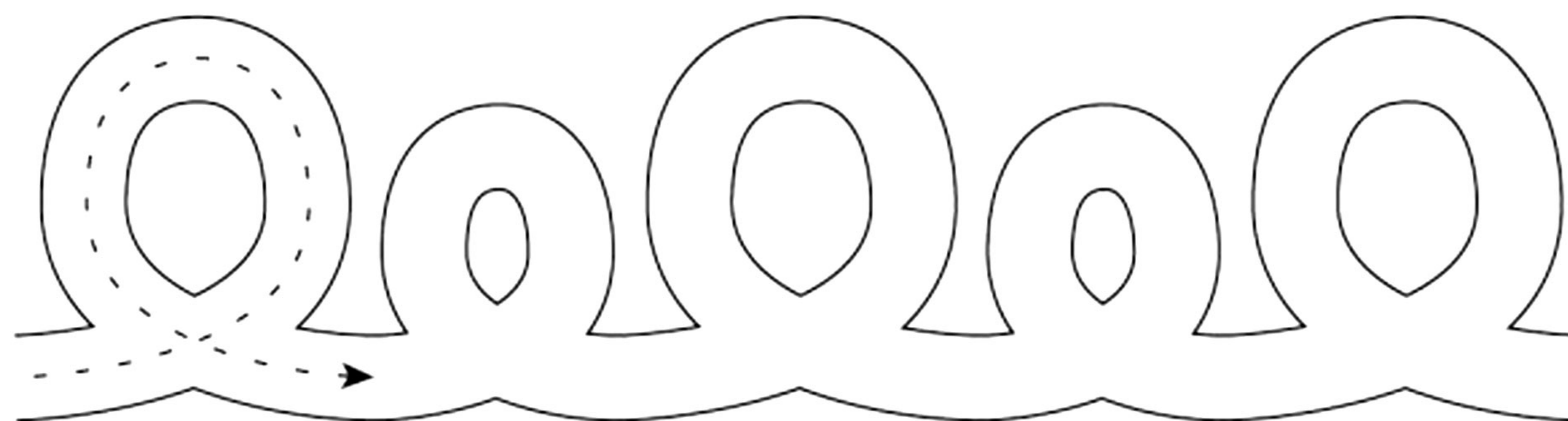
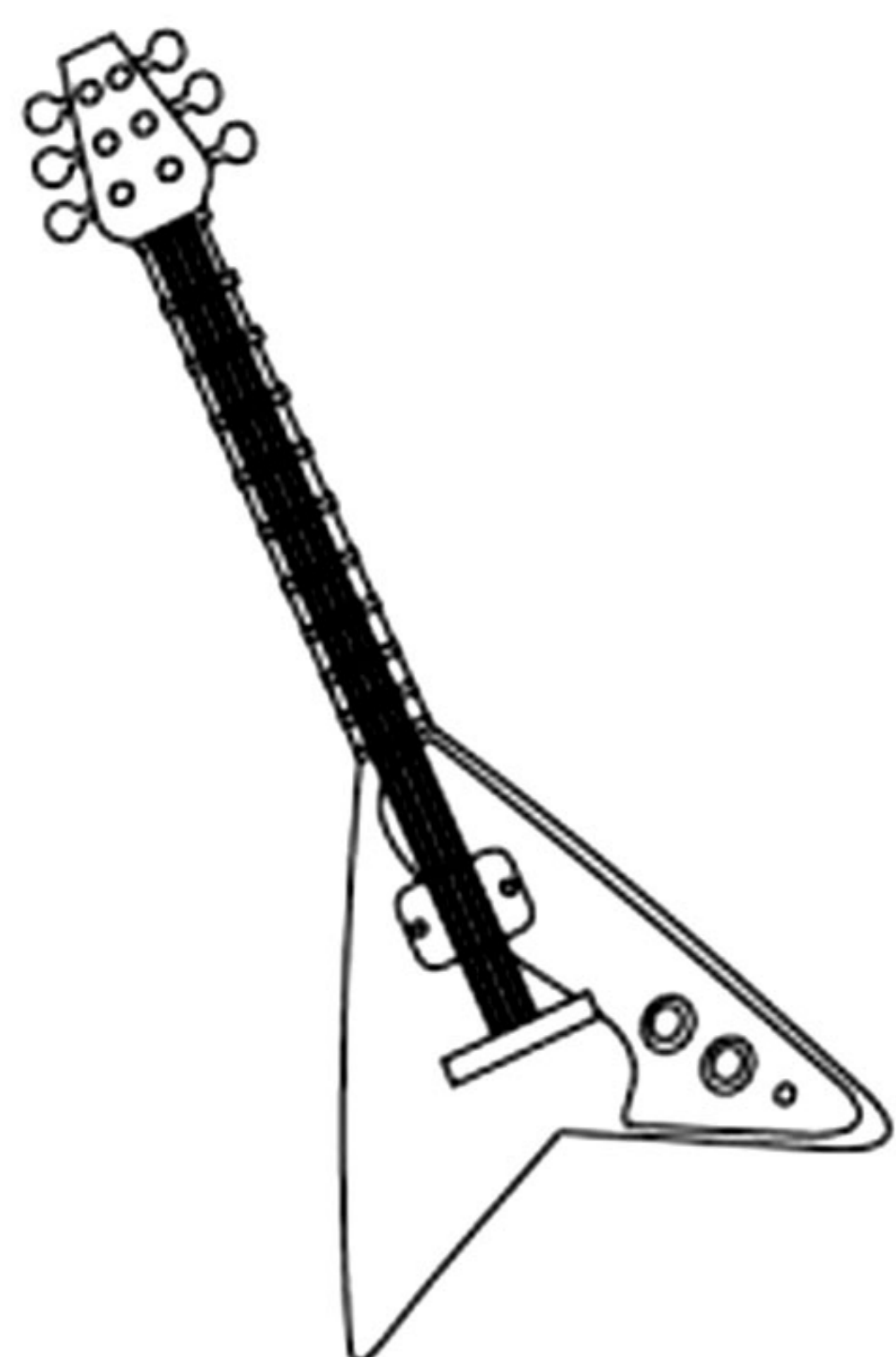
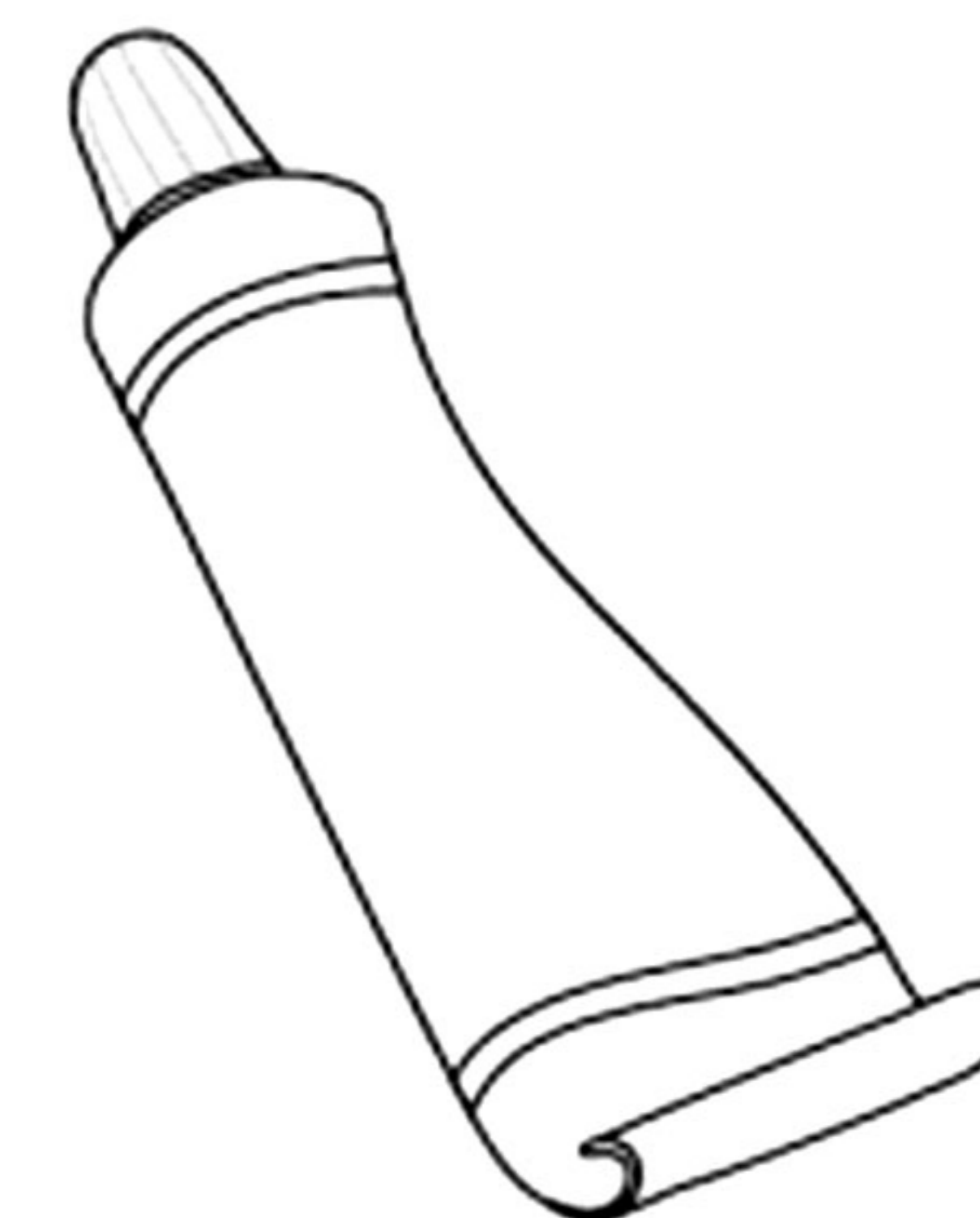
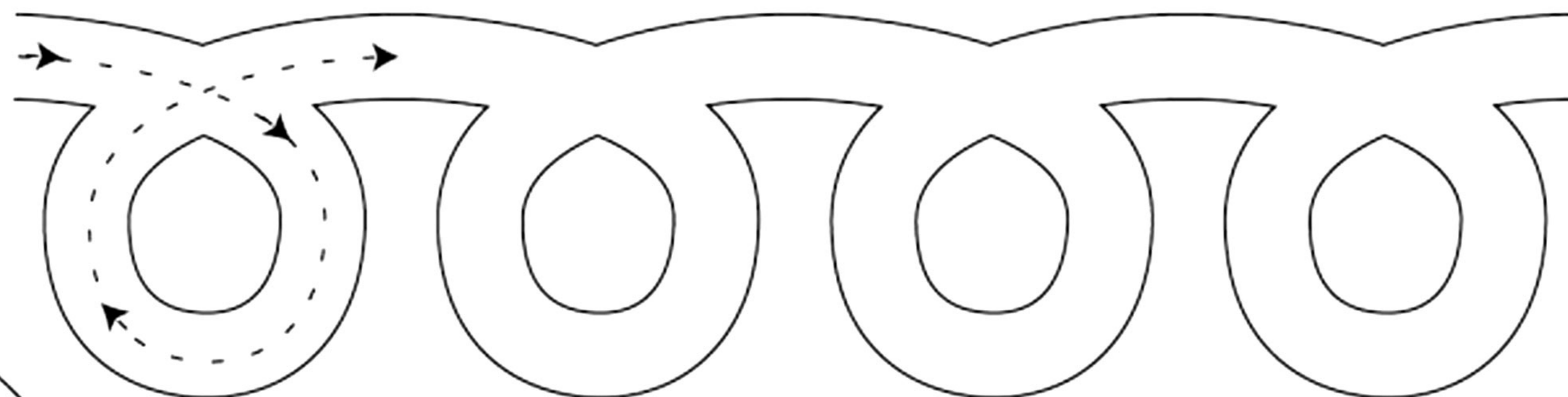
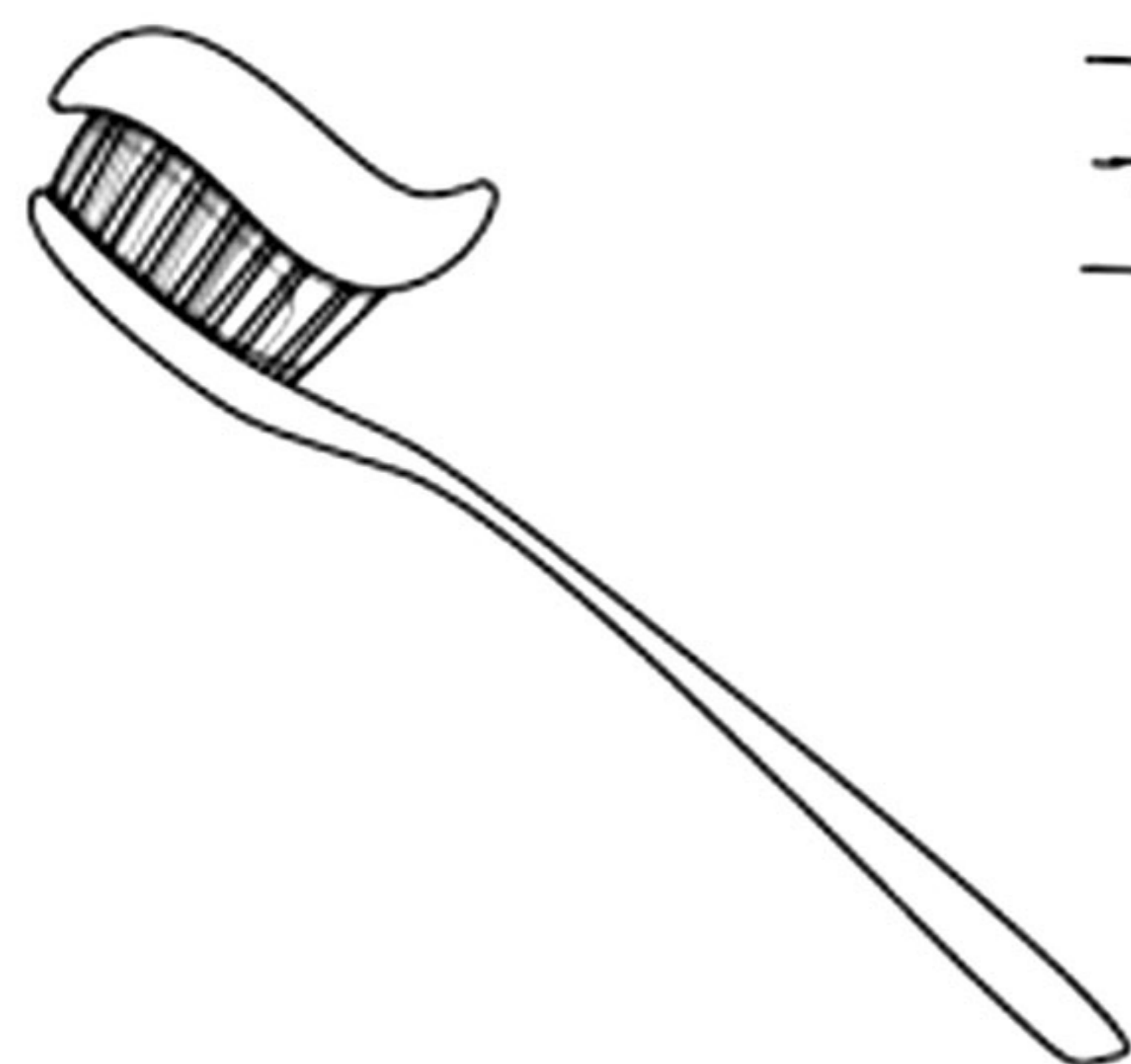

Completa el laberinto para que Papá Noel llegue a su gorro.

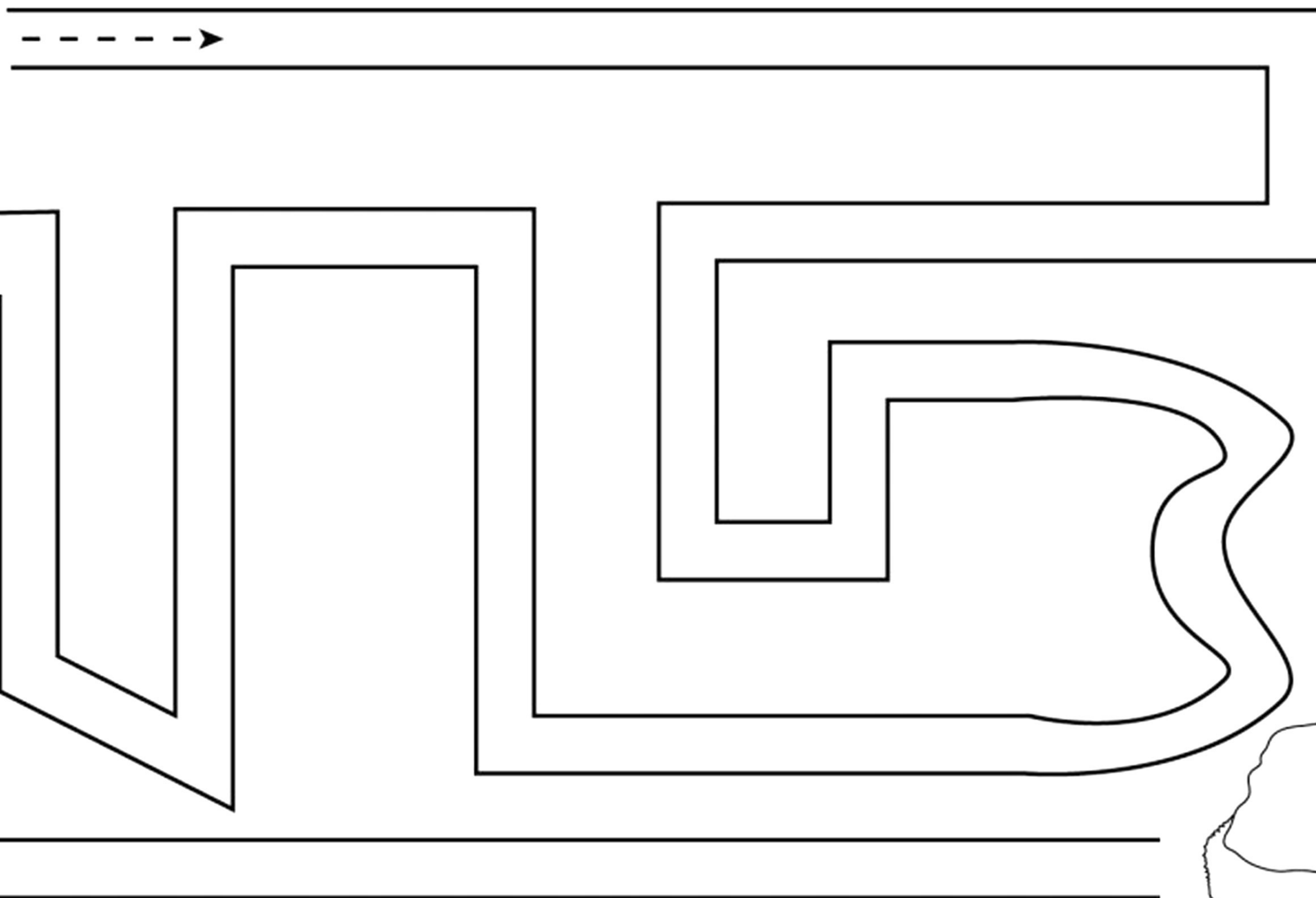

Repasa las líneas de puntos para terminar de dibujar las hélices de los aviones.

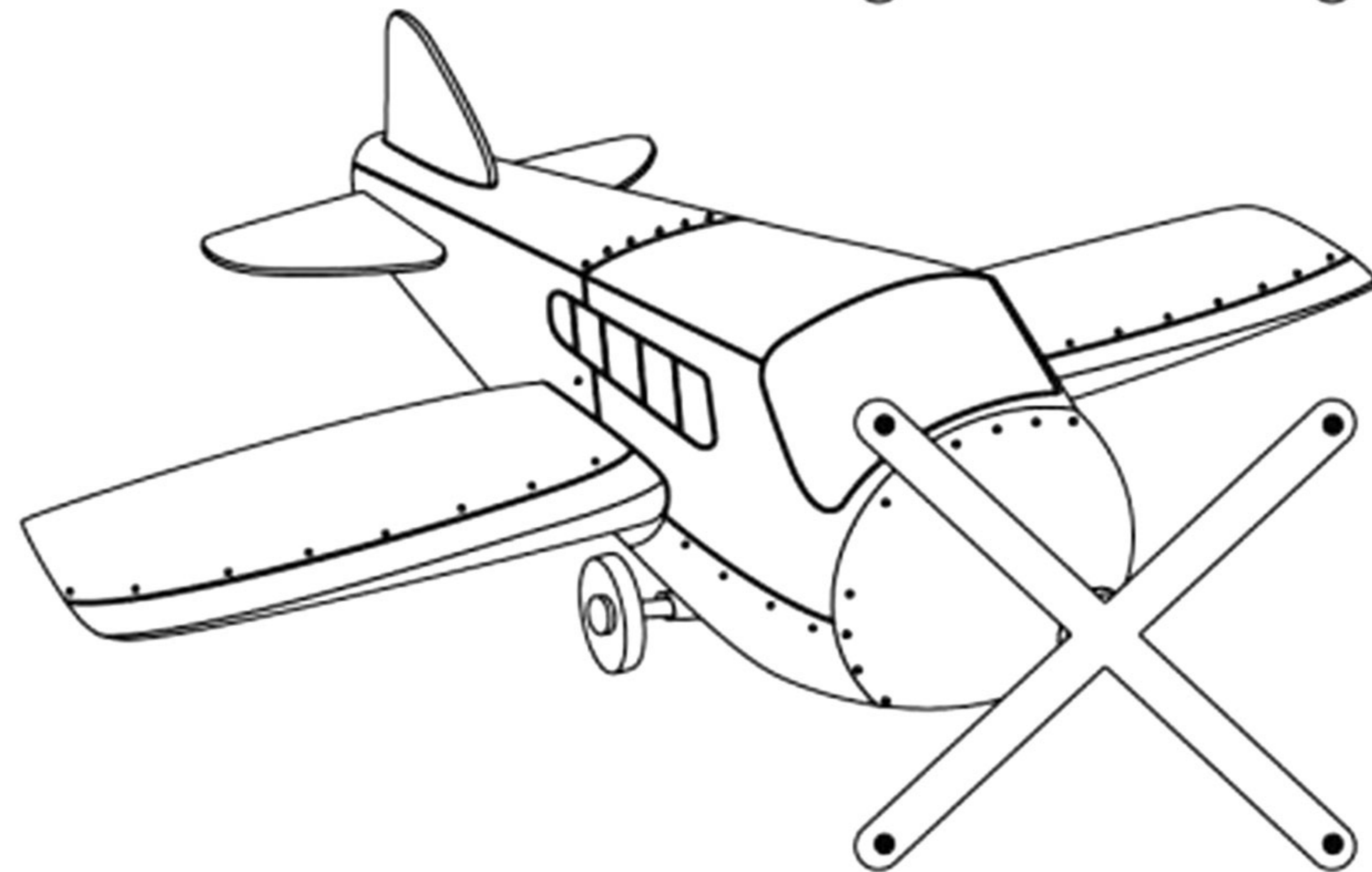
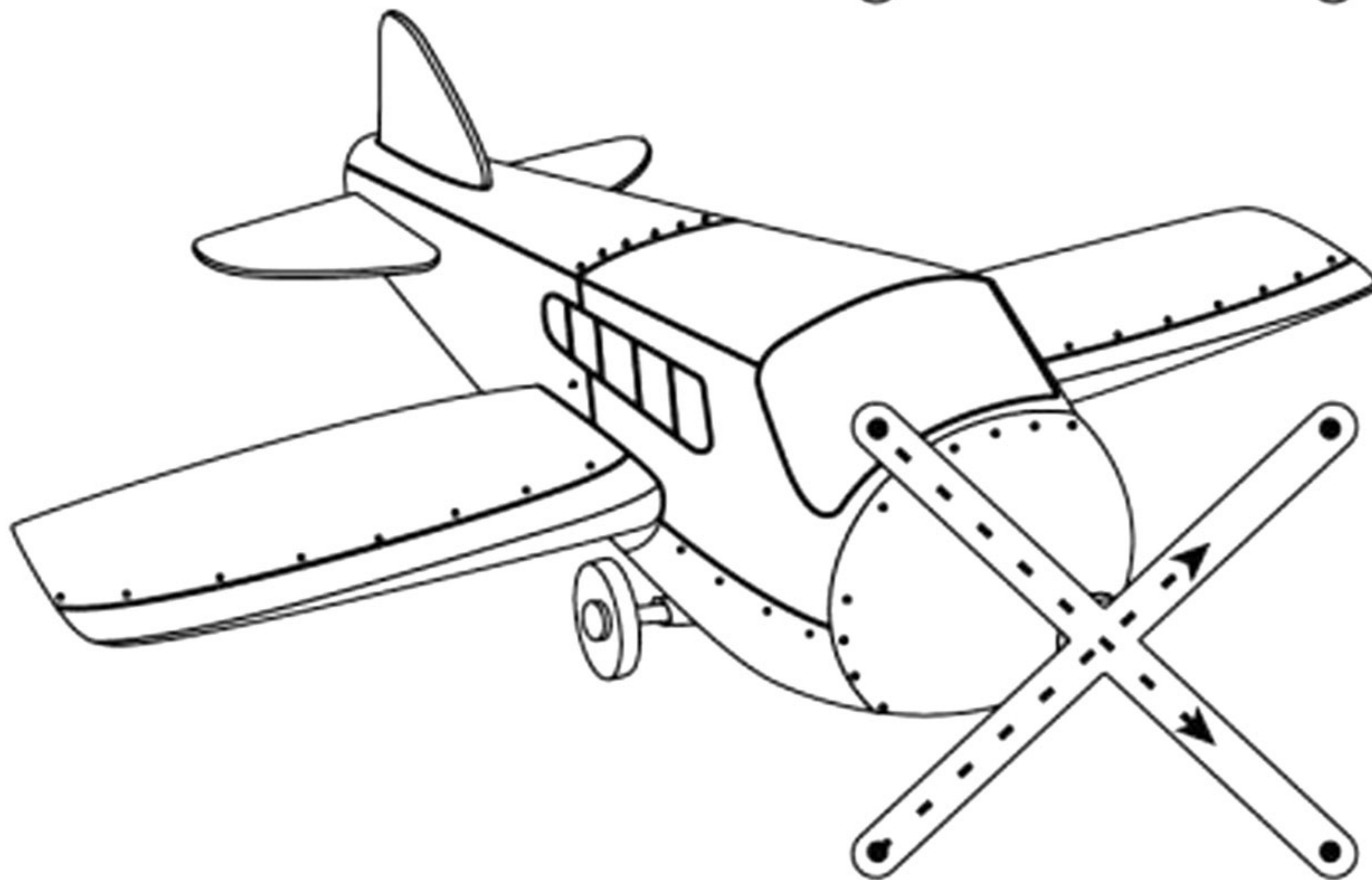
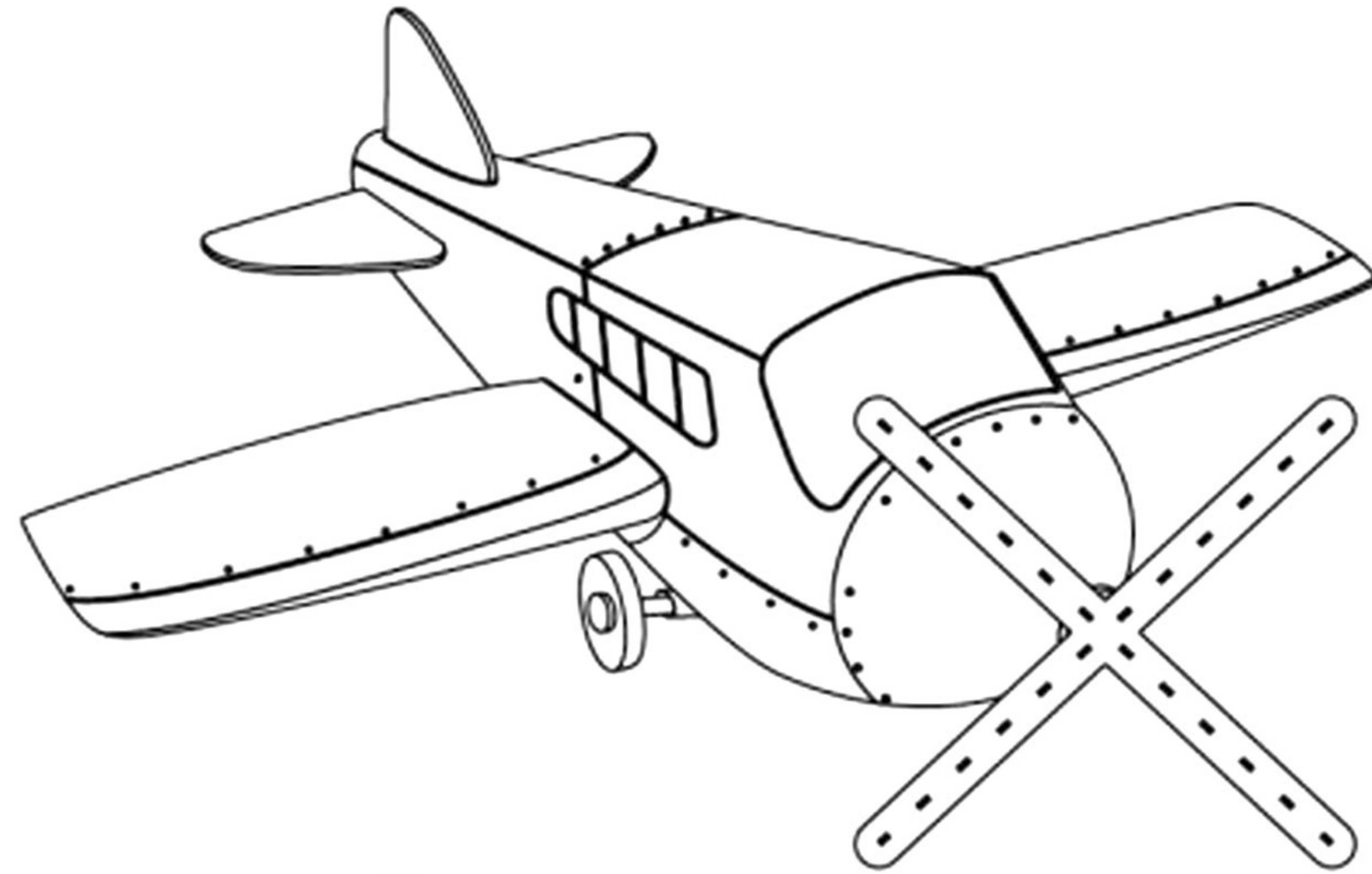
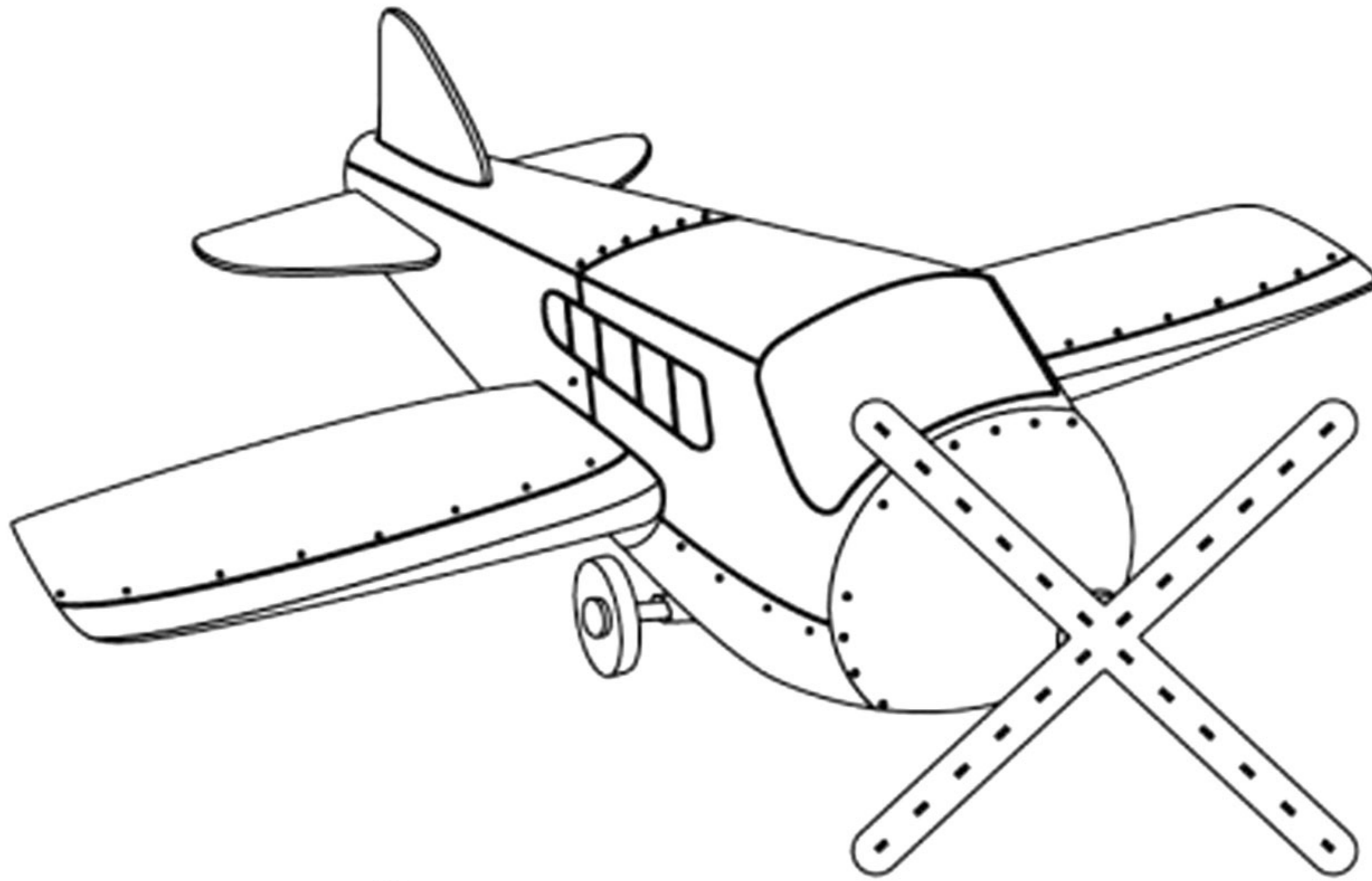



Repasa las líneas de puntos para terminar de dibujar las coronas.

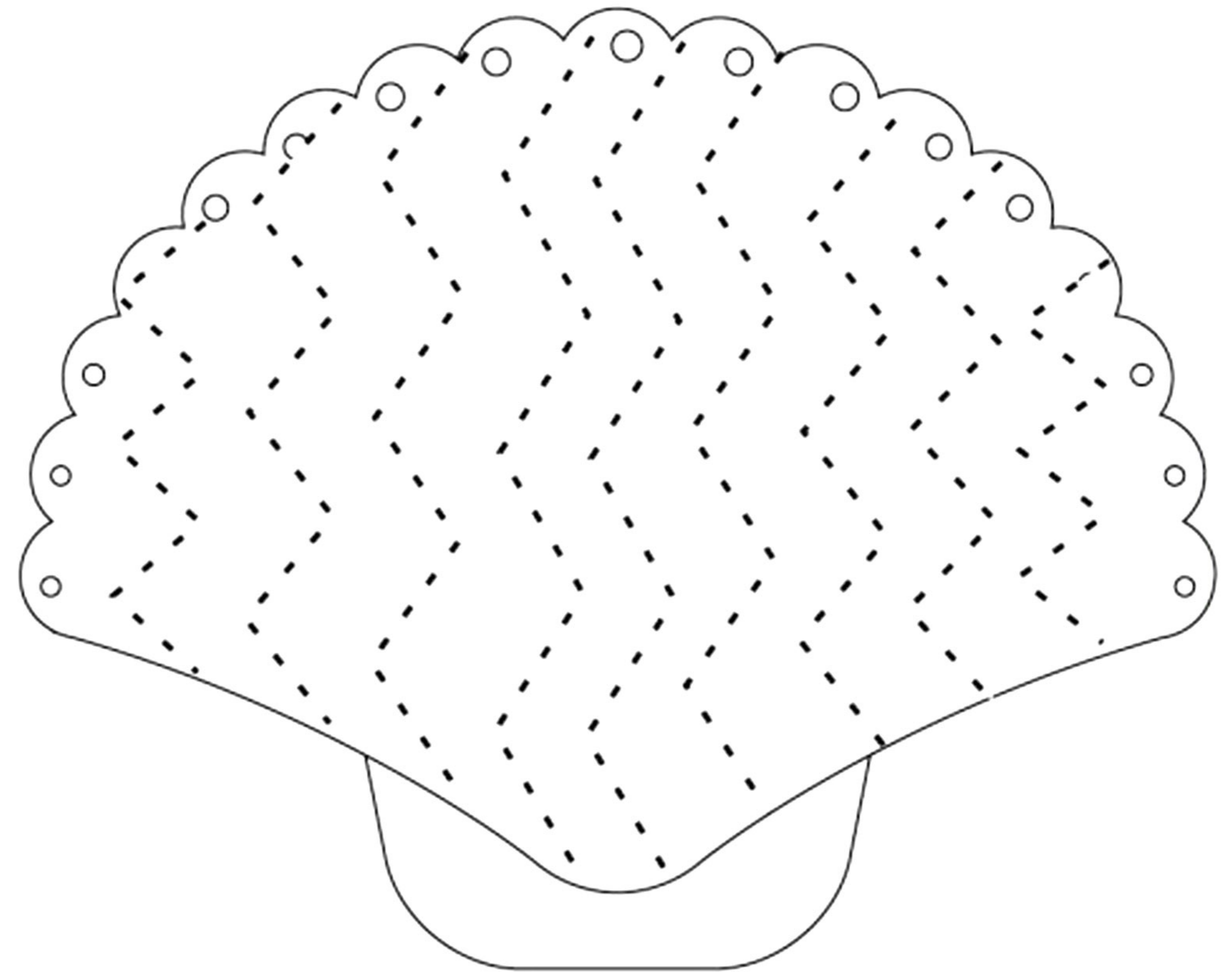
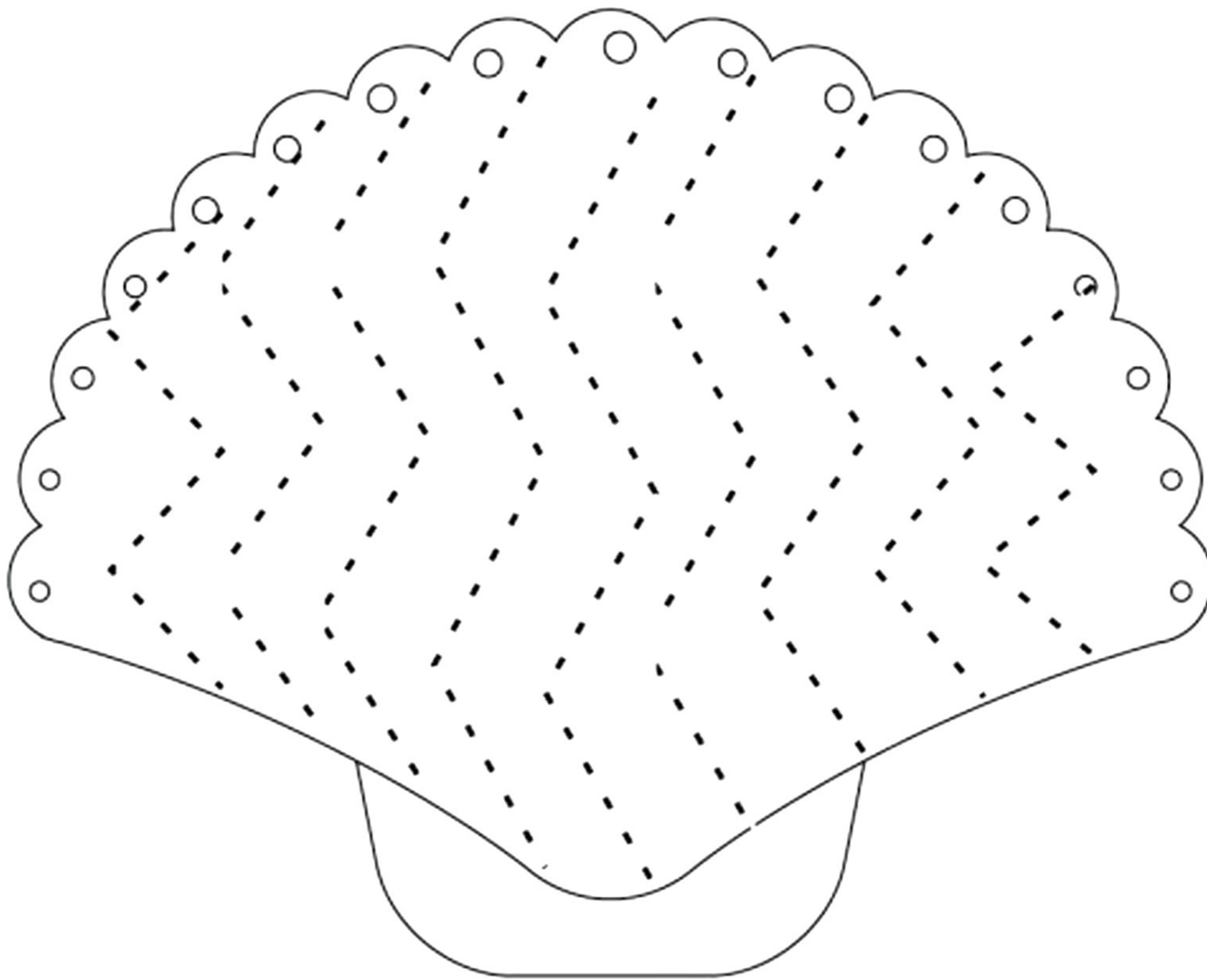

Repasa las líneas de puntos para terminar de dibujar las burbujas del pez.

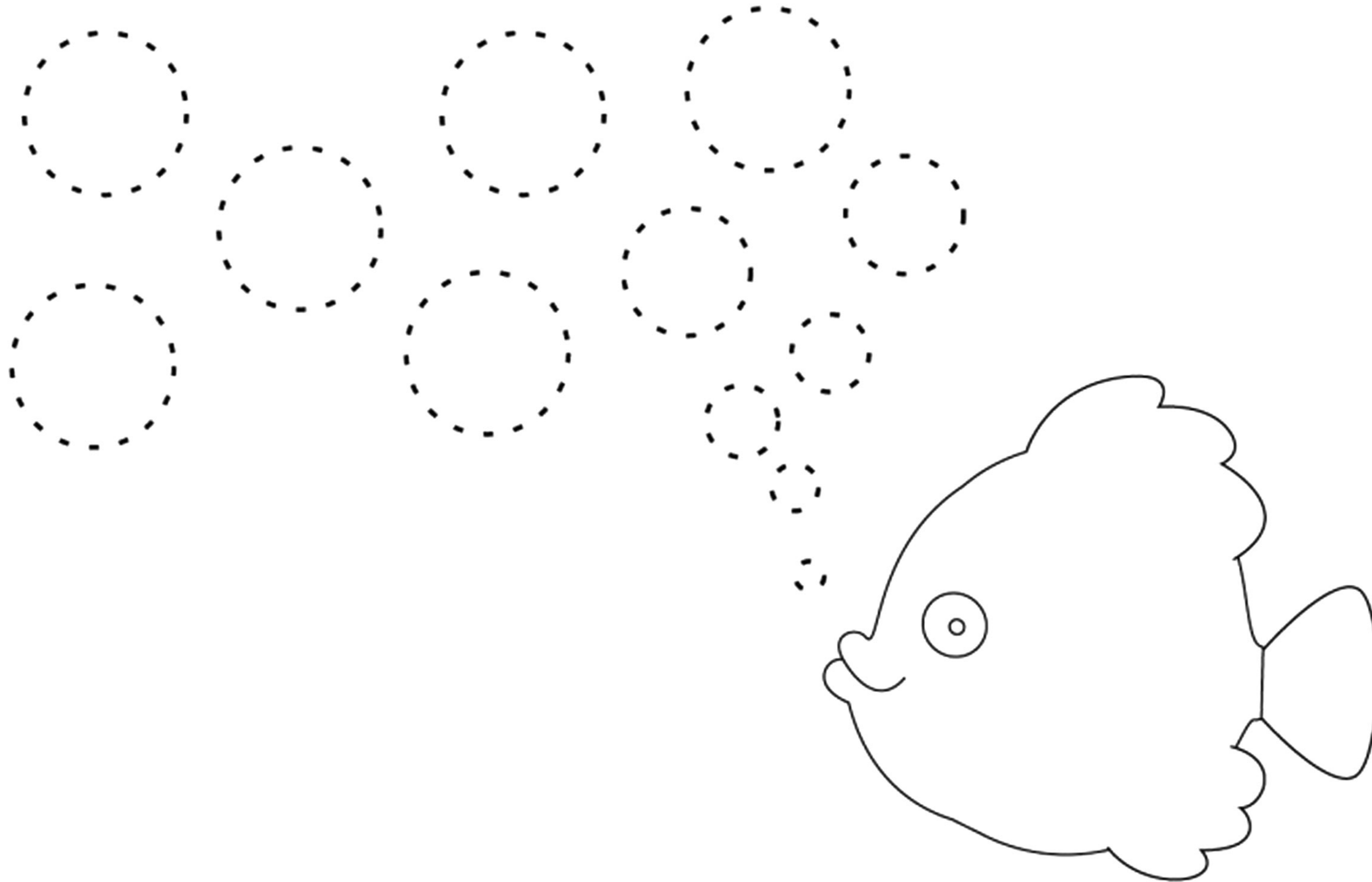

Repasa las líneas de puntos para terminar de dibujar los alimentos.

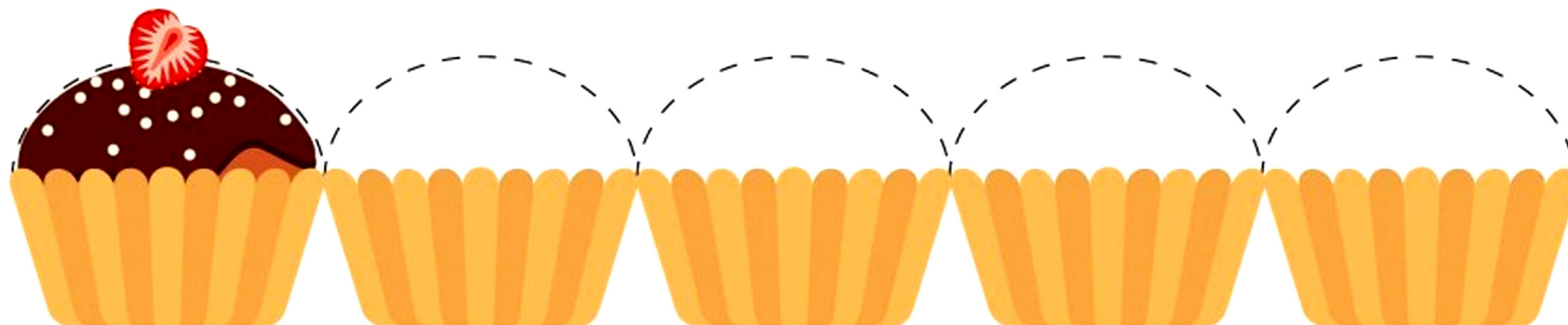
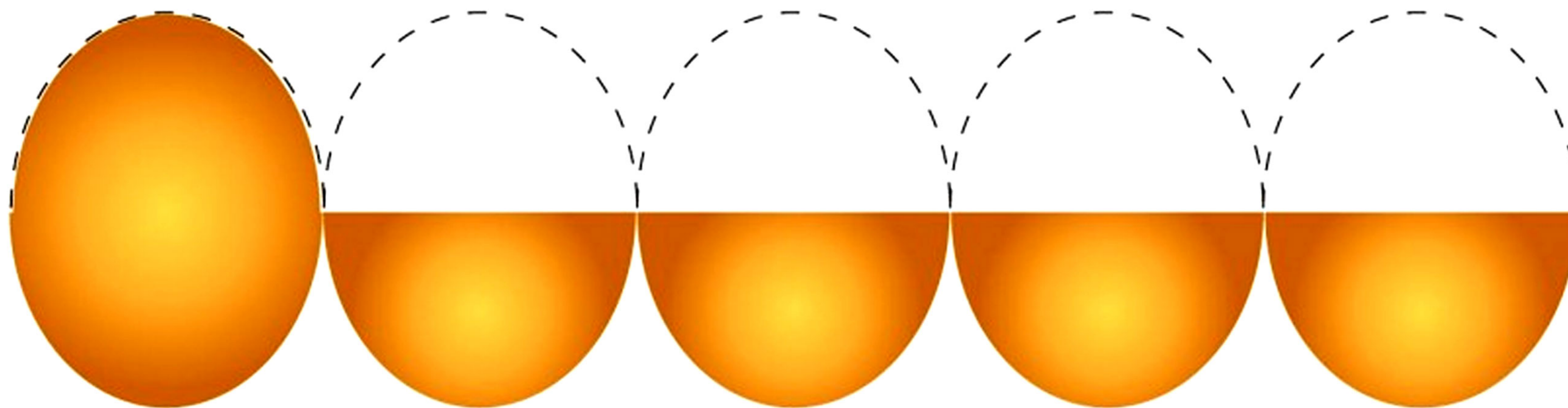

Repasa las líneas de puntos para terminar de dibujar los objetos.

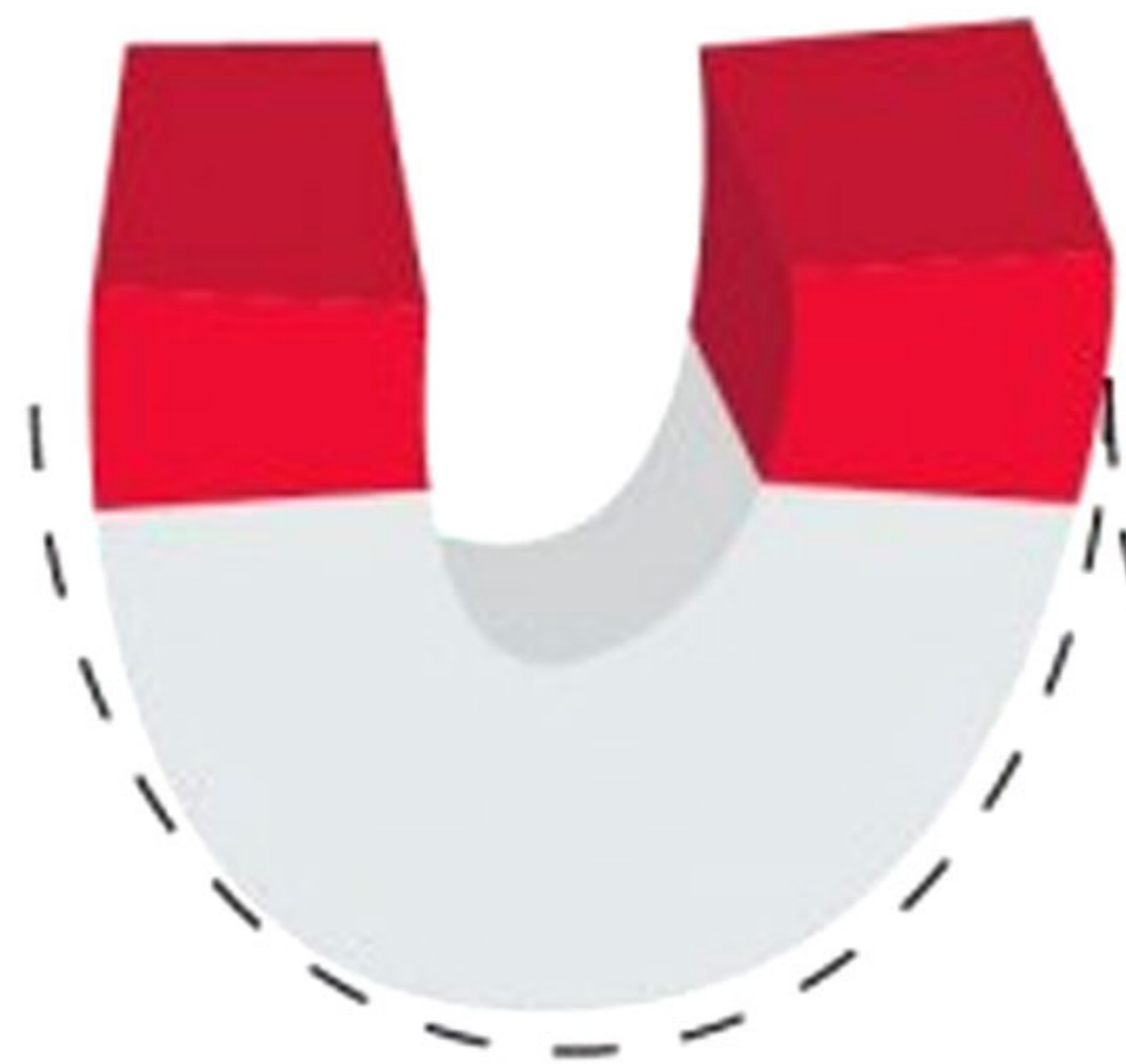

Repasa las líneas de puntos y completa la ropa de estos niños.

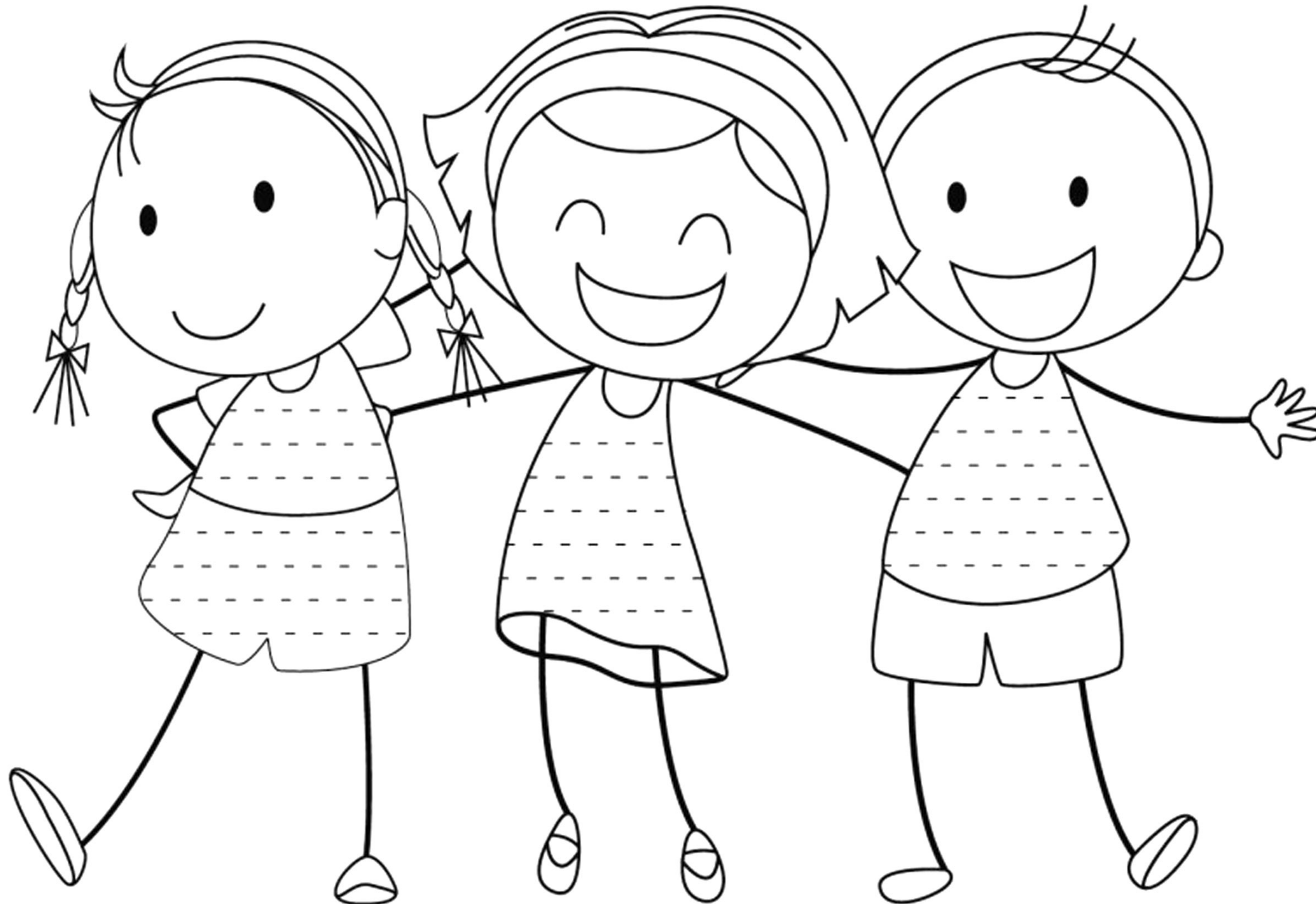

Repasa las líneas de puntos y completa el cuerpo de estos insectos.

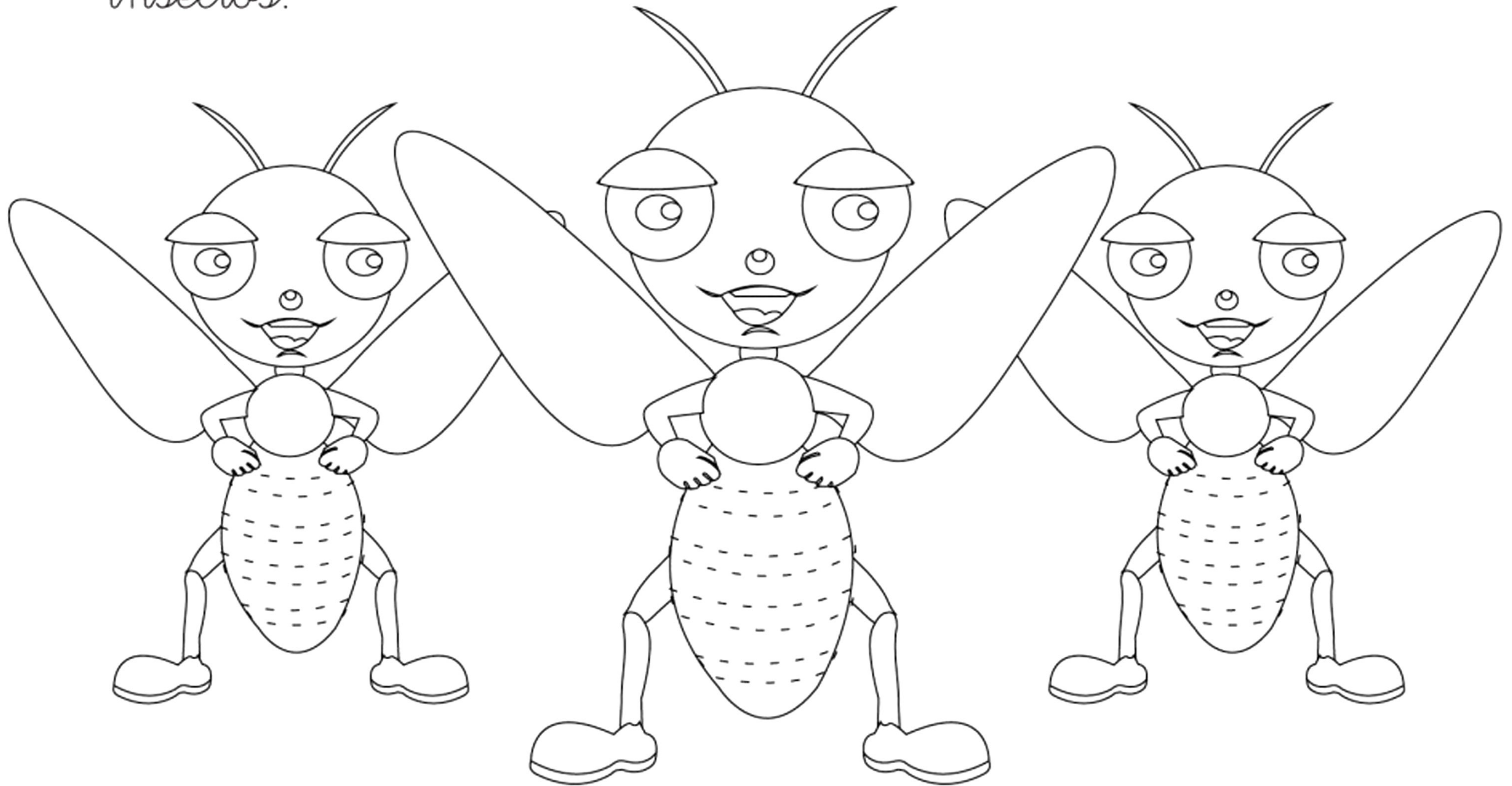

Completa los laberintos para unir los dibujos.

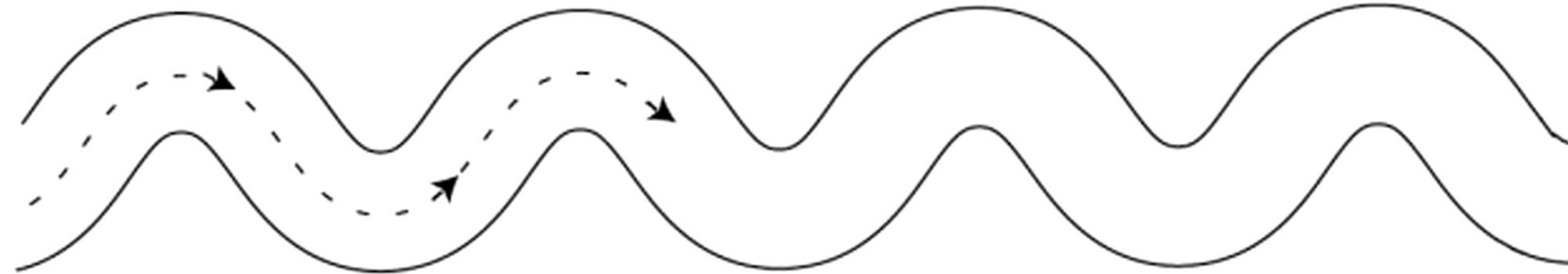
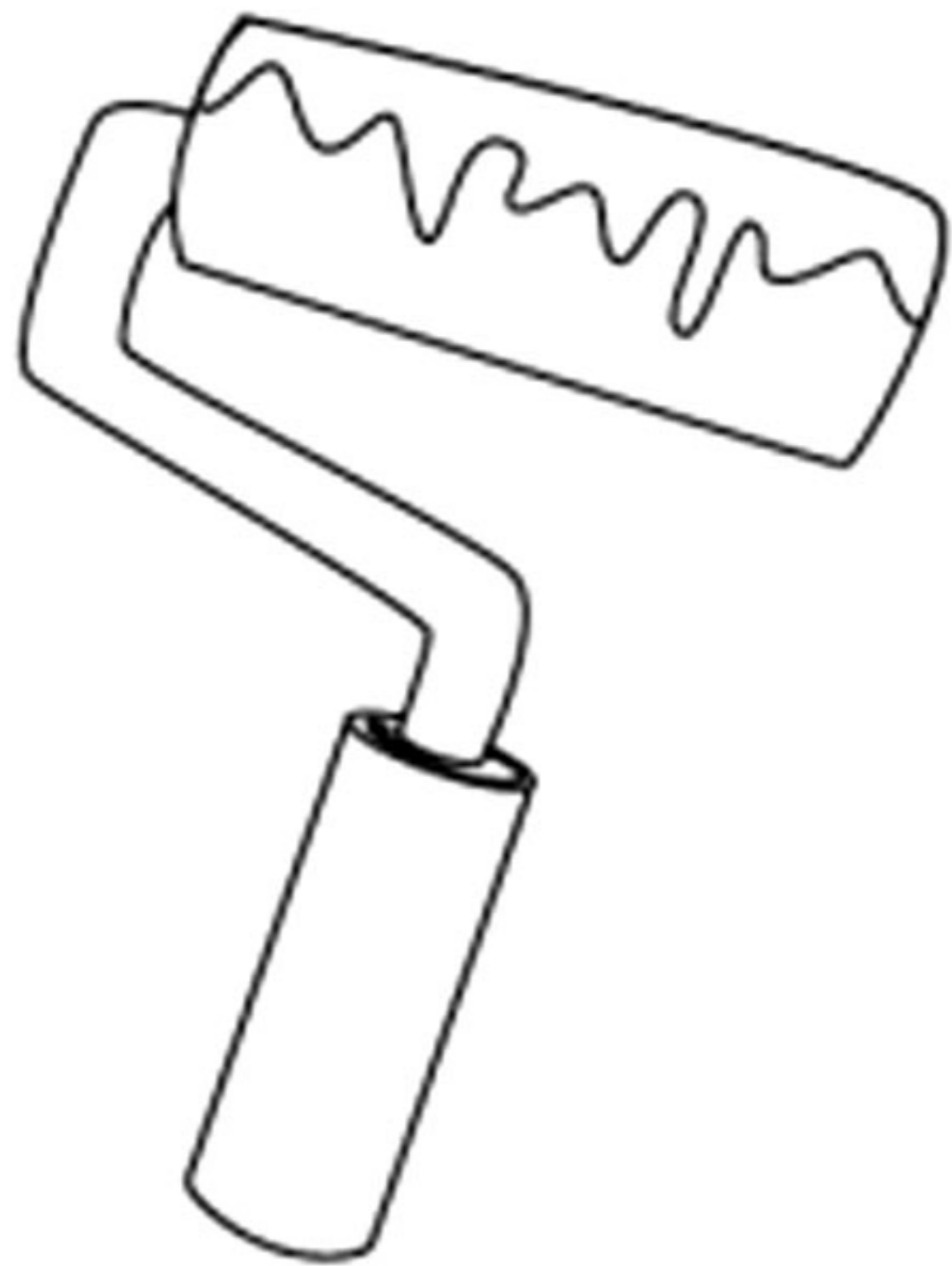

Completa el laberinto para que la mariposa llegue a las flores.

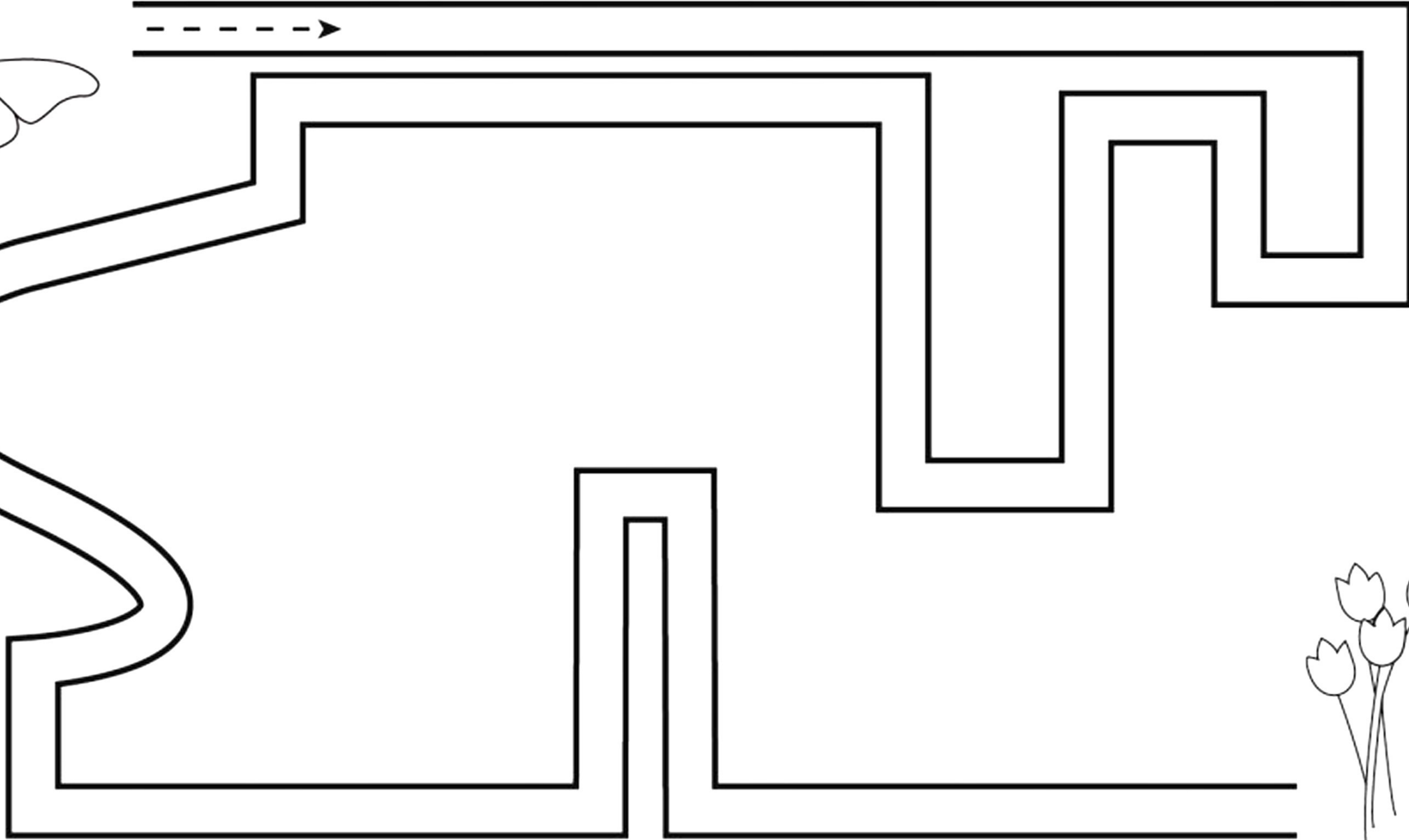
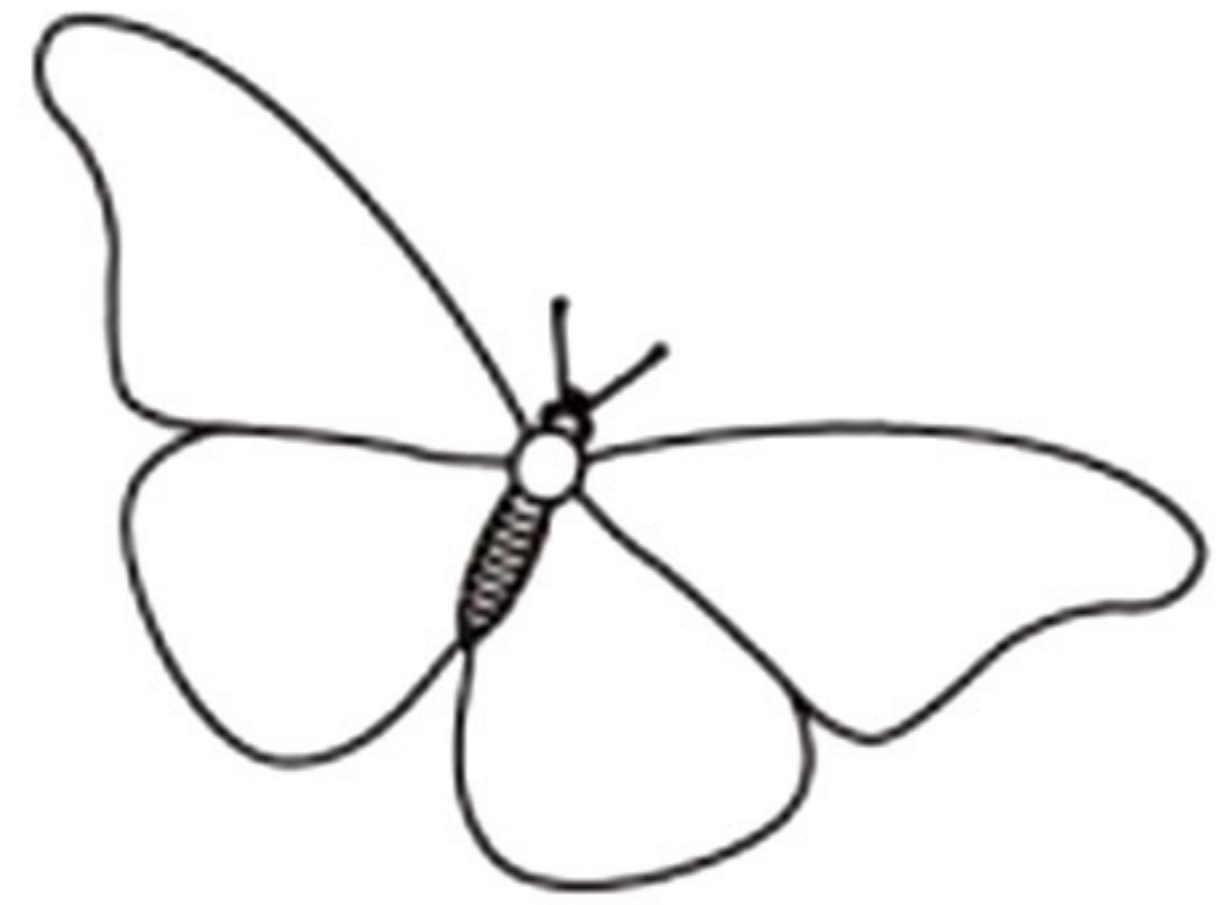



Repasa las líneas de puntos para terminar de dibujar las coronas.

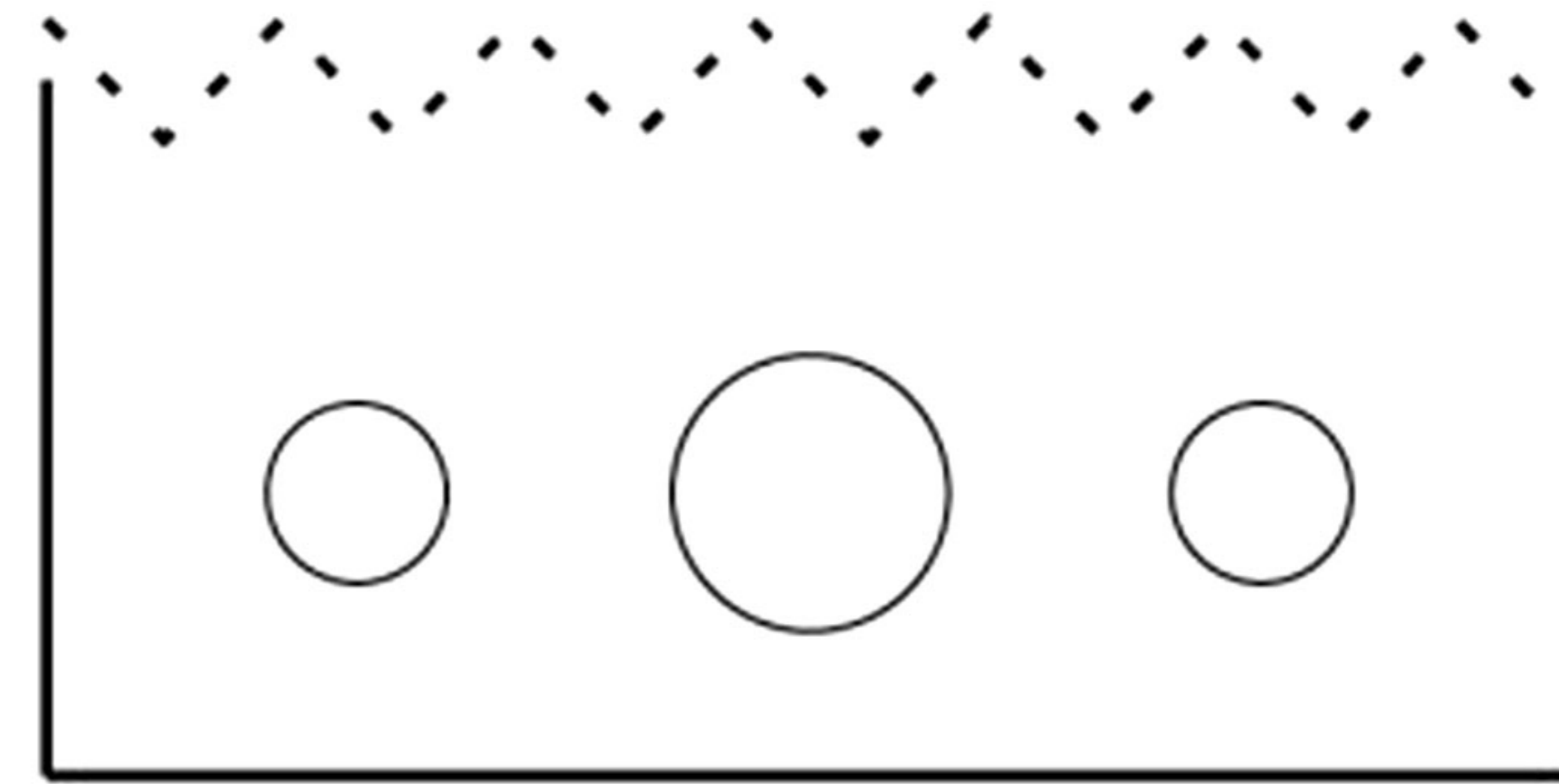
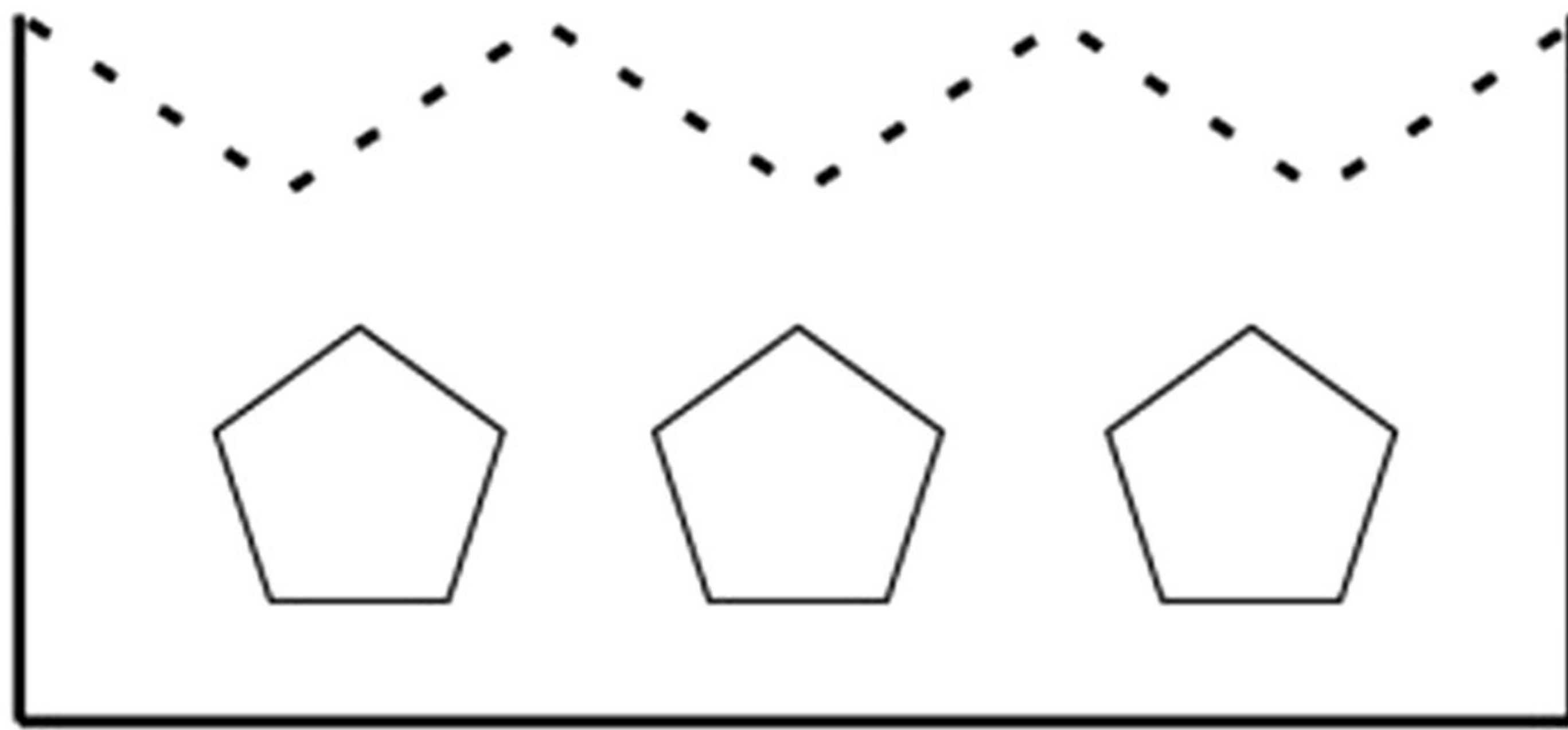

Repasa las líneas de puntos y completa la caja de  
ceras de colores.

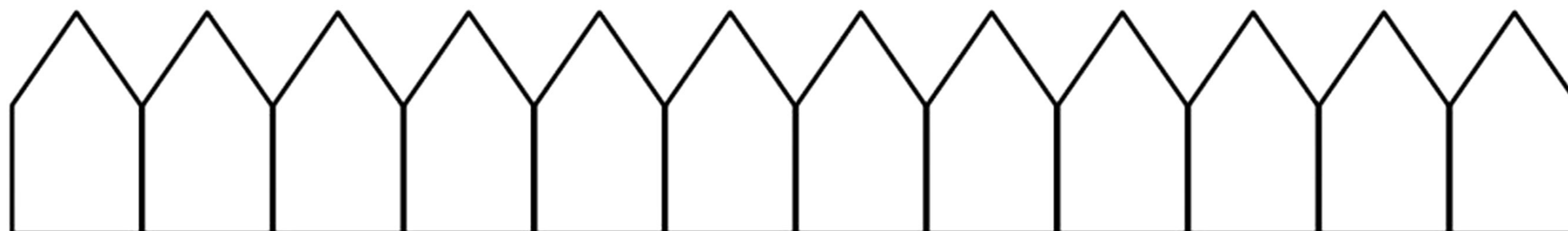

colores

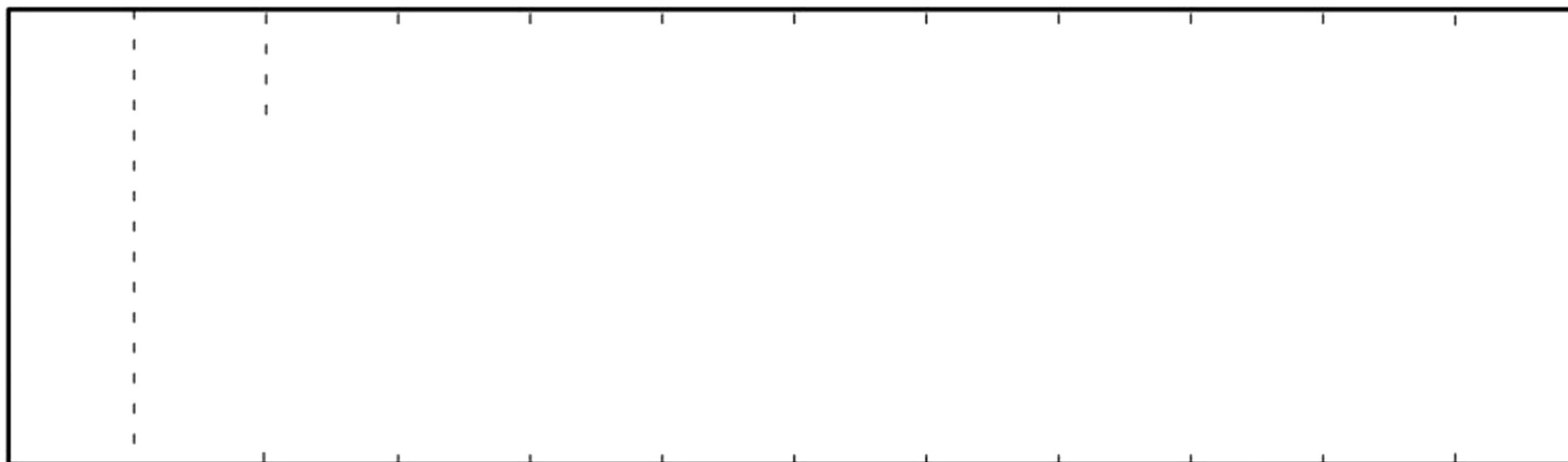

FICHAS PARA TRABAJAR LA

# **ATENCIÓN**

---



Rodea los objetos que sean iguales  
a los modelos

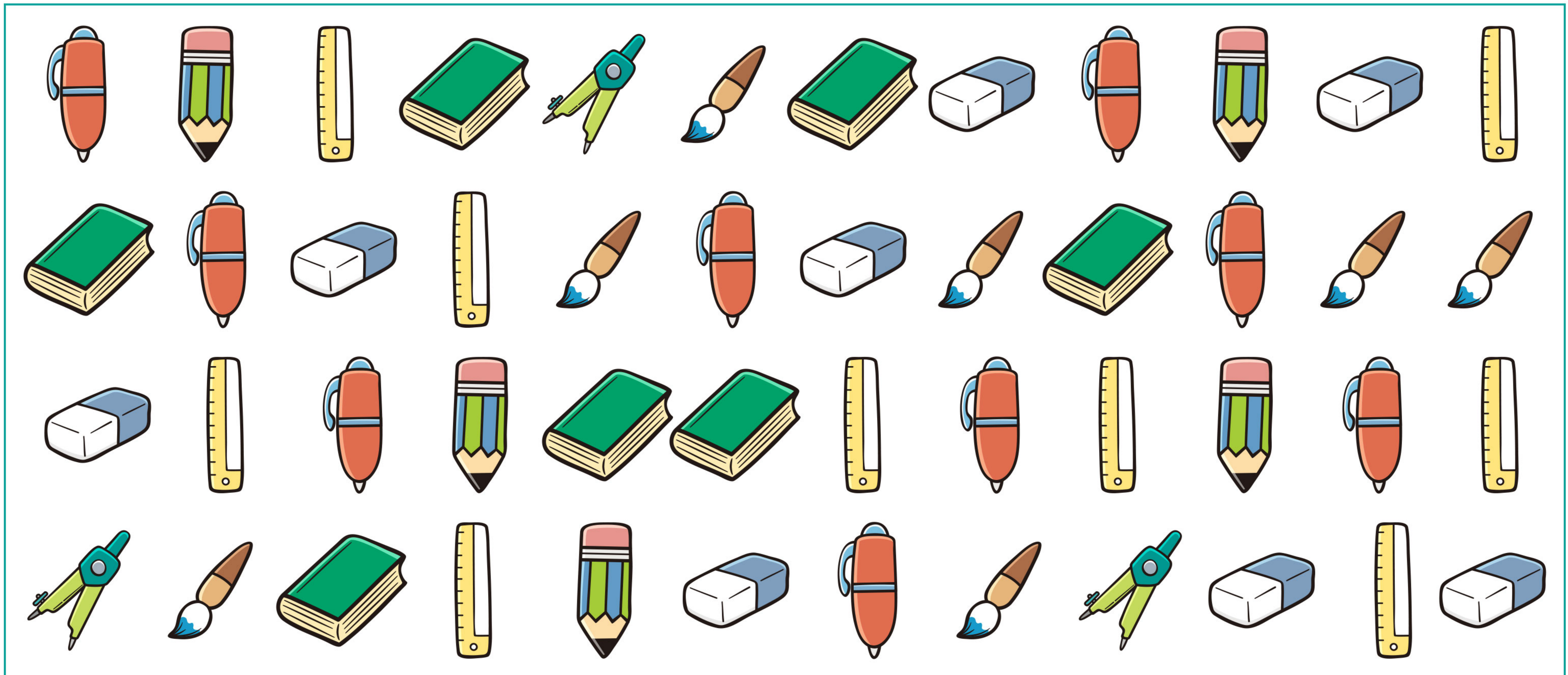

Une los objetos siguiendo el orden marcado

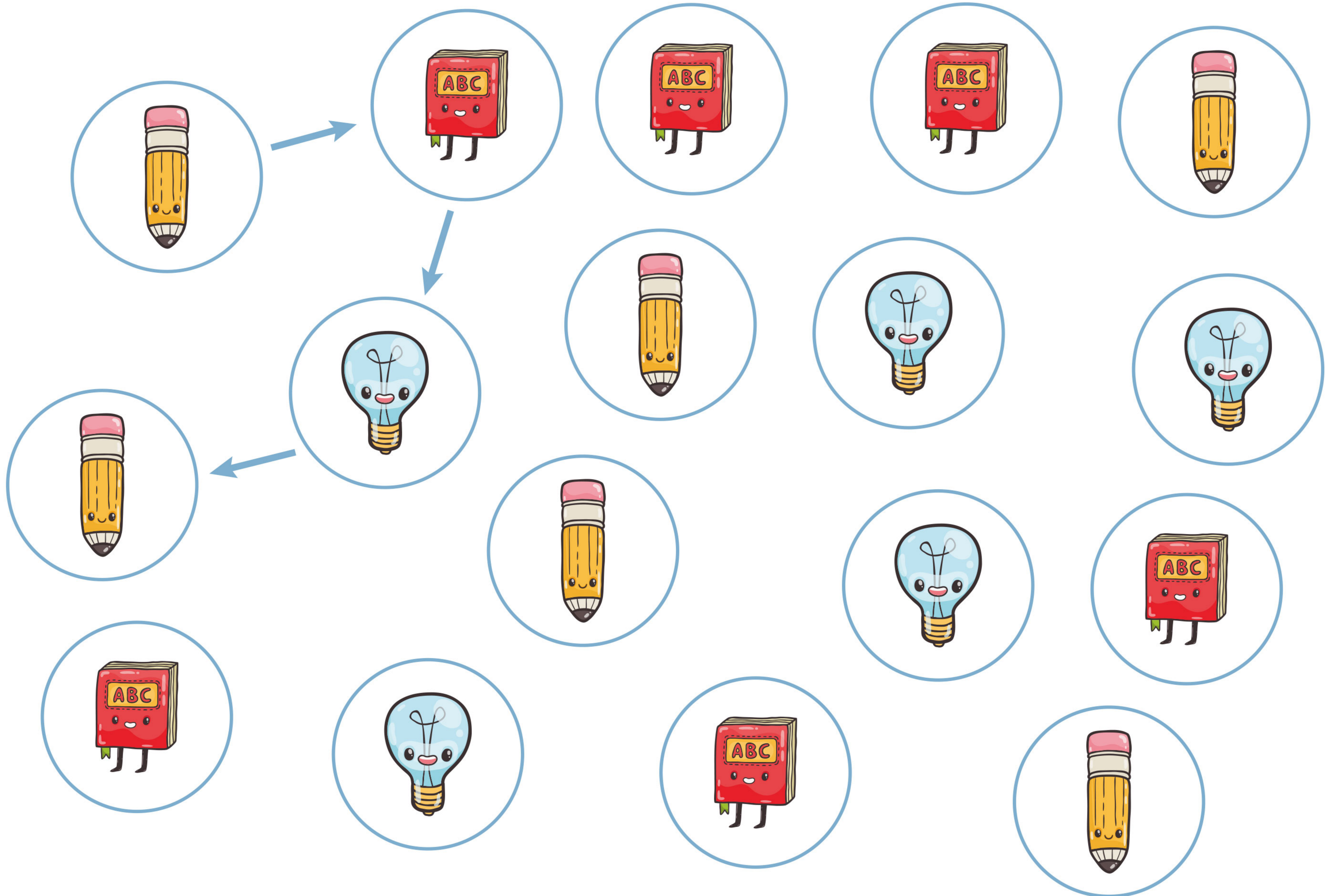

Completa los dibujos con los símbolos que les corresponden

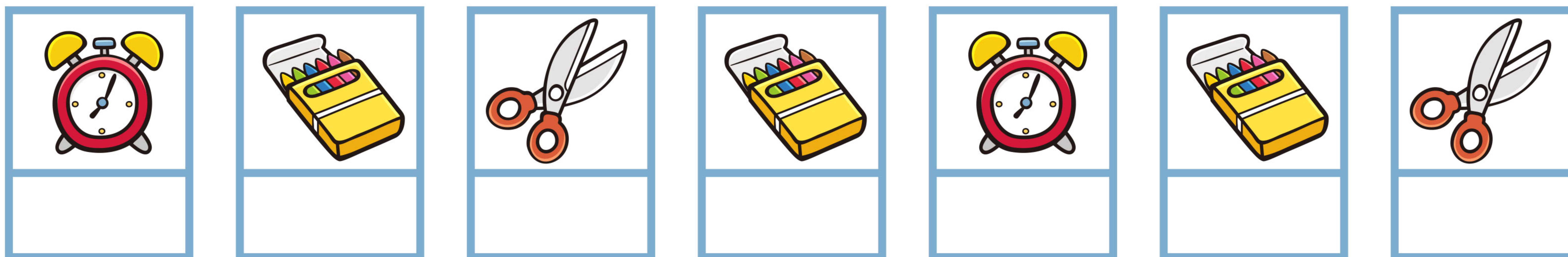
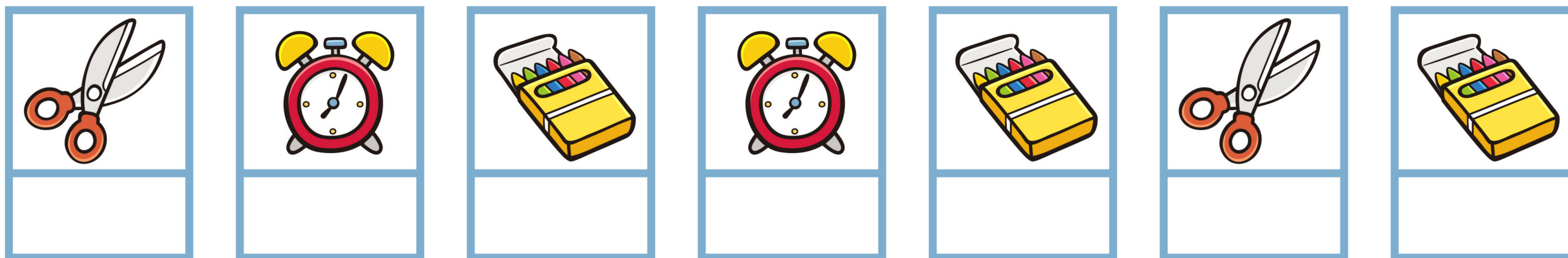
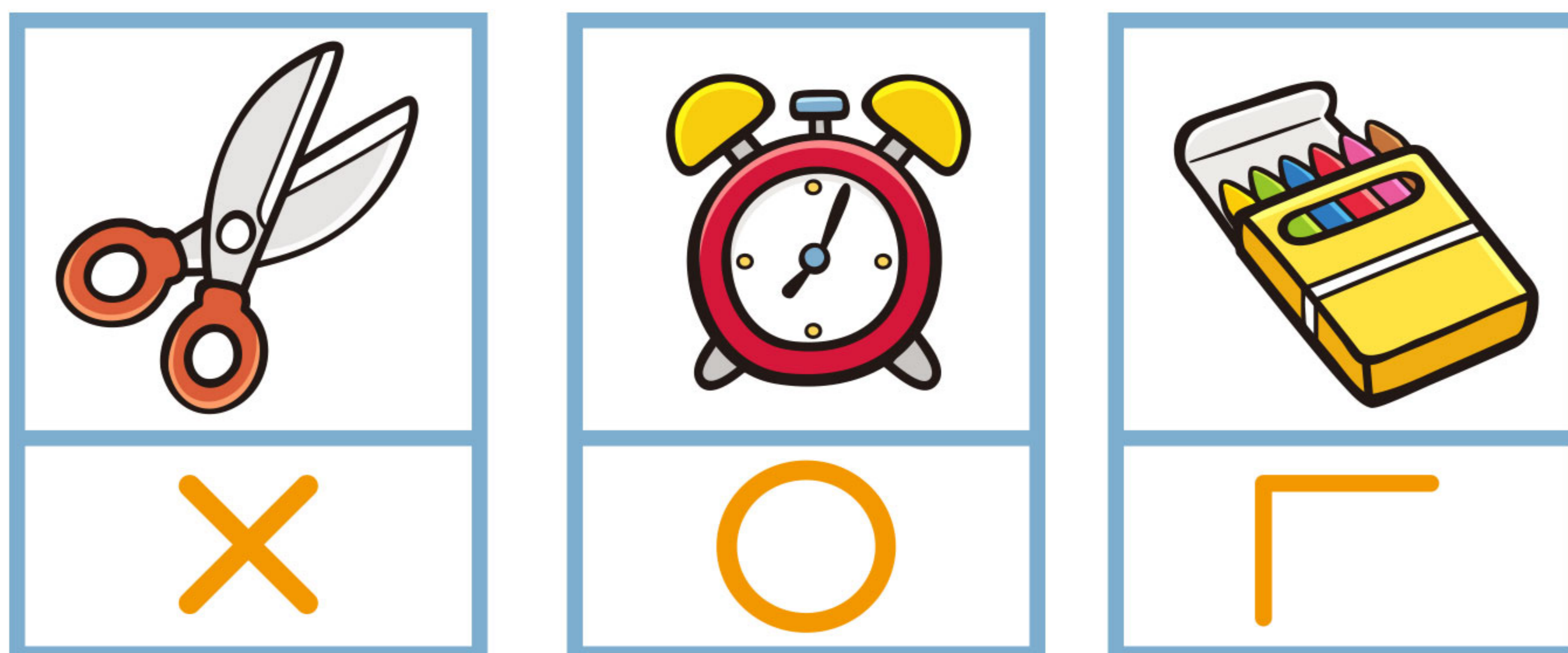

Tacha el objeto que sobra en cada fila

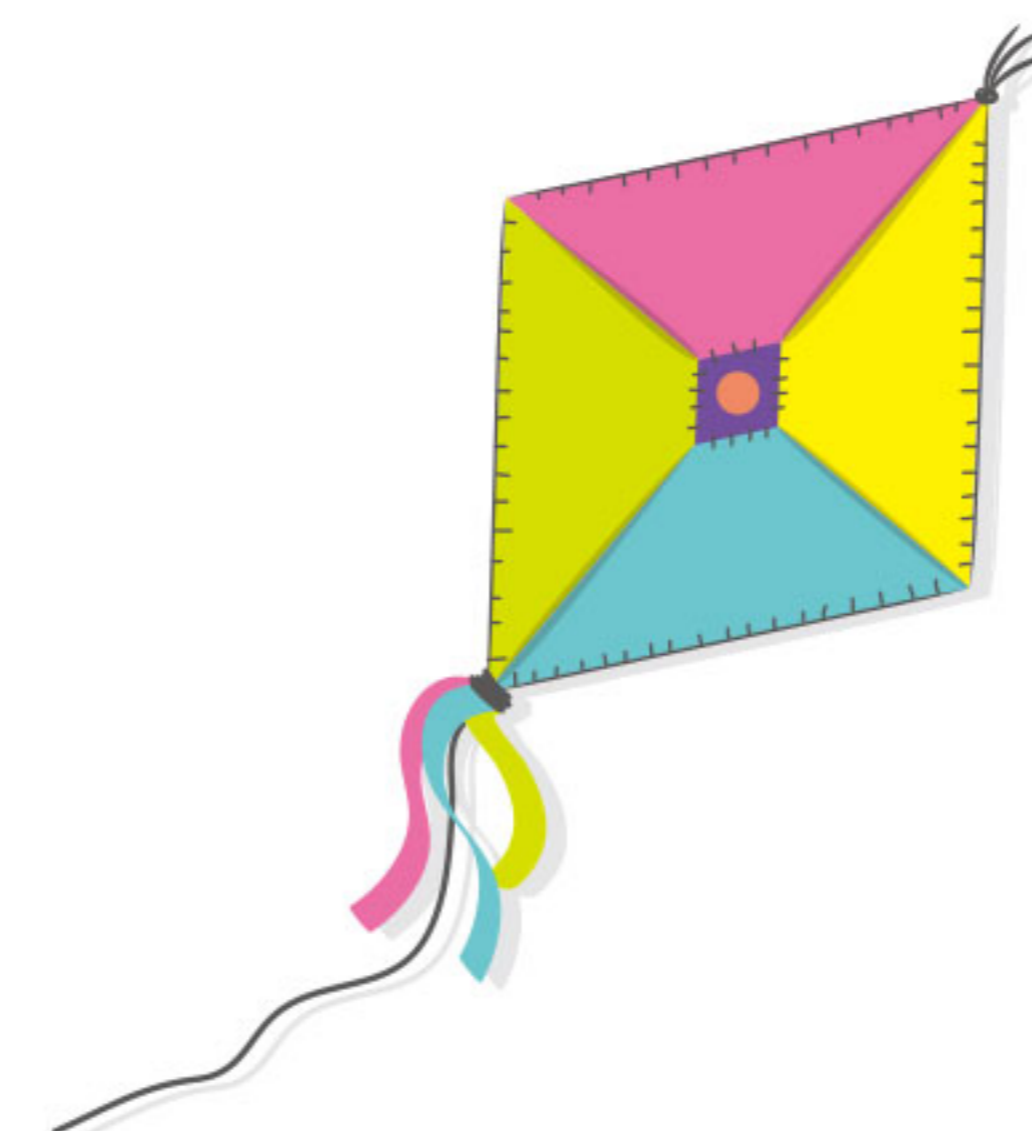
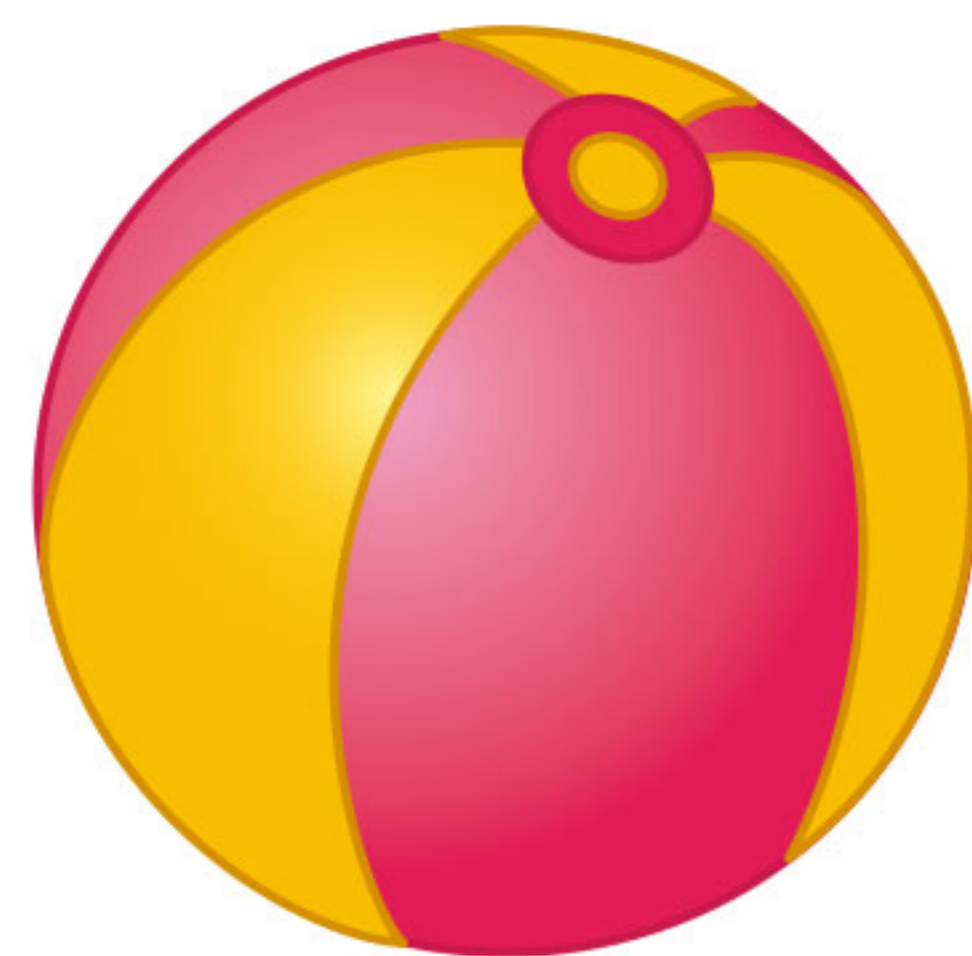
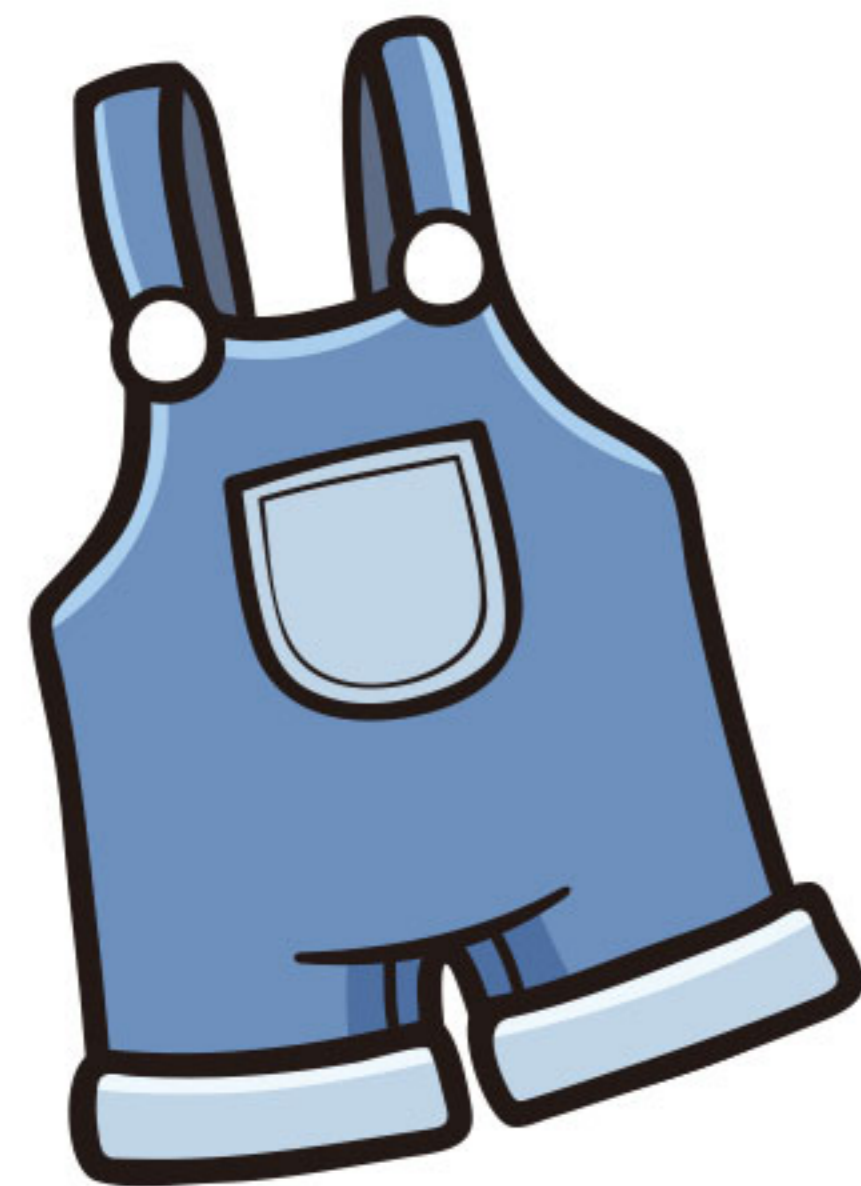

Señala el objeto que completa la serie

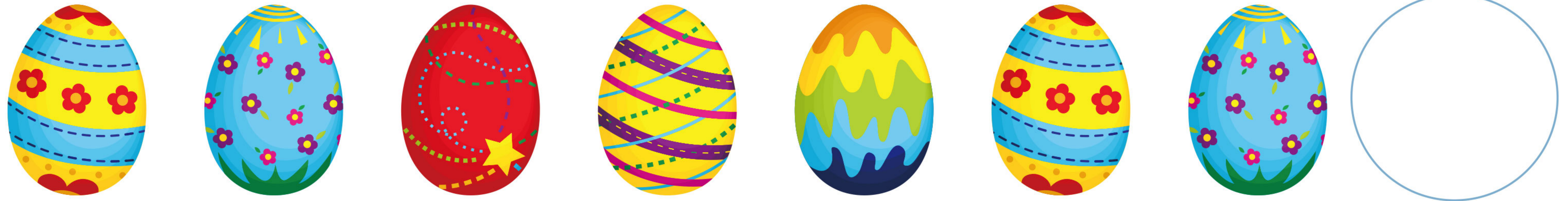



FICHAS PARA TRABAJAR

# NÚMEROS

---



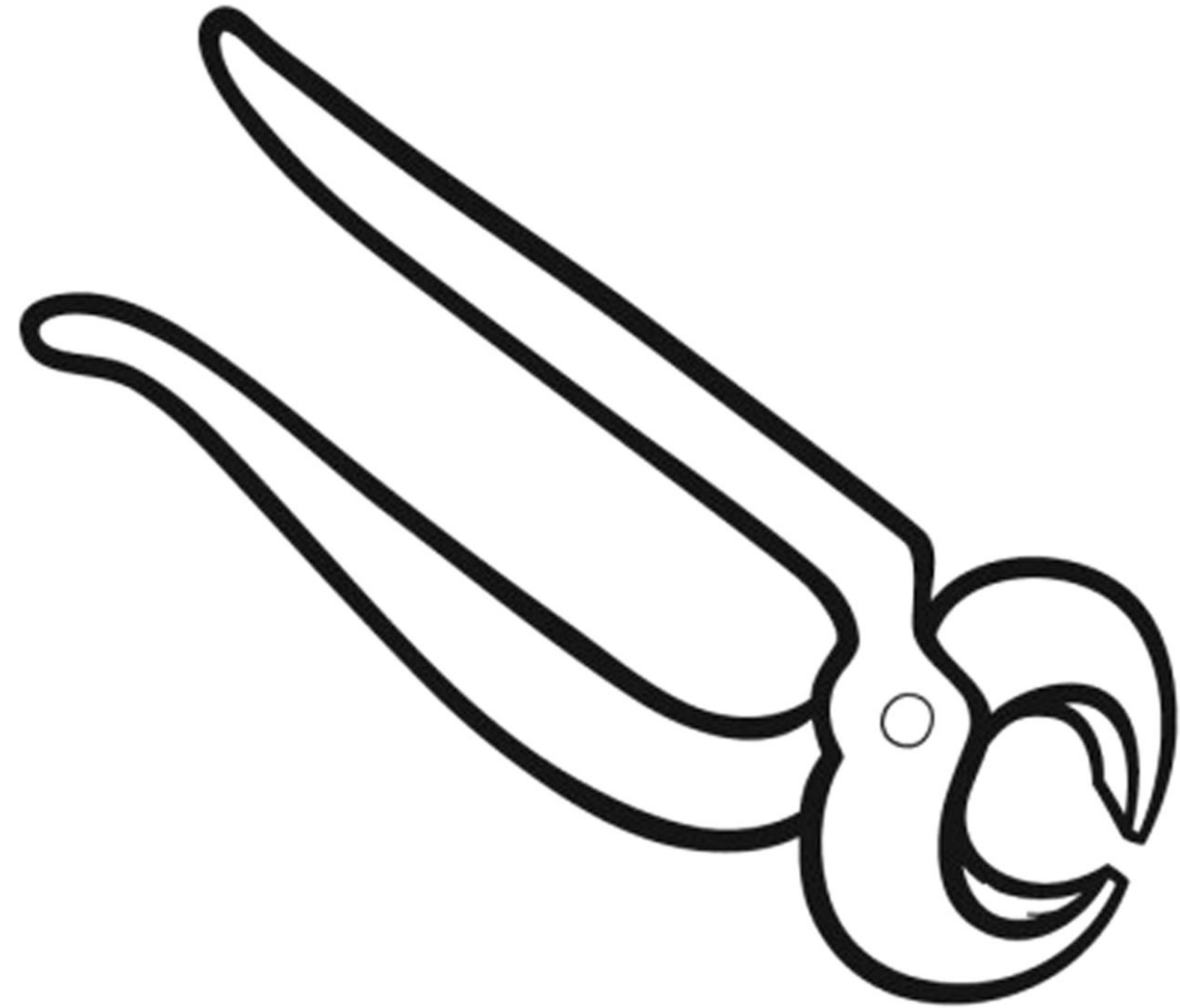
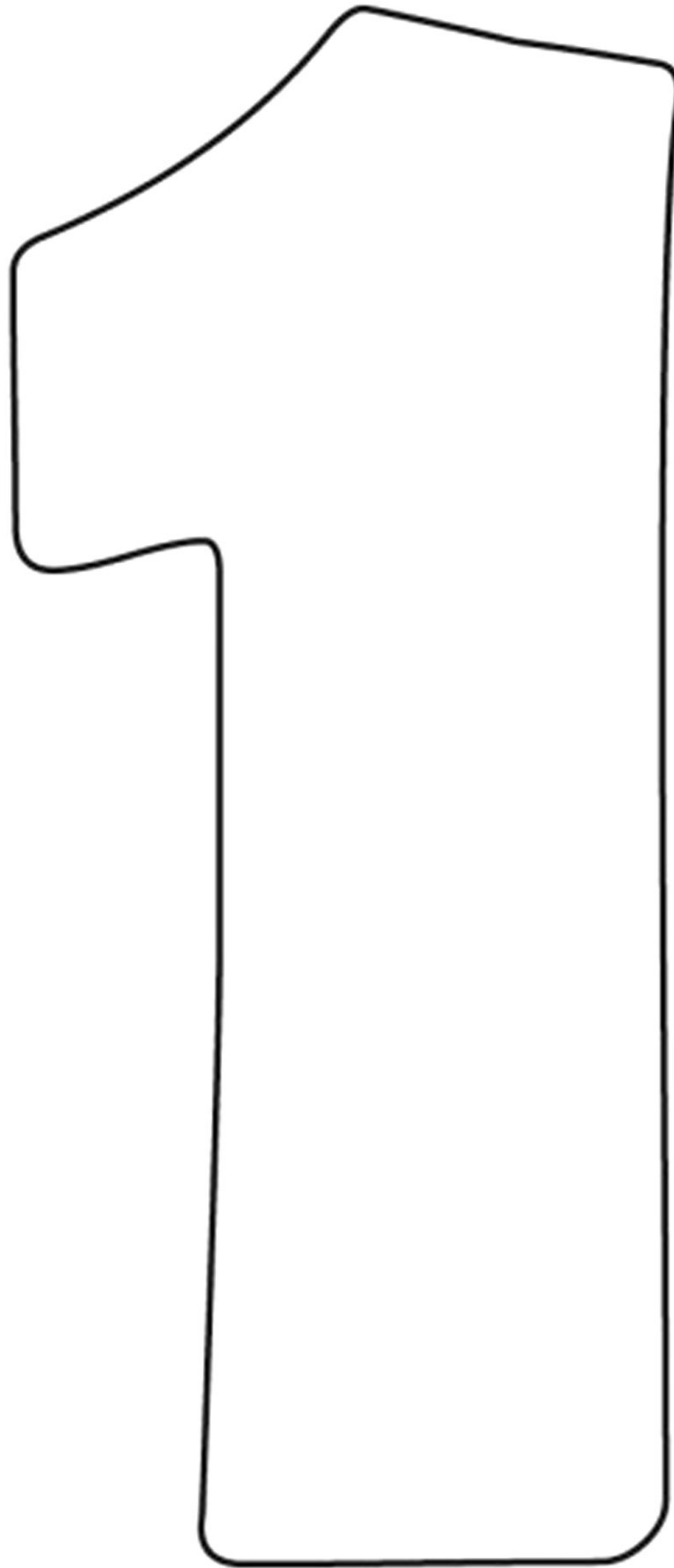

UNO

Colorea 2 manzanas.

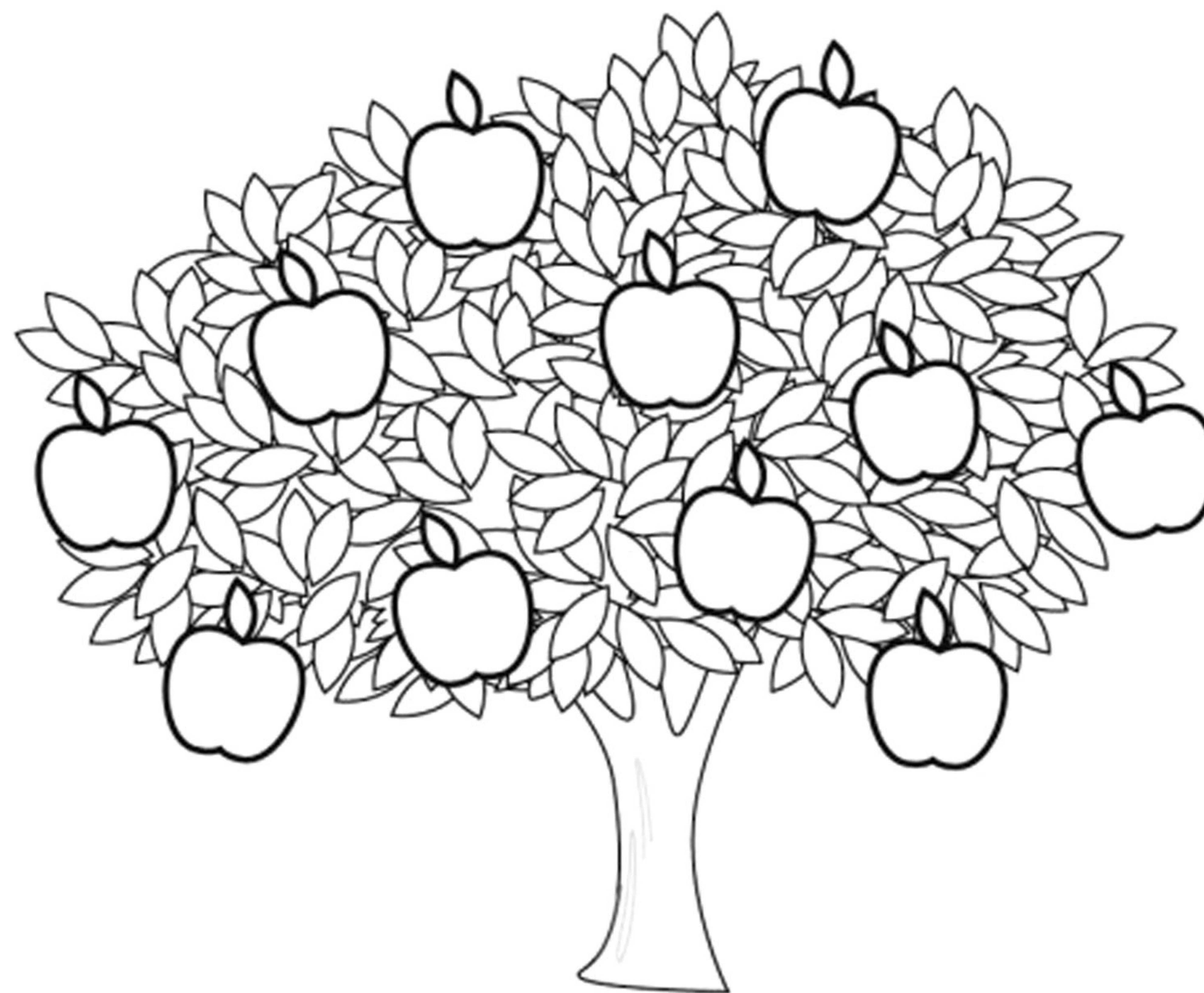
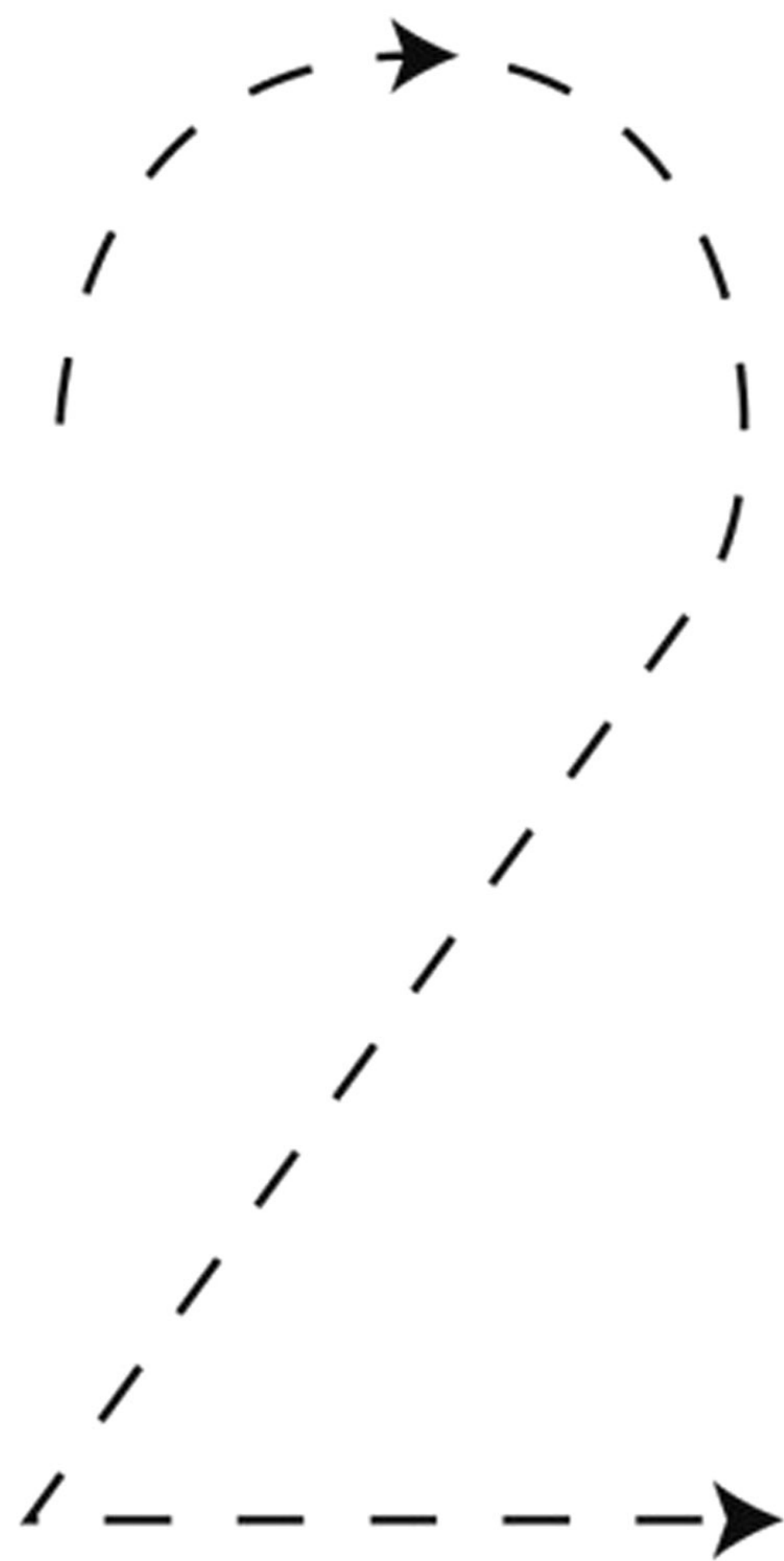

DOS

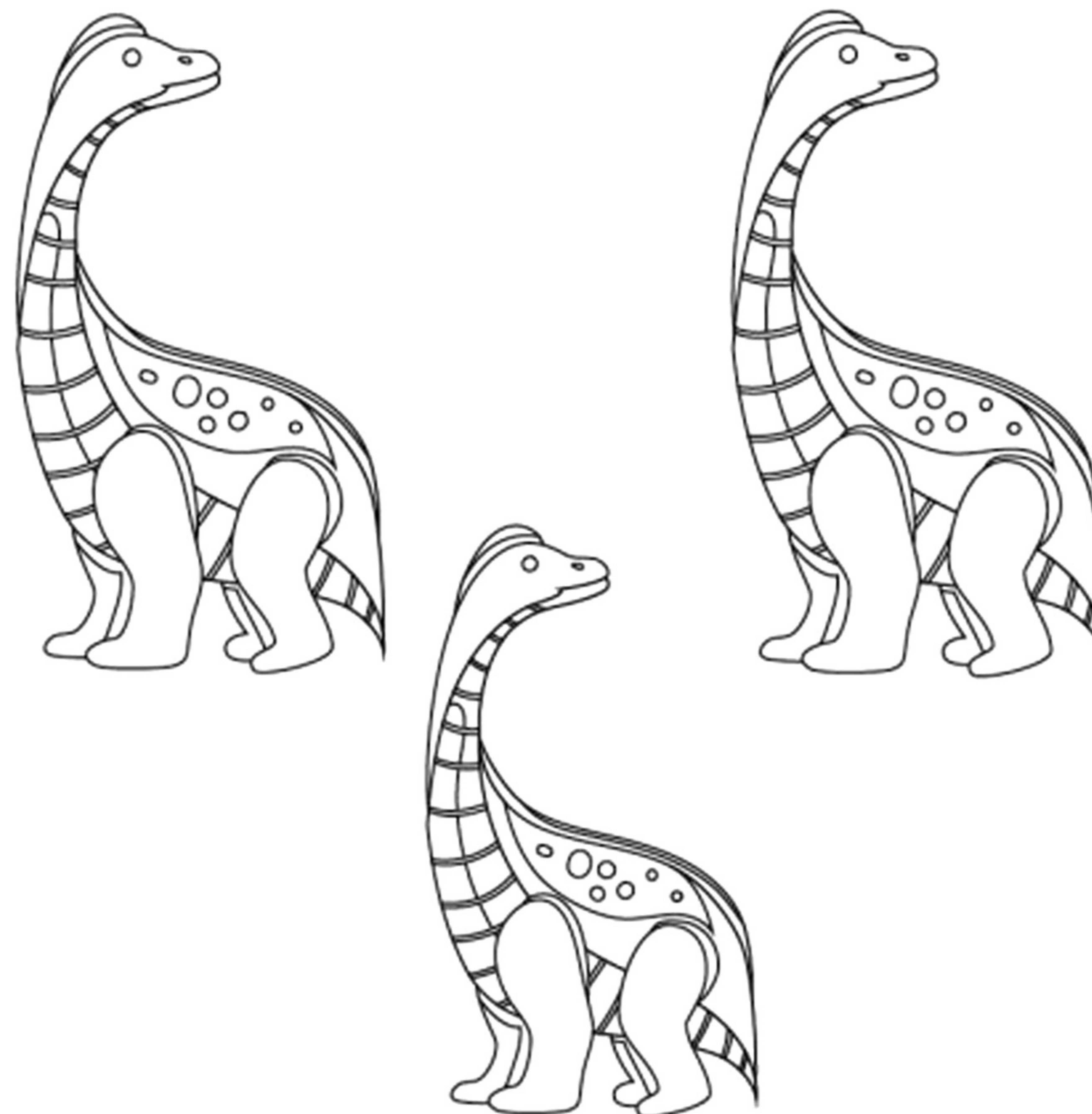
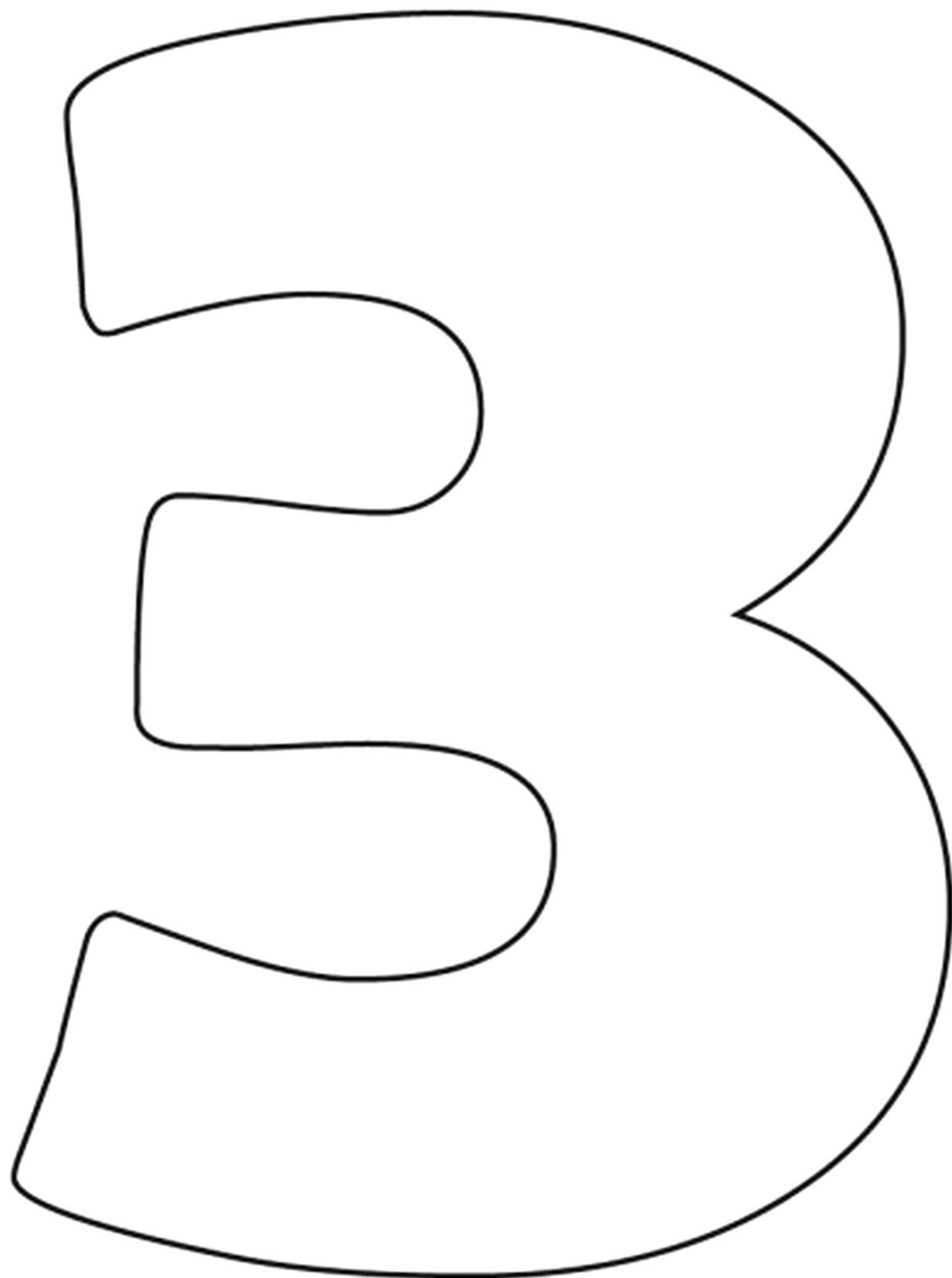

TRES

Colorea 4 animales.

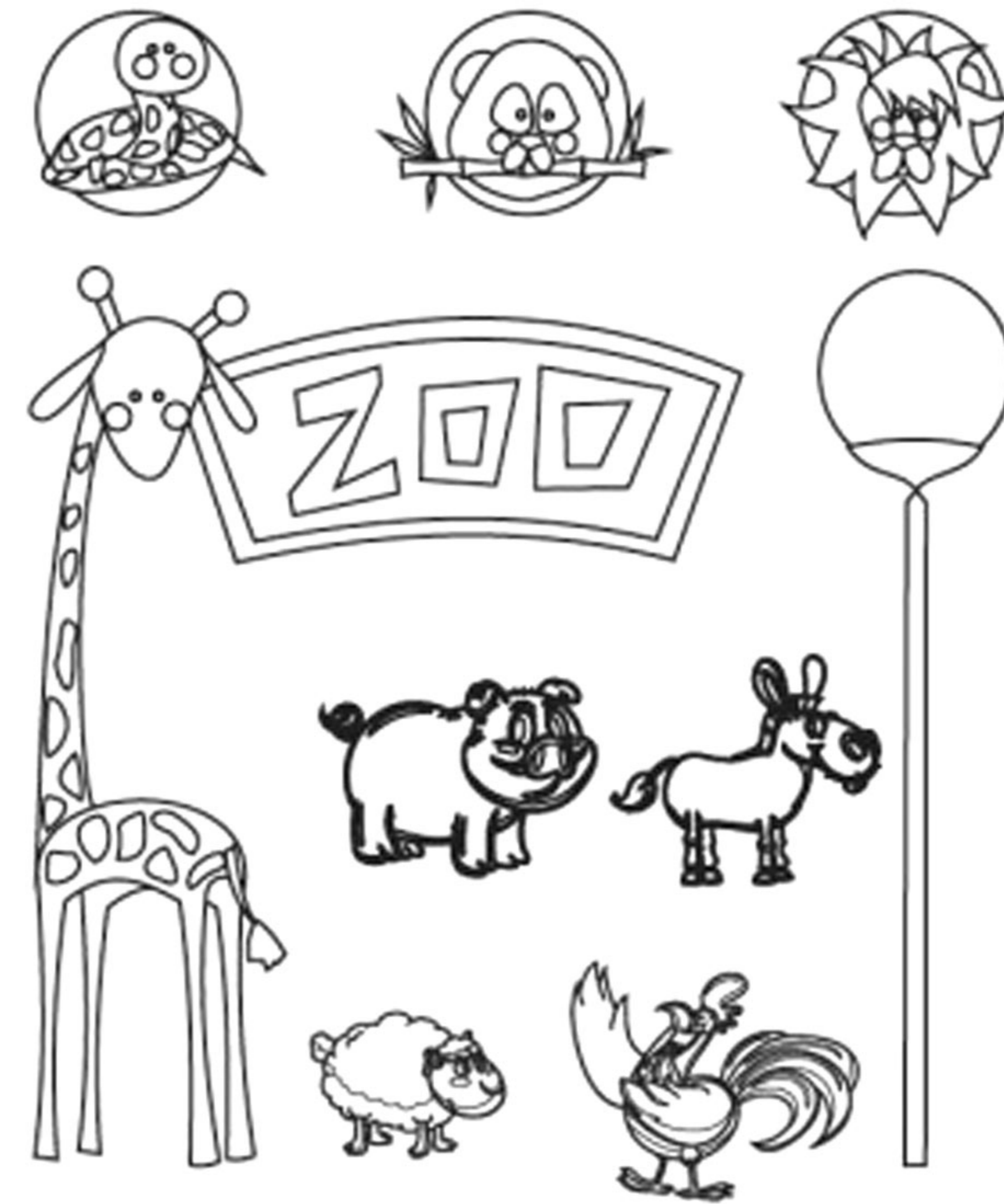
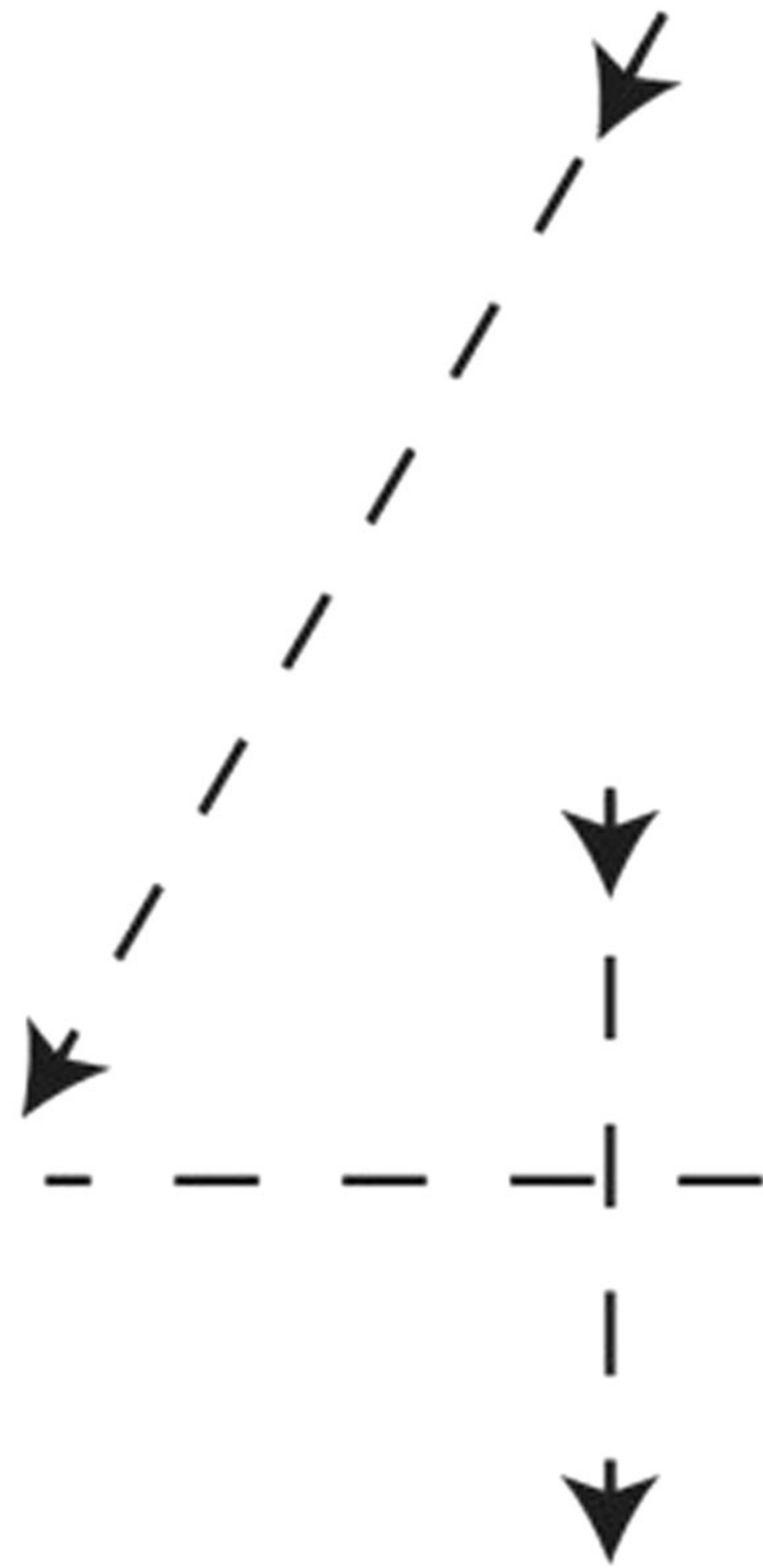

CUATRO

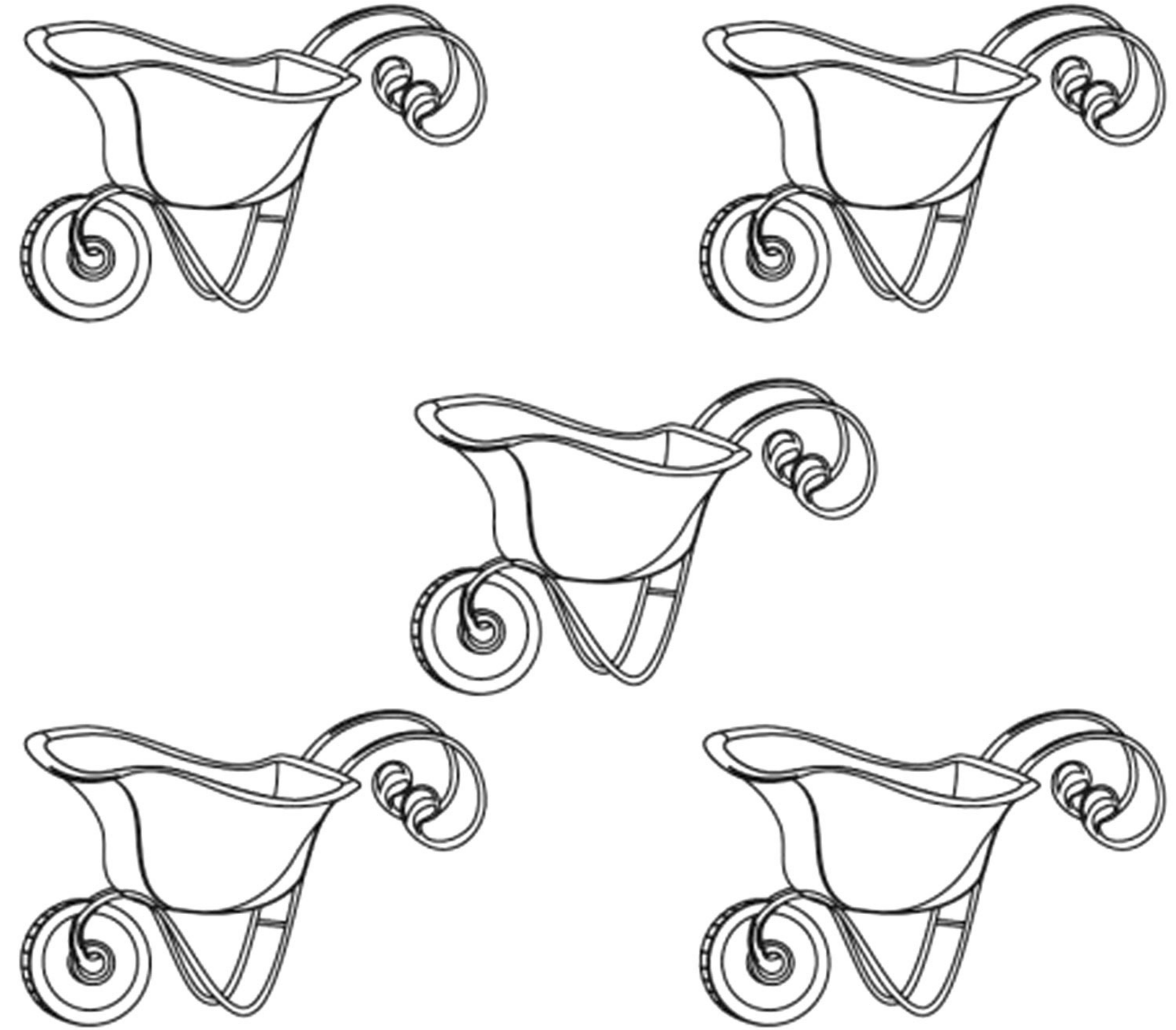

CINCO

Colorea 6 manzanas.

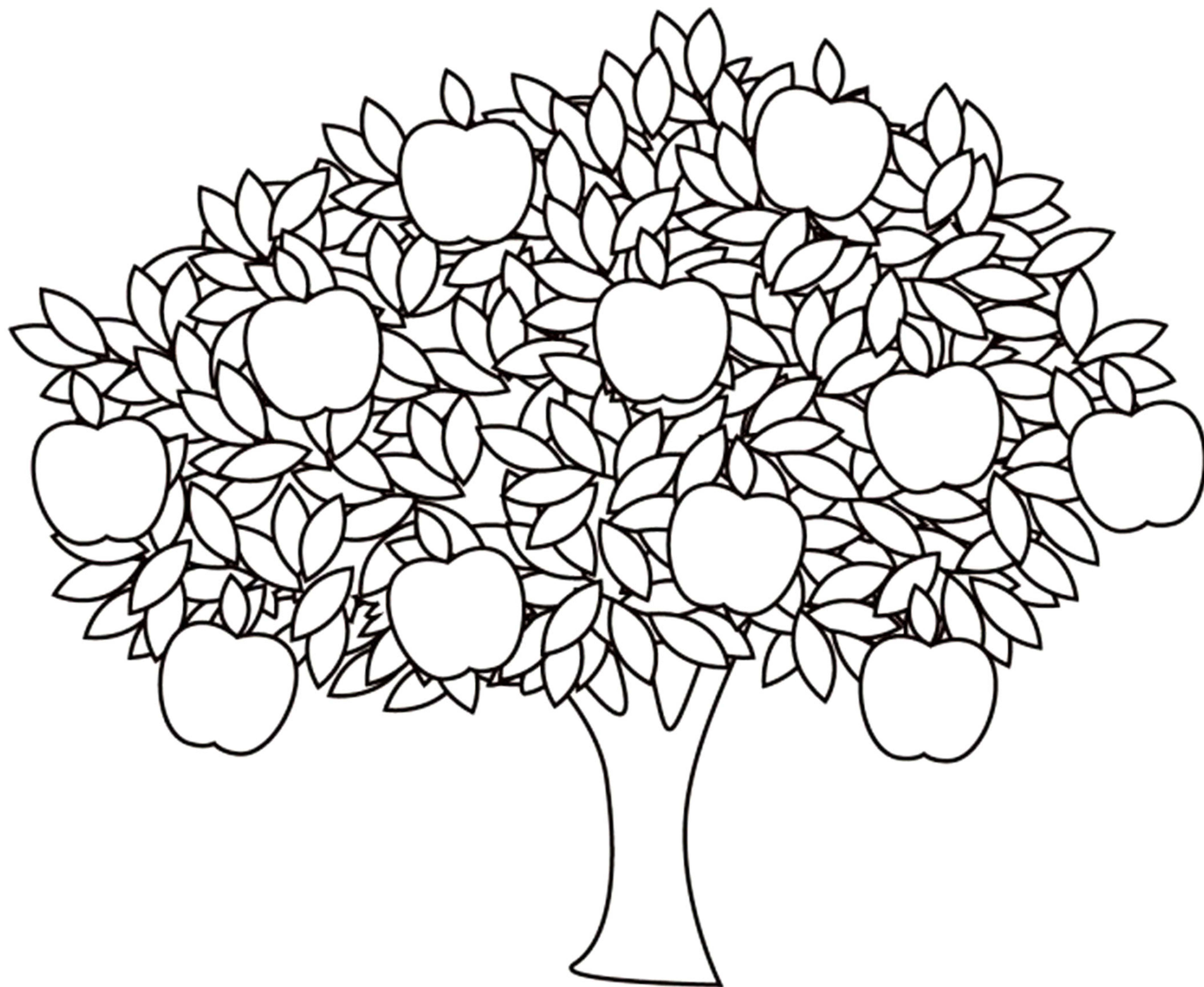
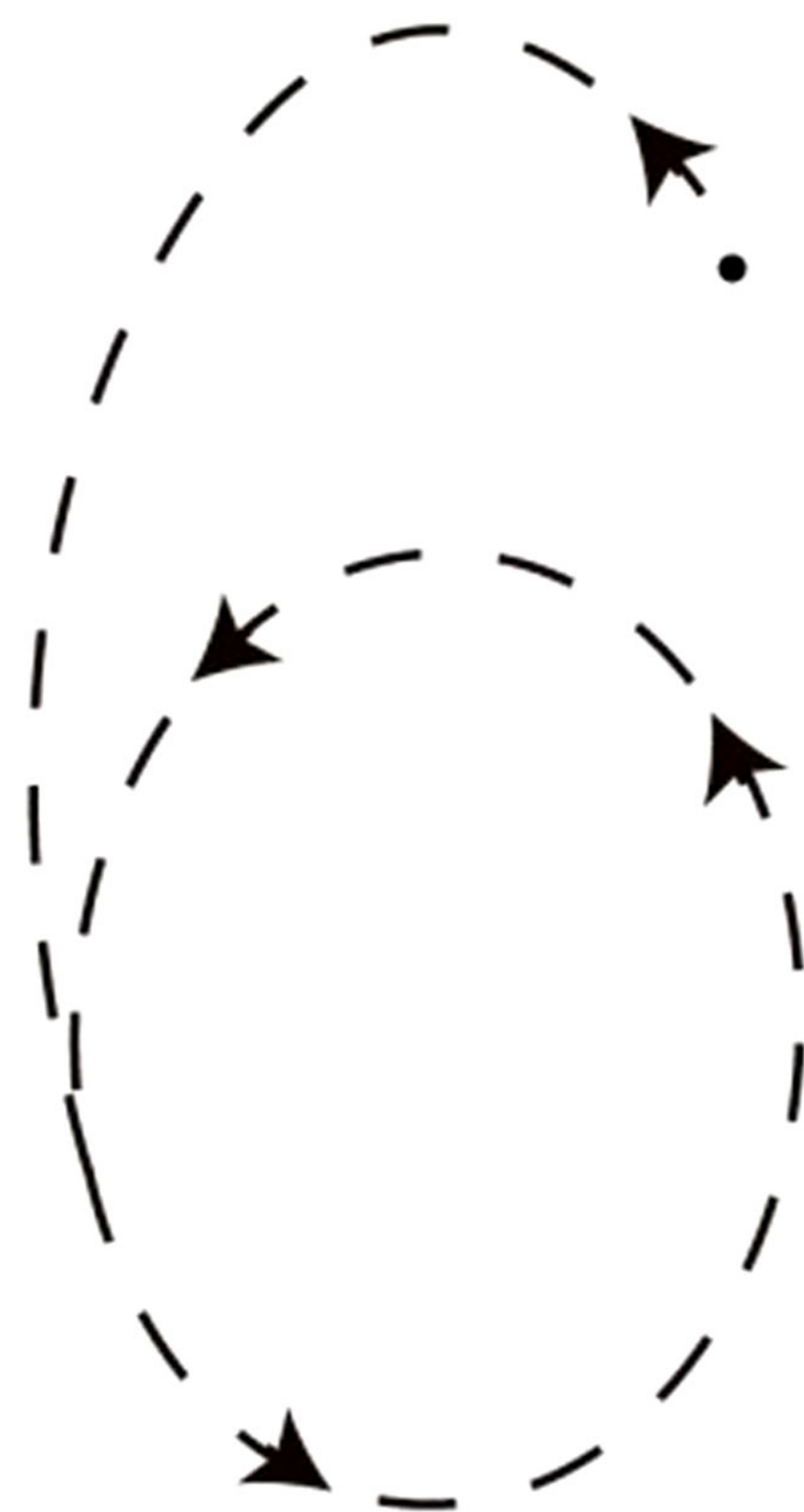

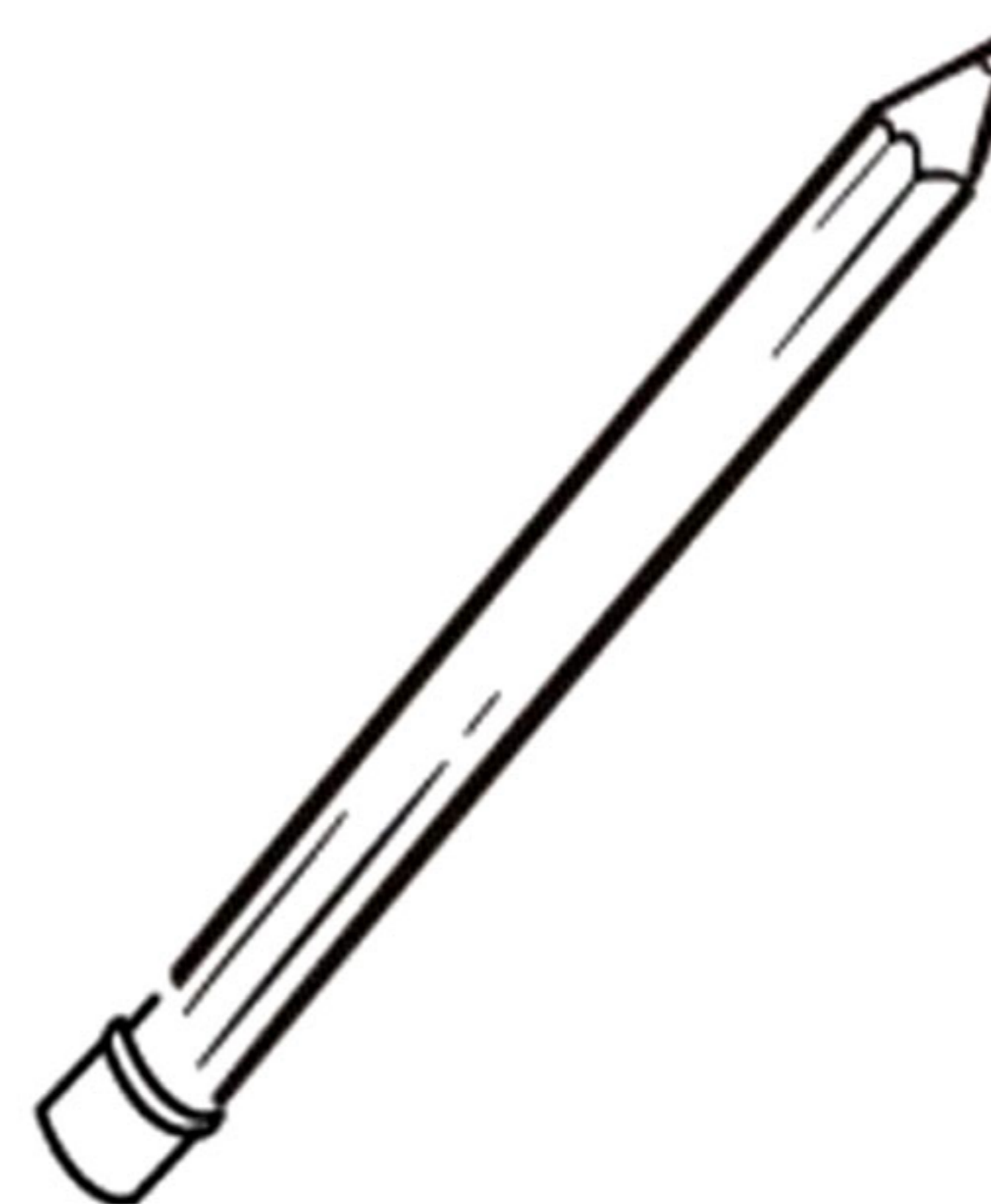
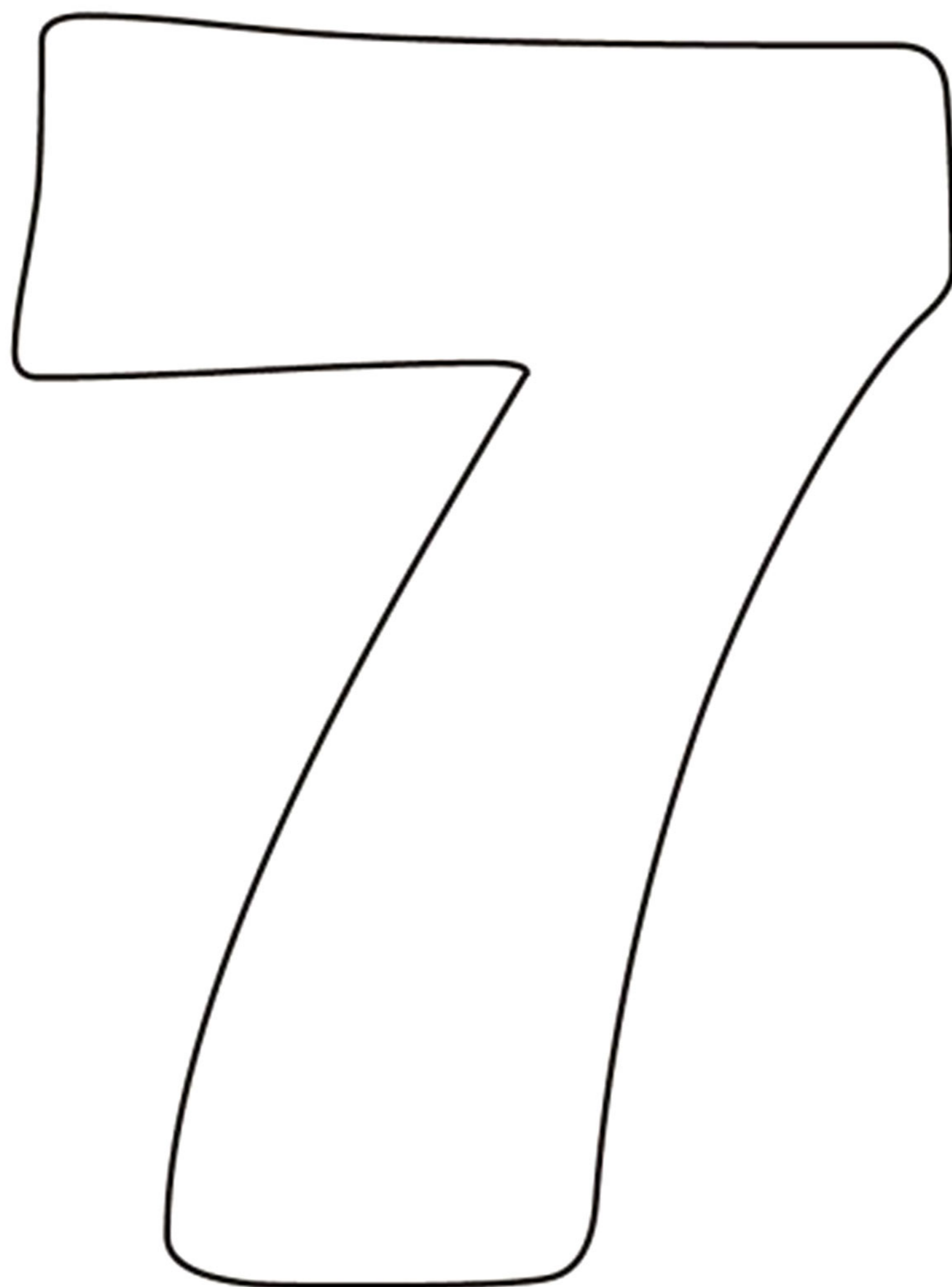



Colorea 8 bolos.

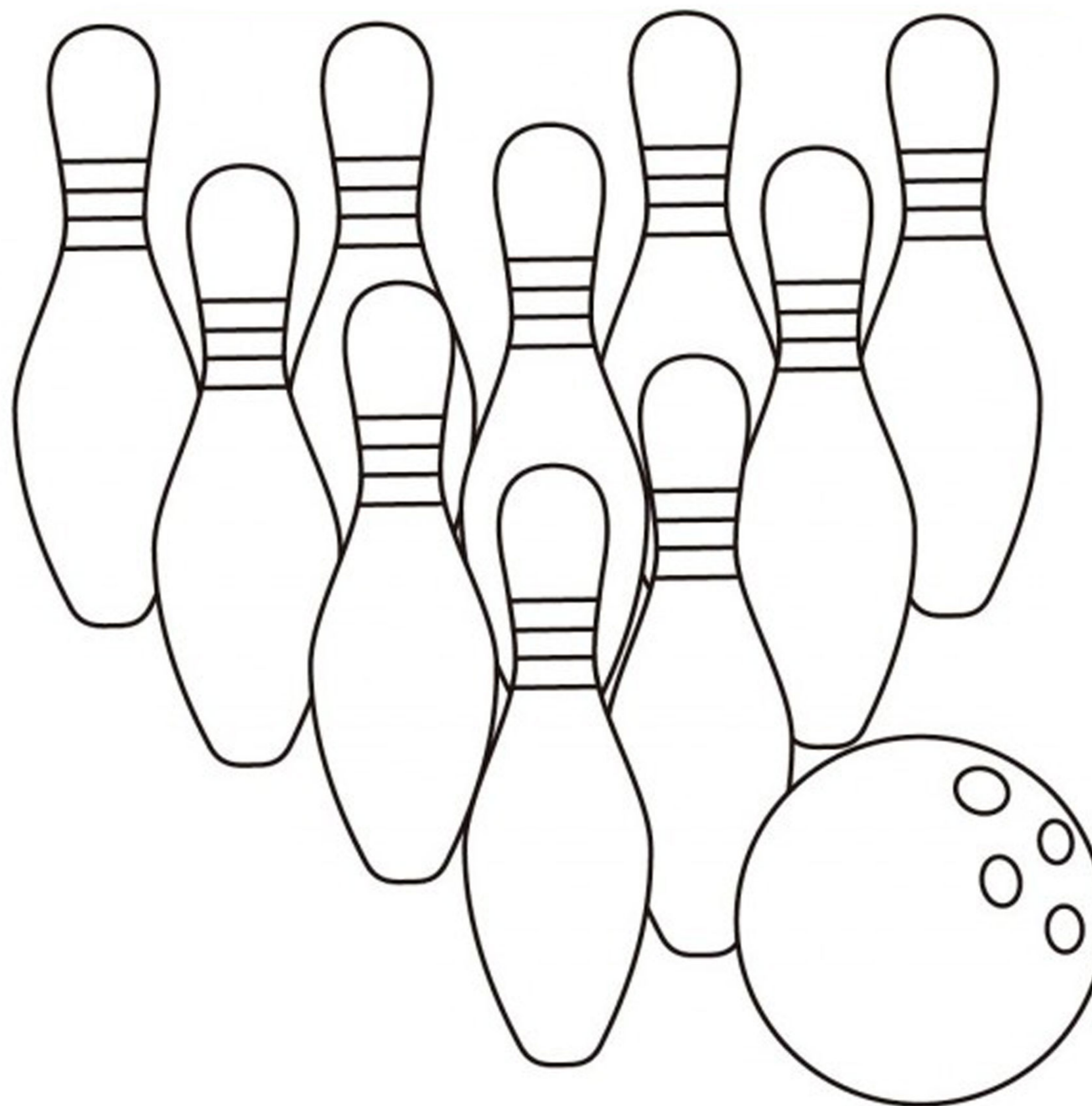
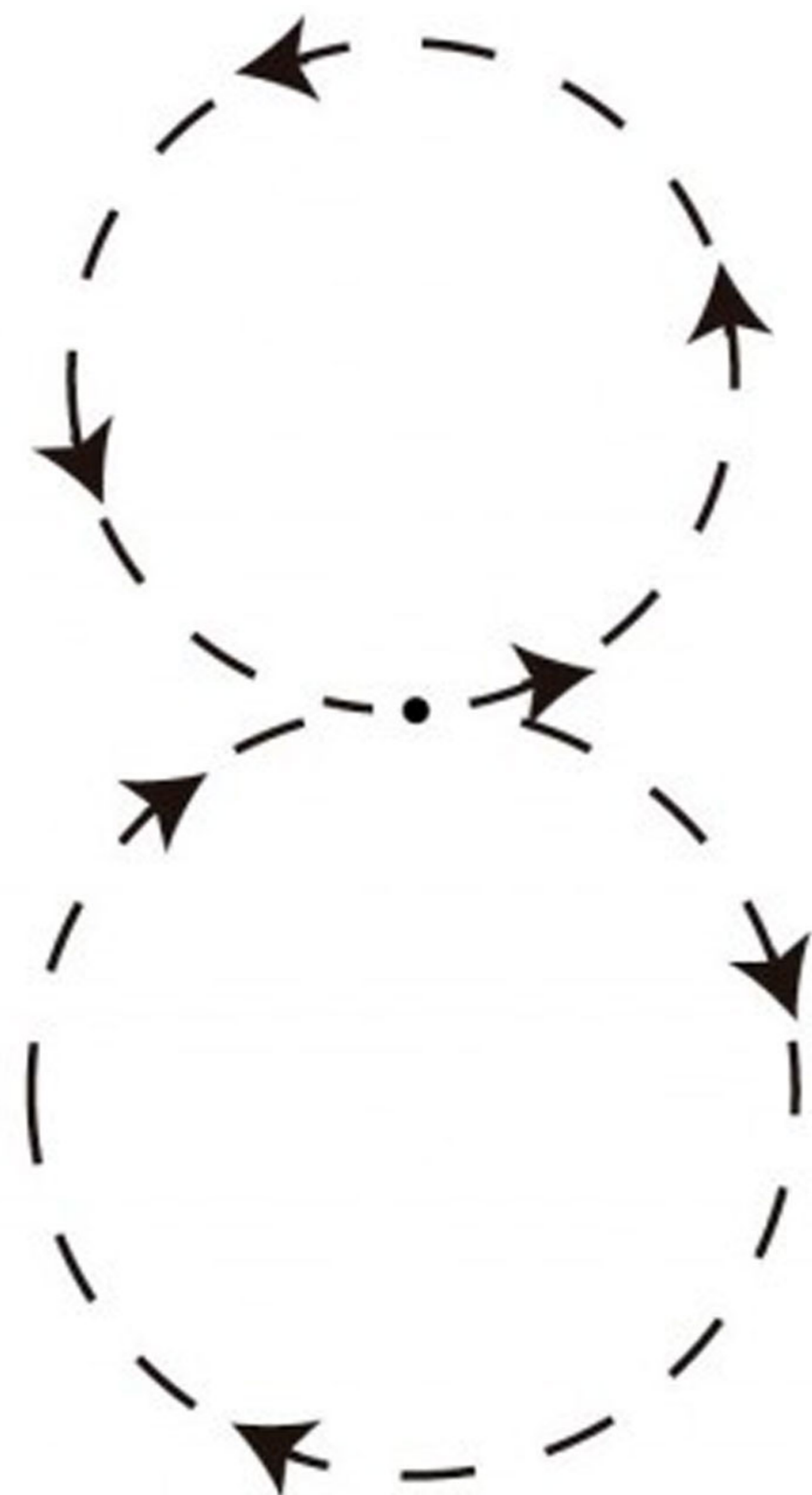

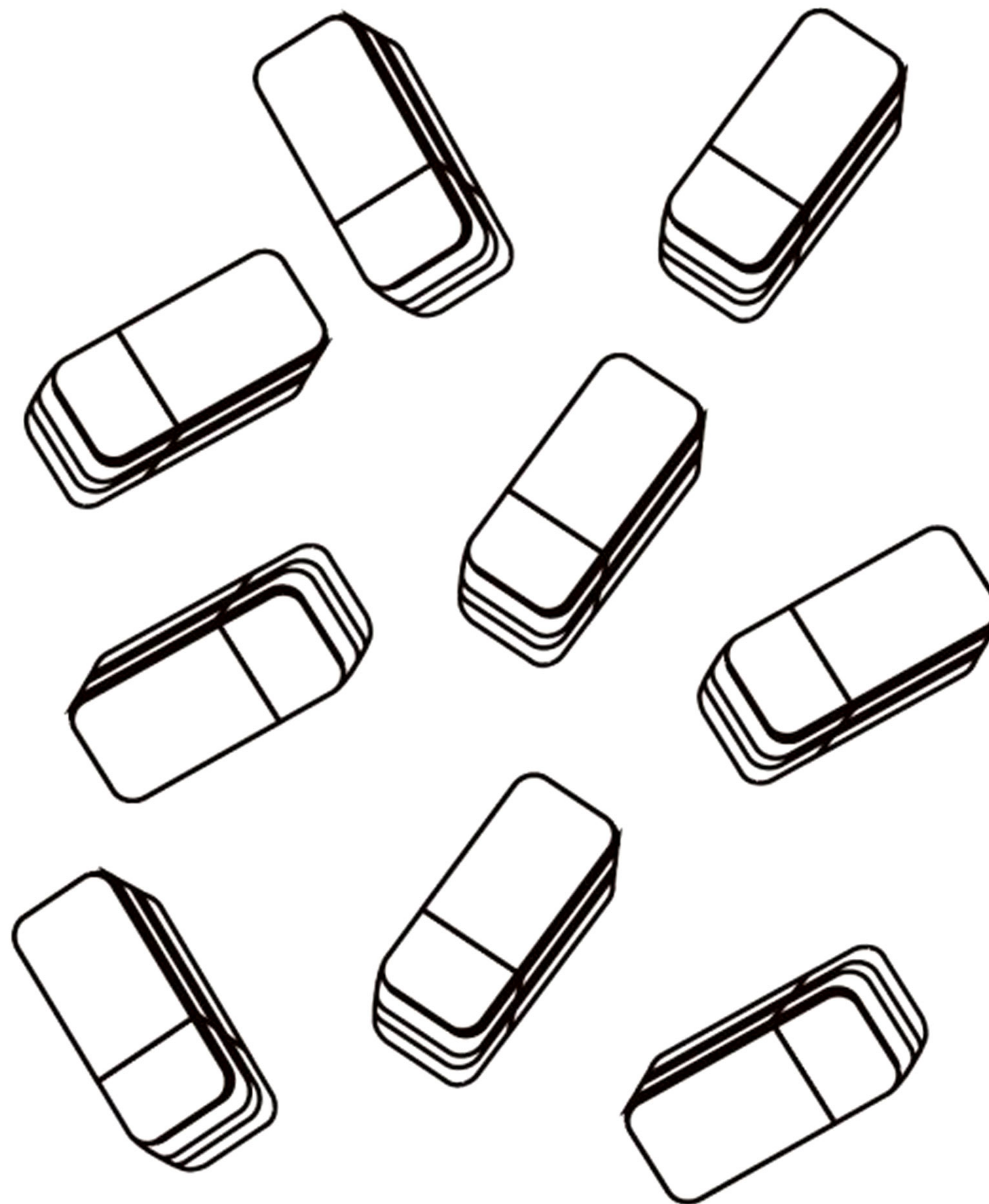
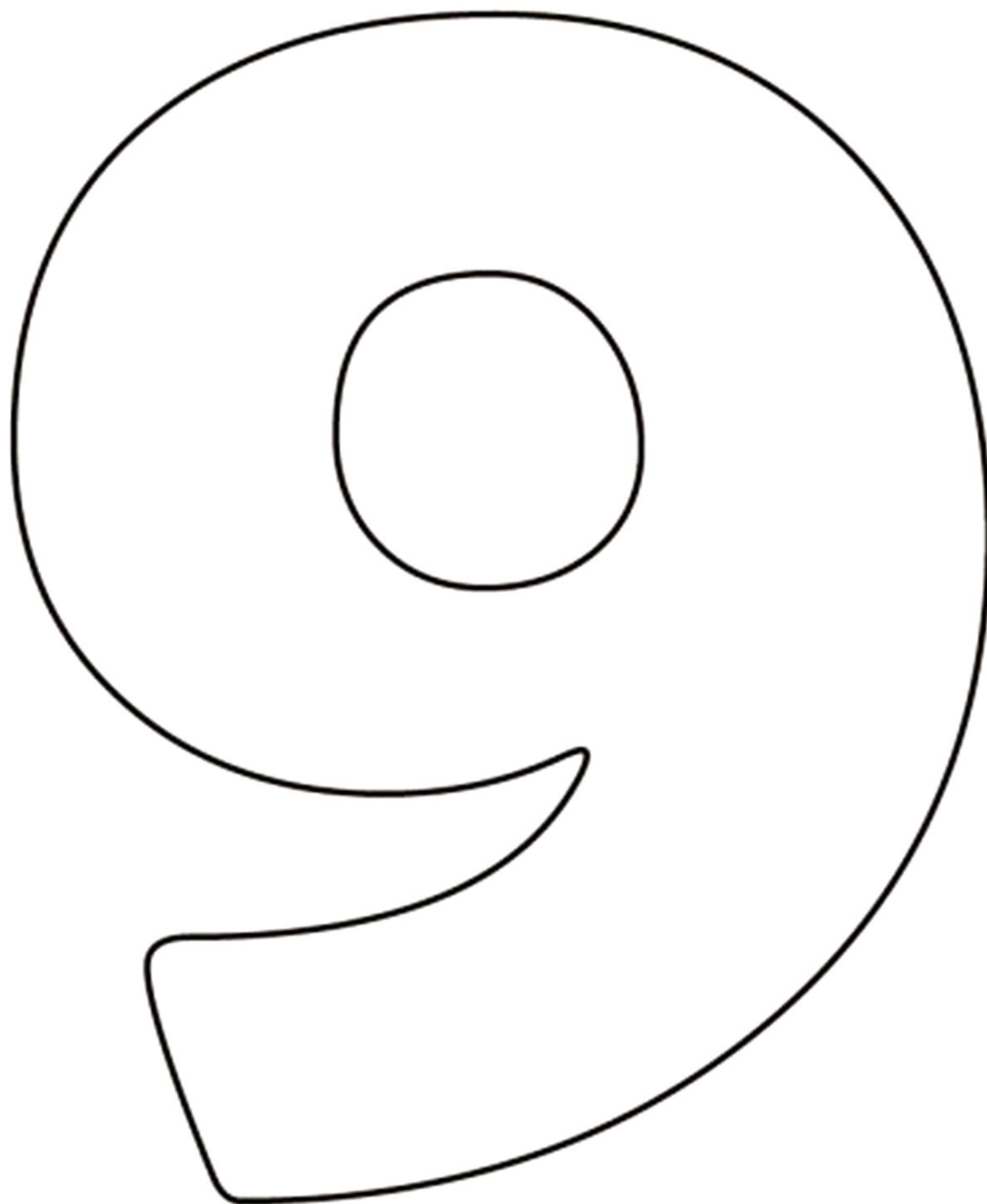

Colorea 10 hojas secas.

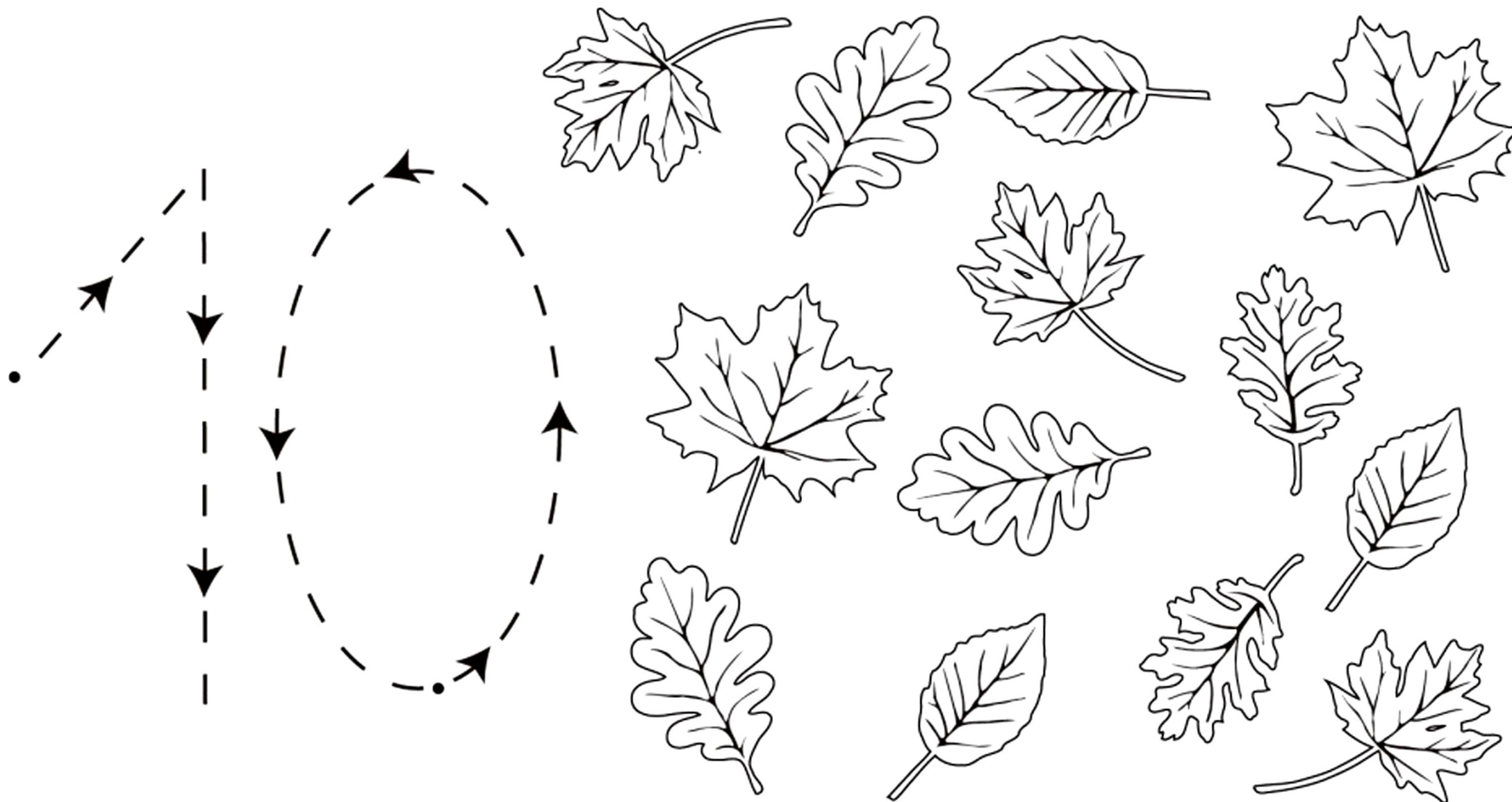

FICHAS DE

# **ESCRITURA**

---



# Repasa los nombres de los objetos

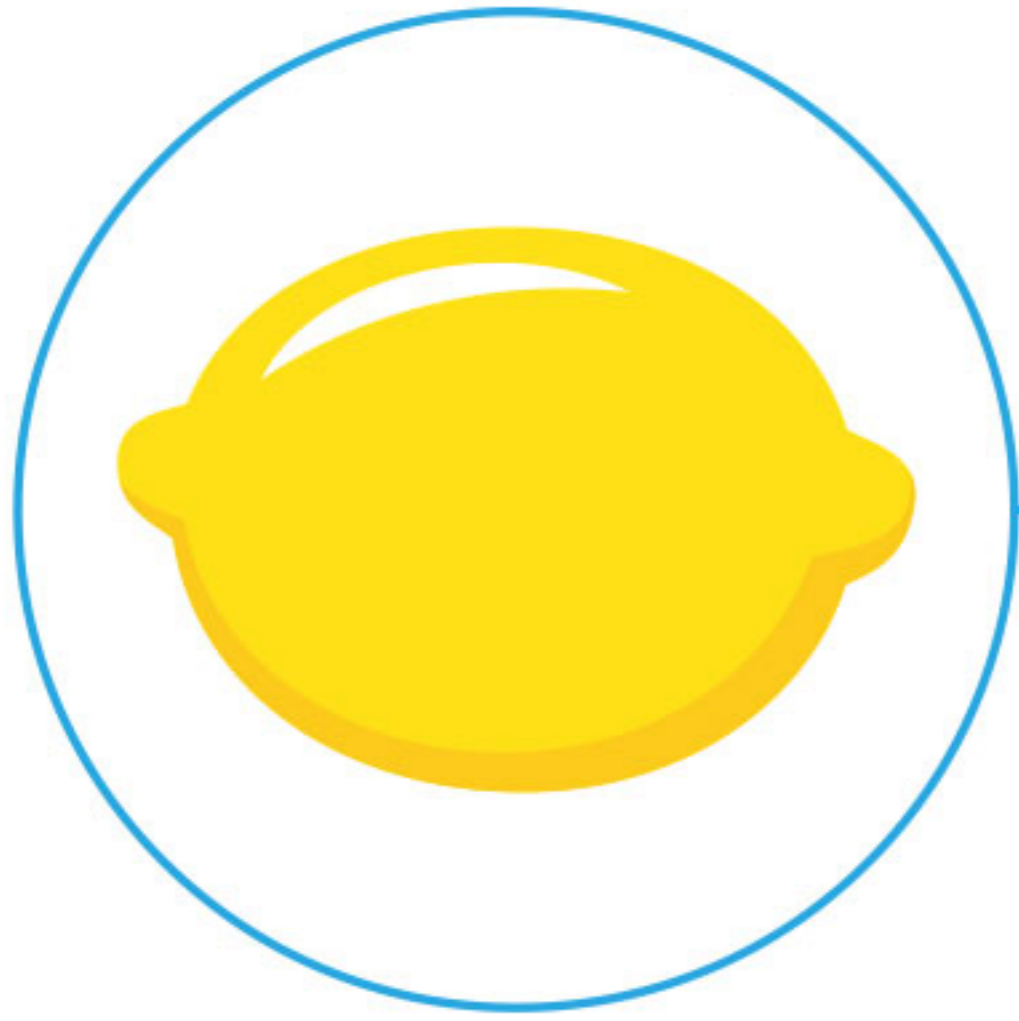

limón



pelota



caballo



avión

# Repasa los nombres de los objetos



autobús



cuaderno



mochila



lápiz

# Repasa los nombres de los objetos

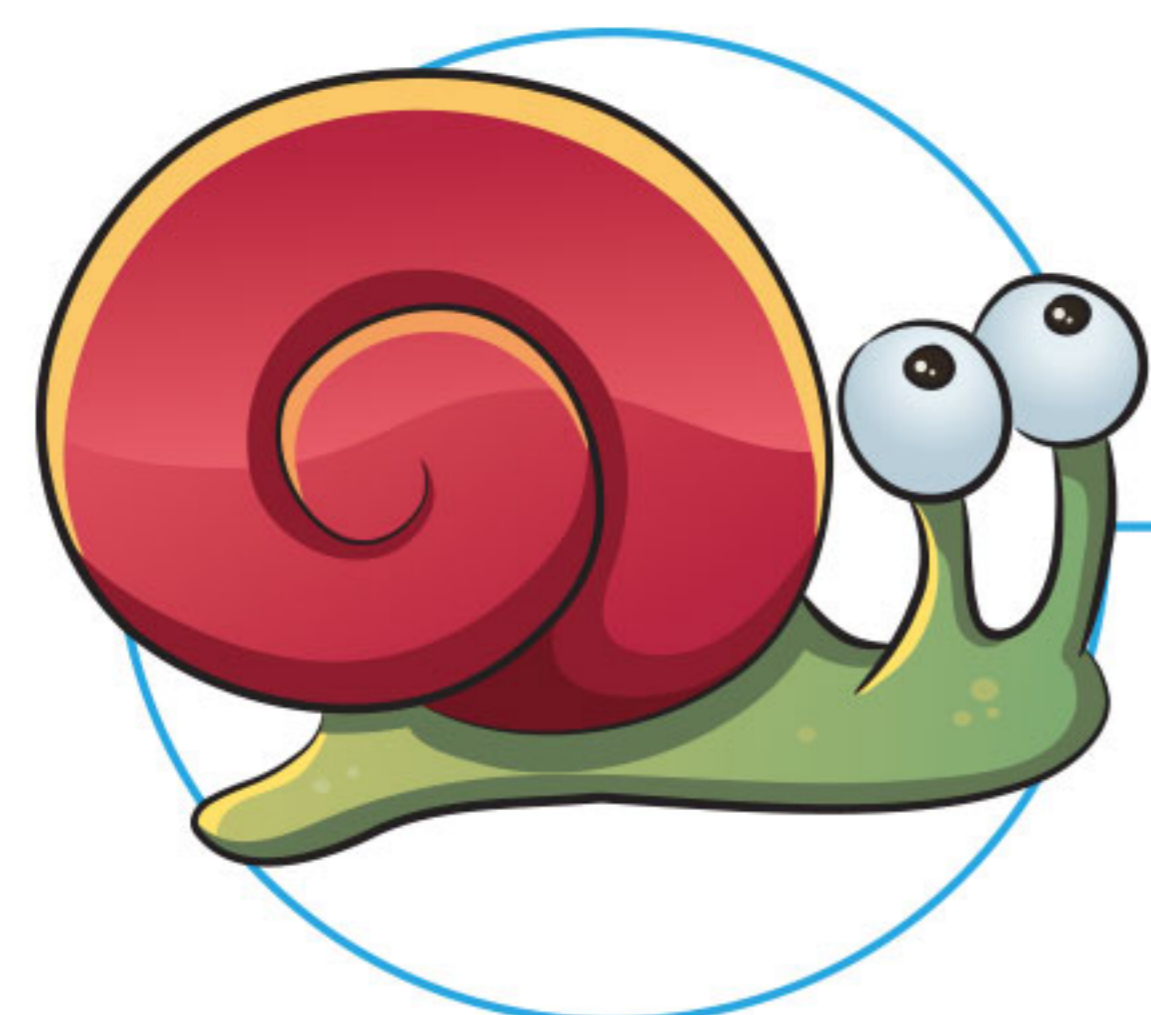

caracol



tigre



pevra

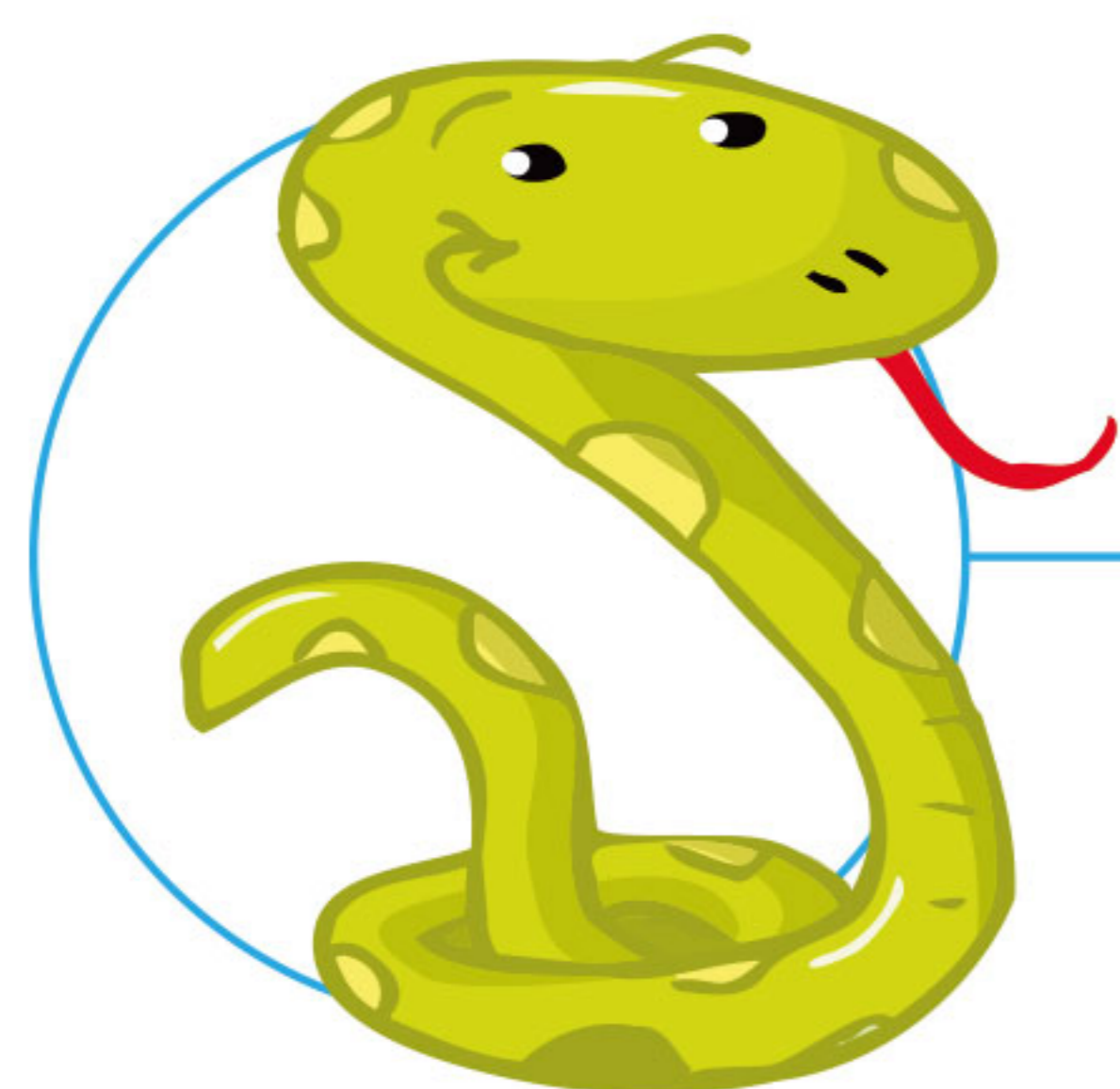

serpiente

# Repasa los nombres de los objetos



tesoro



pirata



luna



sol



# Repasa los nombres de los objetos



zapatilla



sombrero

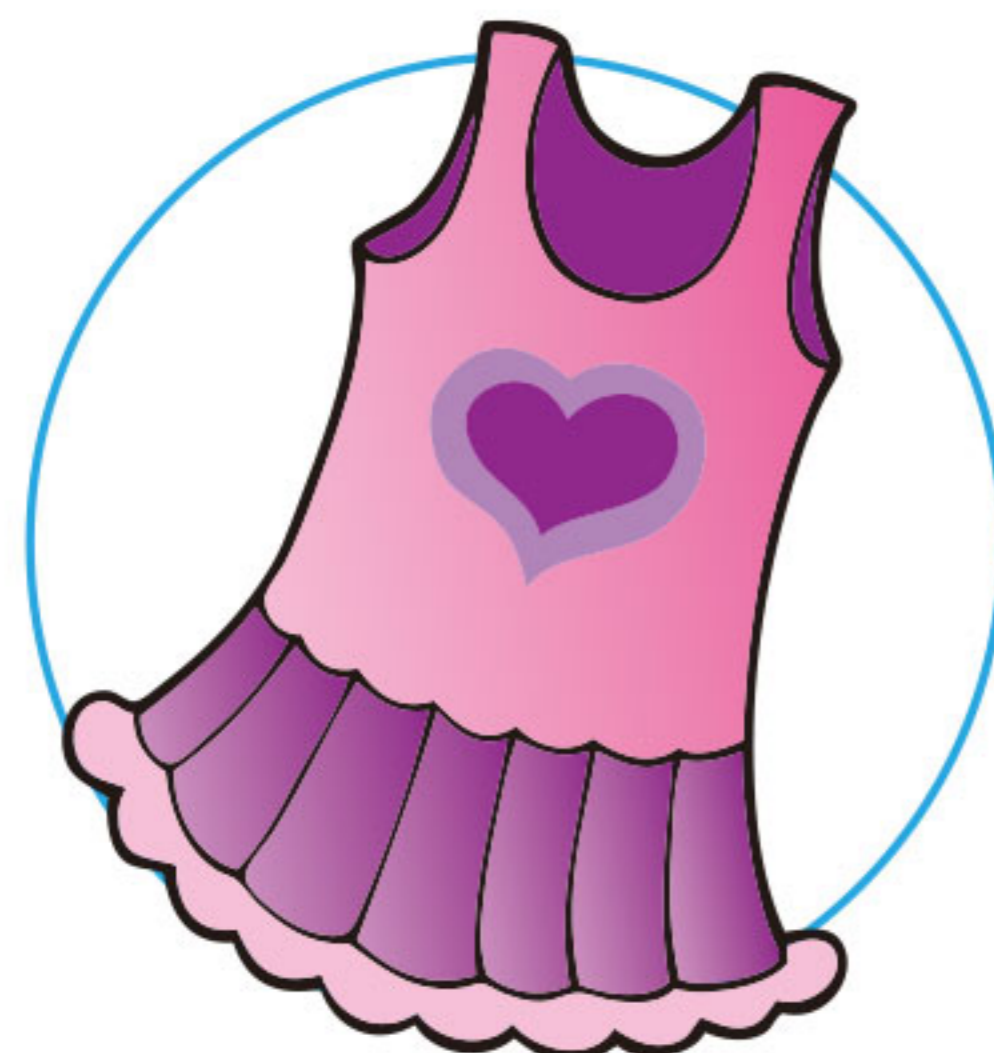

vestido

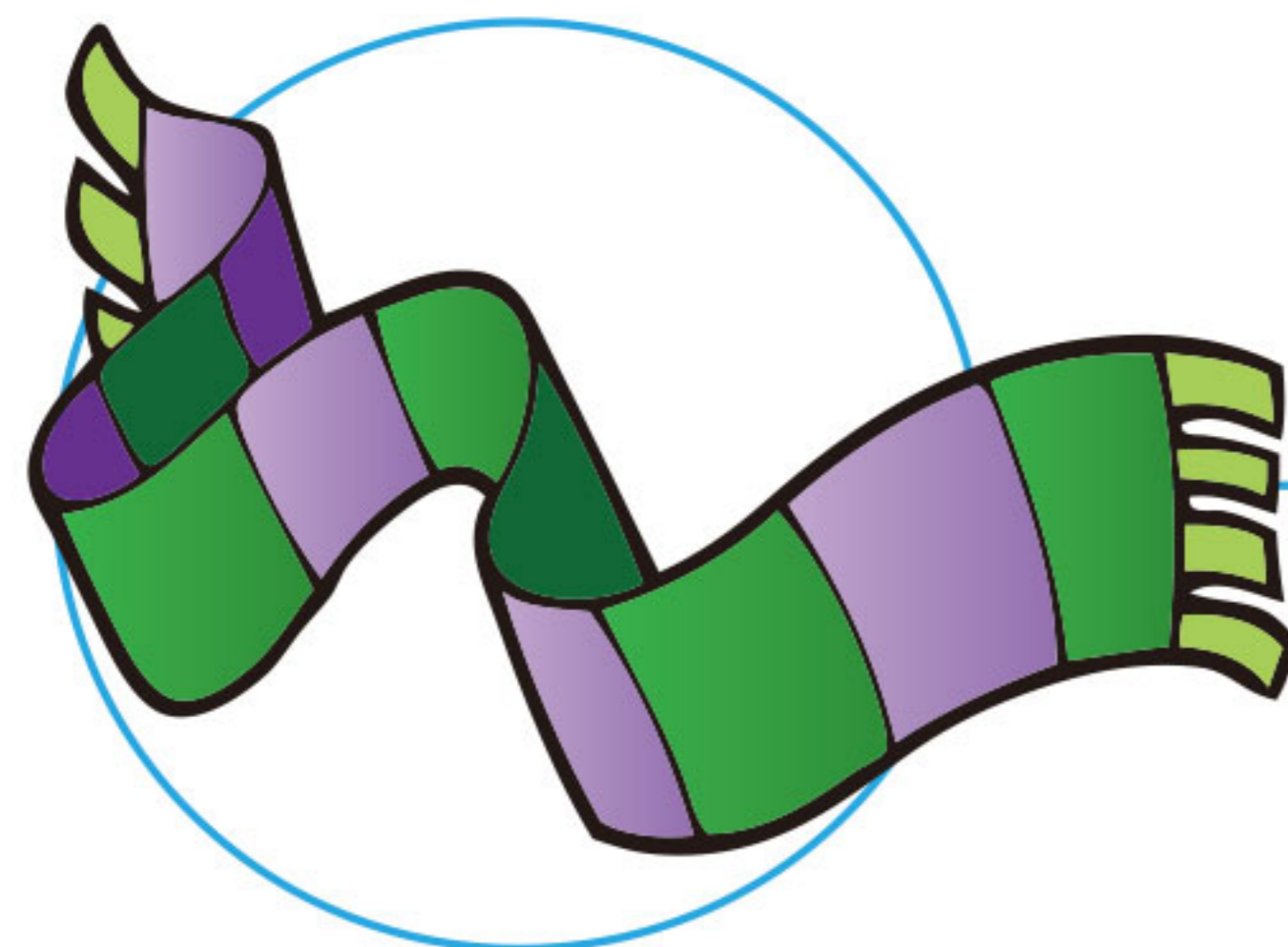

bufanda

Escribe el nombre del objeto fijándote  
en el modelo

bota



taza



Escribe el nombre del objeto fijándote  
en el modelo

galleta



helado



Escribe el nombre del objeto fijándote  
en el modelo

manzana



mochila



FICHAS DE  
**LECTURA**

---

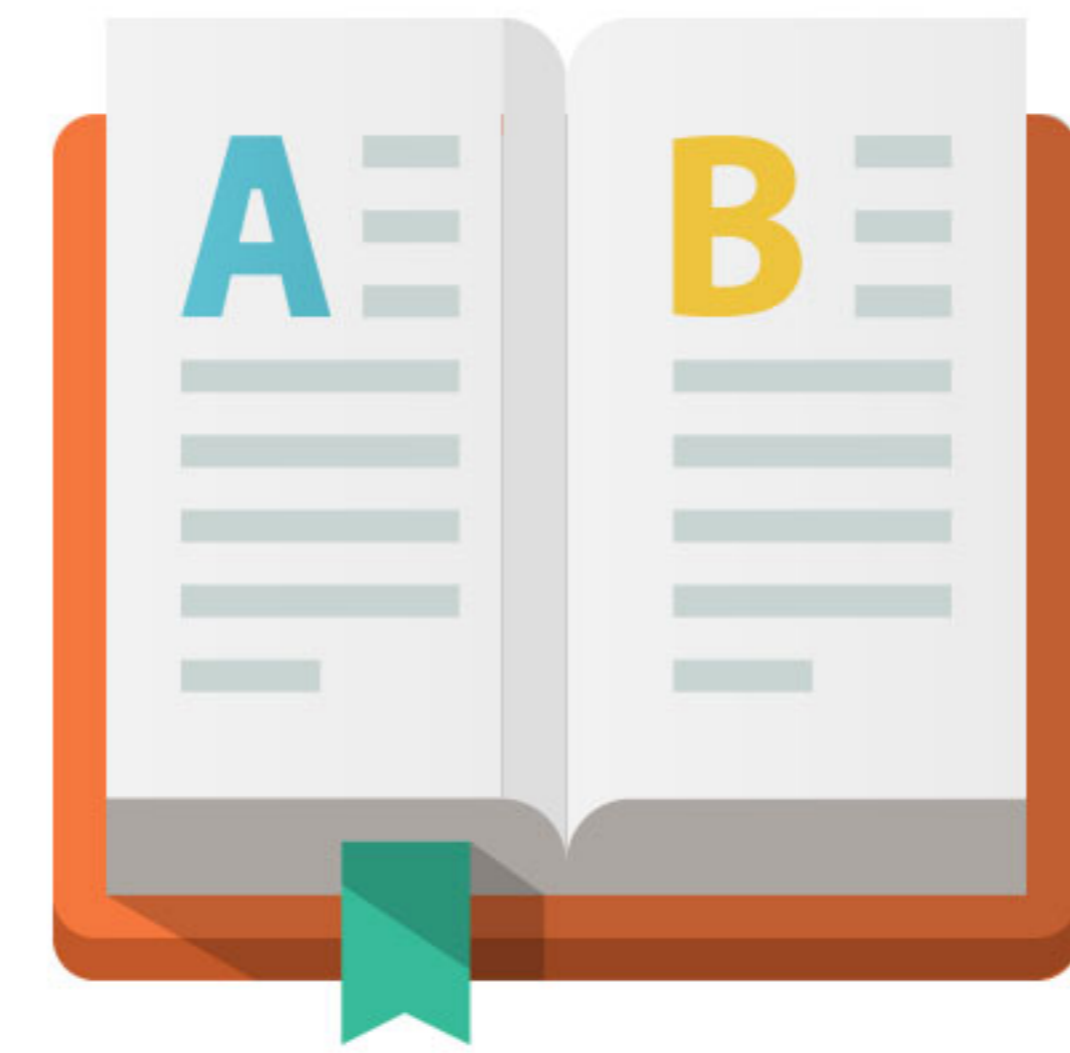

Une con una flecha el objeto y su nombre

Piano

Koala

Helado

Submarino



Une con una flecha el objeto y su nombre

Pájaro

Pelota

Coche

Zapatilla



Une con una flecha el objeto y su nombre

Oso de peluche

Luna

Jarrón

Chupete





Une con una flecha el objeto y su nombre

Camgrajo

Corona

Barco

Perro

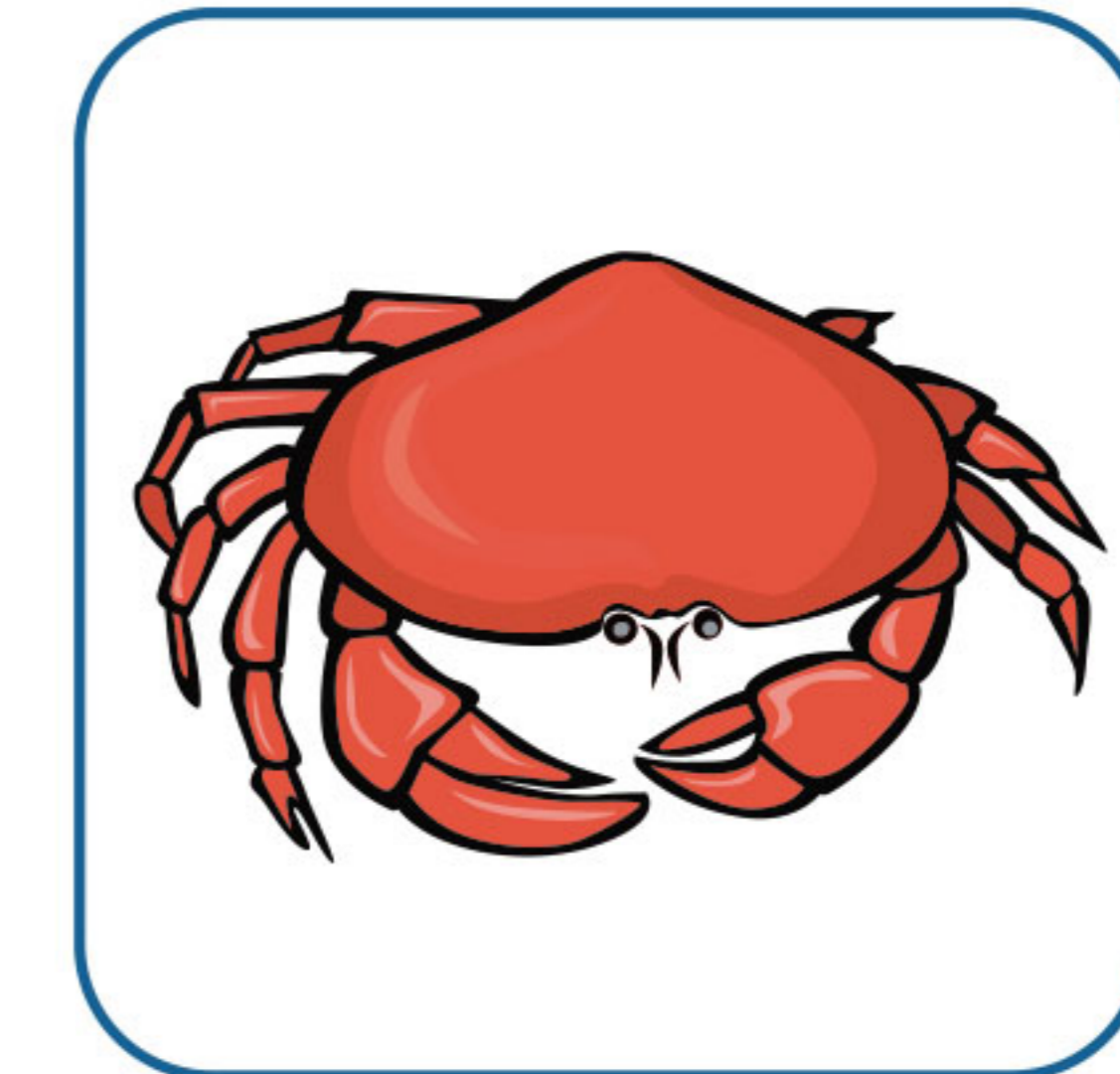

Une con una flecha el objeto y su nombre

Cohete

Robot

Sonajero

Delfín

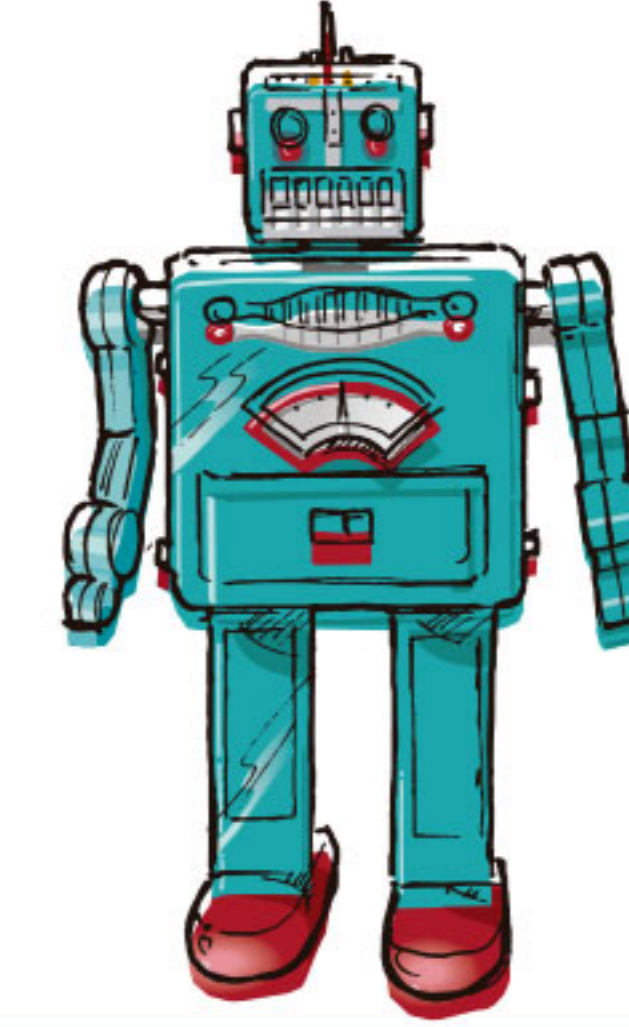

FICHAS DE

# CÁLCULO

---

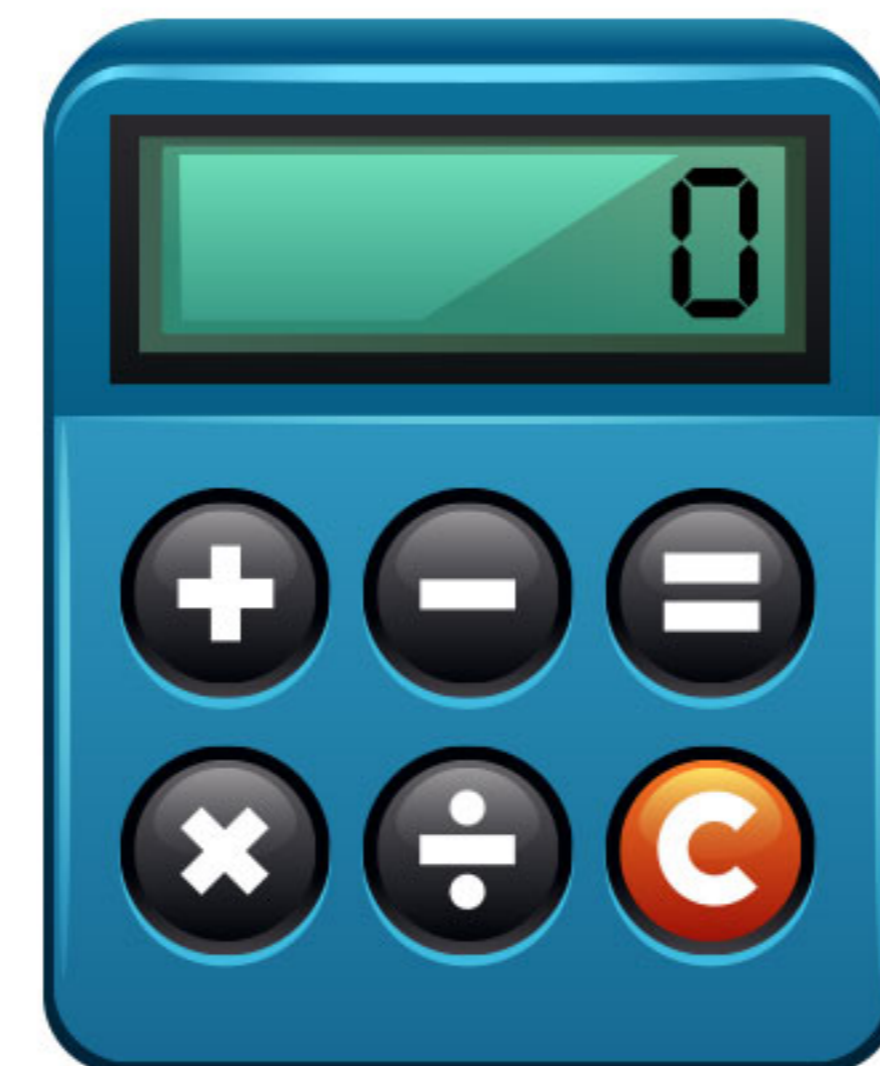

Escribe el resultado de las cuentas en el círculo vacío.

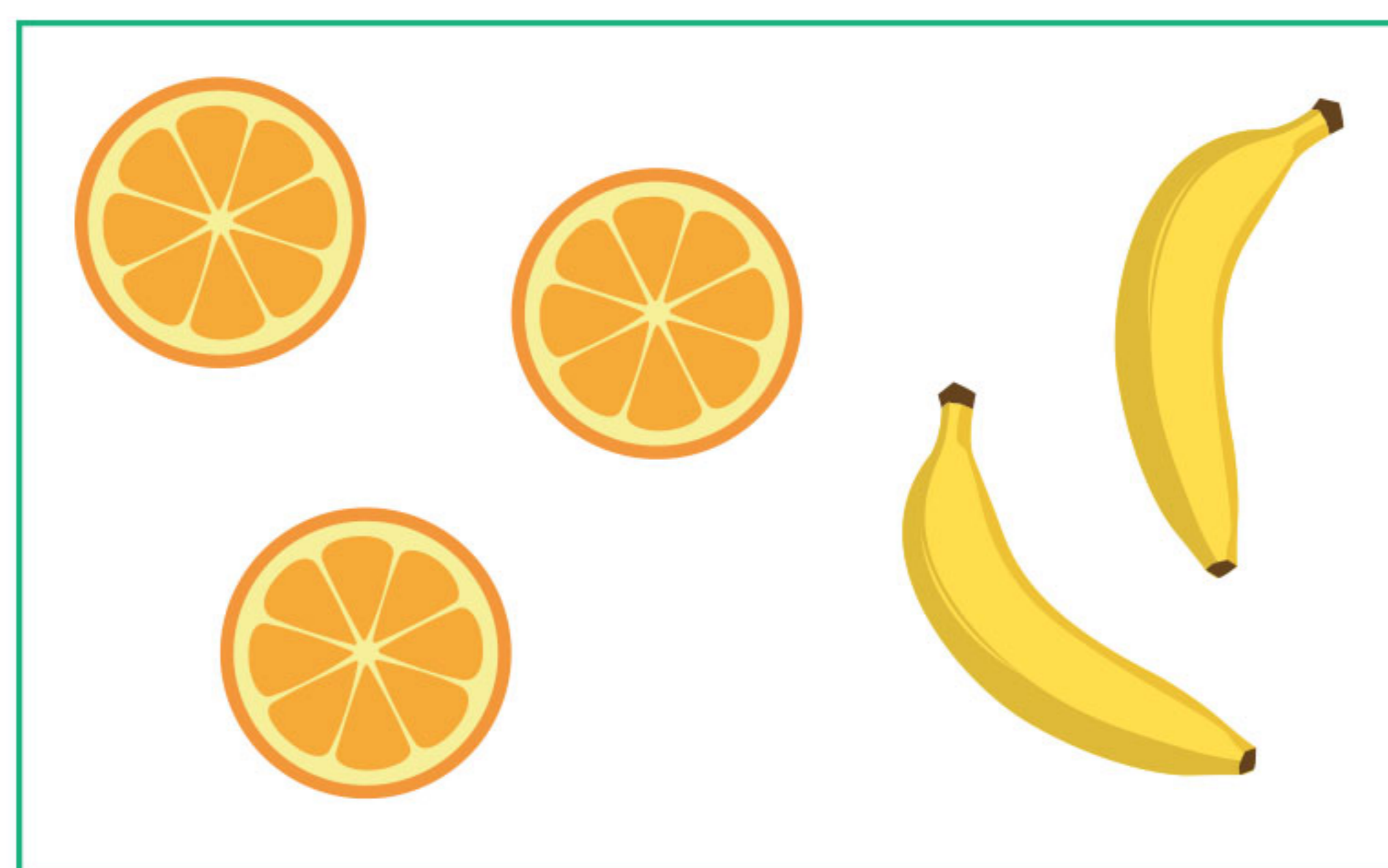

$$3 + 2 = \bigcirc$$



$$4 - 1 = \bigcirc$$



$$5 + 2 = \bigcirc$$

Escribe el resultado de las cuentas en el círculo vacío.

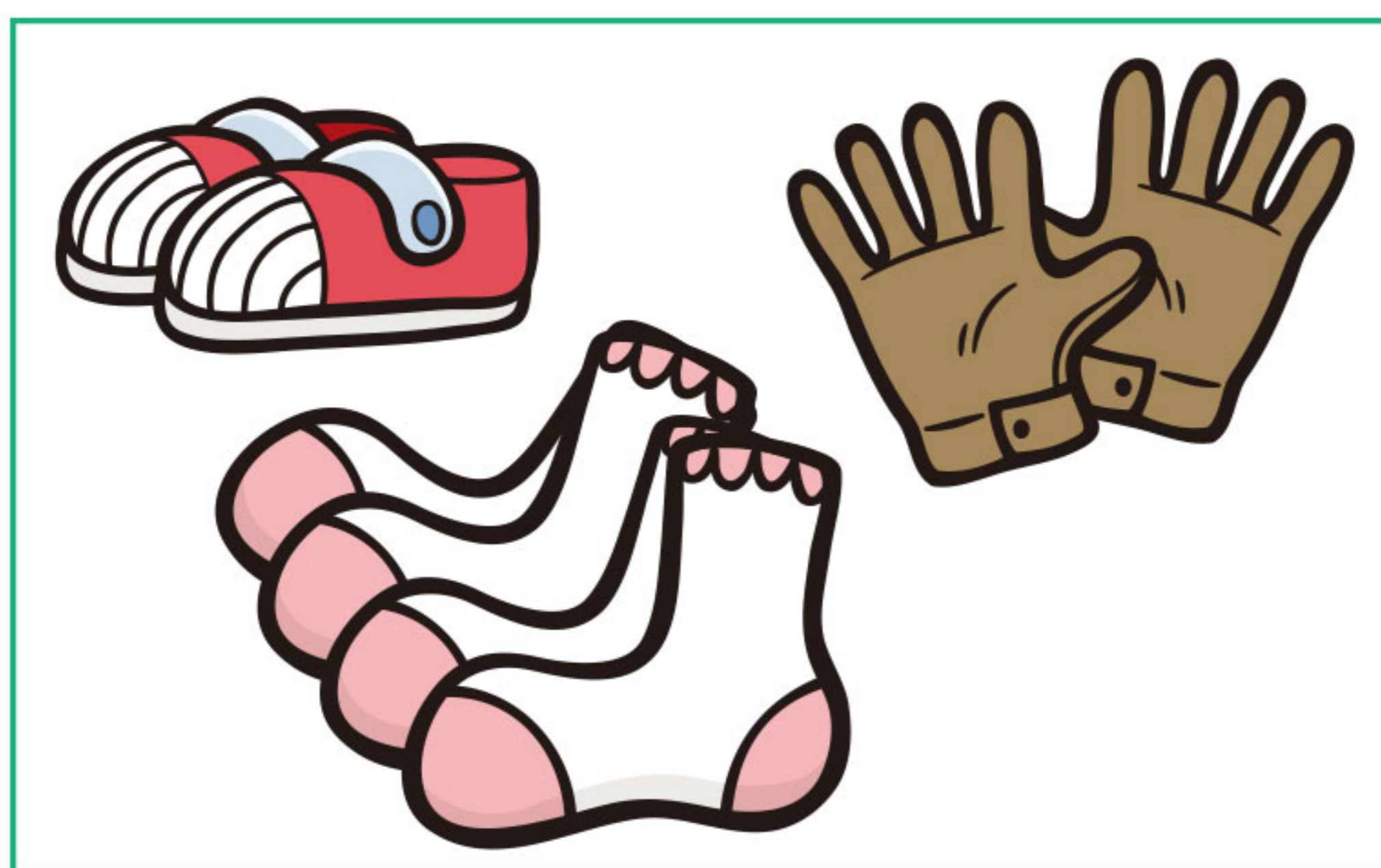

$$4 + \quad + 2 = 8$$

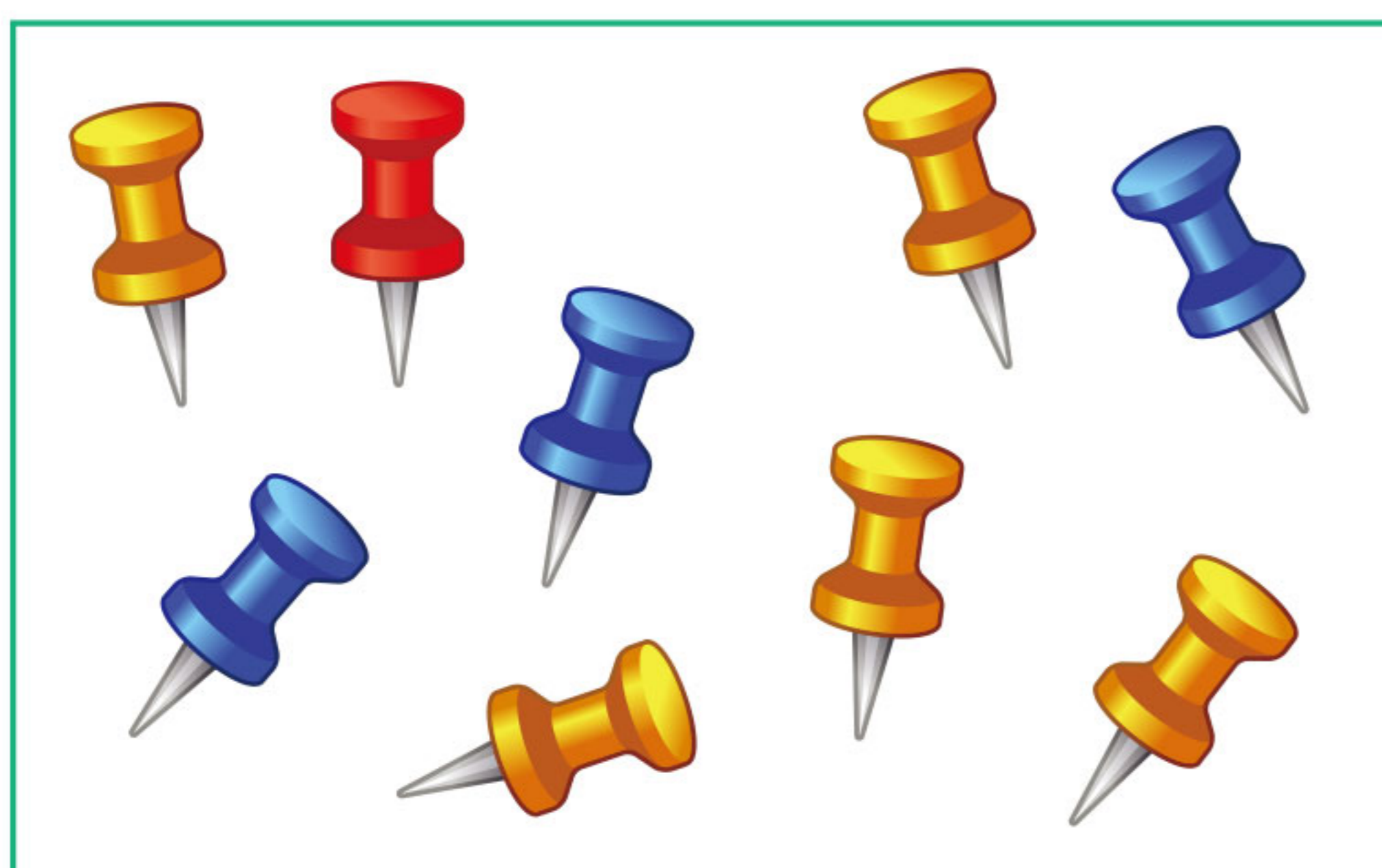

$$1 + 3 + \quad = 9$$



$$9 - 2 = \quad$$

$$\begin{array}{r} + 5 \\ 2 \\ \hline \end{array}$$

$$\begin{array}{r} + 4 \\ 1 \\ \hline \end{array}$$

$$\begin{array}{r} + 3 \\ 2 \\ \hline \end{array}$$

$$\begin{array}{r} 8 \\ - 2 \\ \hline \end{array}$$

$$\begin{array}{r} 9 \\ - 1 \\ \hline \end{array}$$

$$\begin{array}{r} 3 \\ - 3 \\ \hline \end{array}$$

$$\begin{array}{r} + 1 \\ 2 \\ \hline \end{array}$$

$$\begin{array}{r} + 1 \\ 1 \\ \hline \end{array}$$

$$\begin{array}{r} + 2 \\ 2 \\ \hline \end{array}$$

$$\begin{array}{r} 4 \\ - 2 \\ \hline \end{array}$$

$$\begin{array}{r} 3 \\ - 1 \\ \hline \end{array}$$

$$\begin{array}{r} 2 \\ - 1 \\ \hline \end{array}$$

Rodea el conjunto de objetos que representa la suma

$$5 + 2 = 7$$

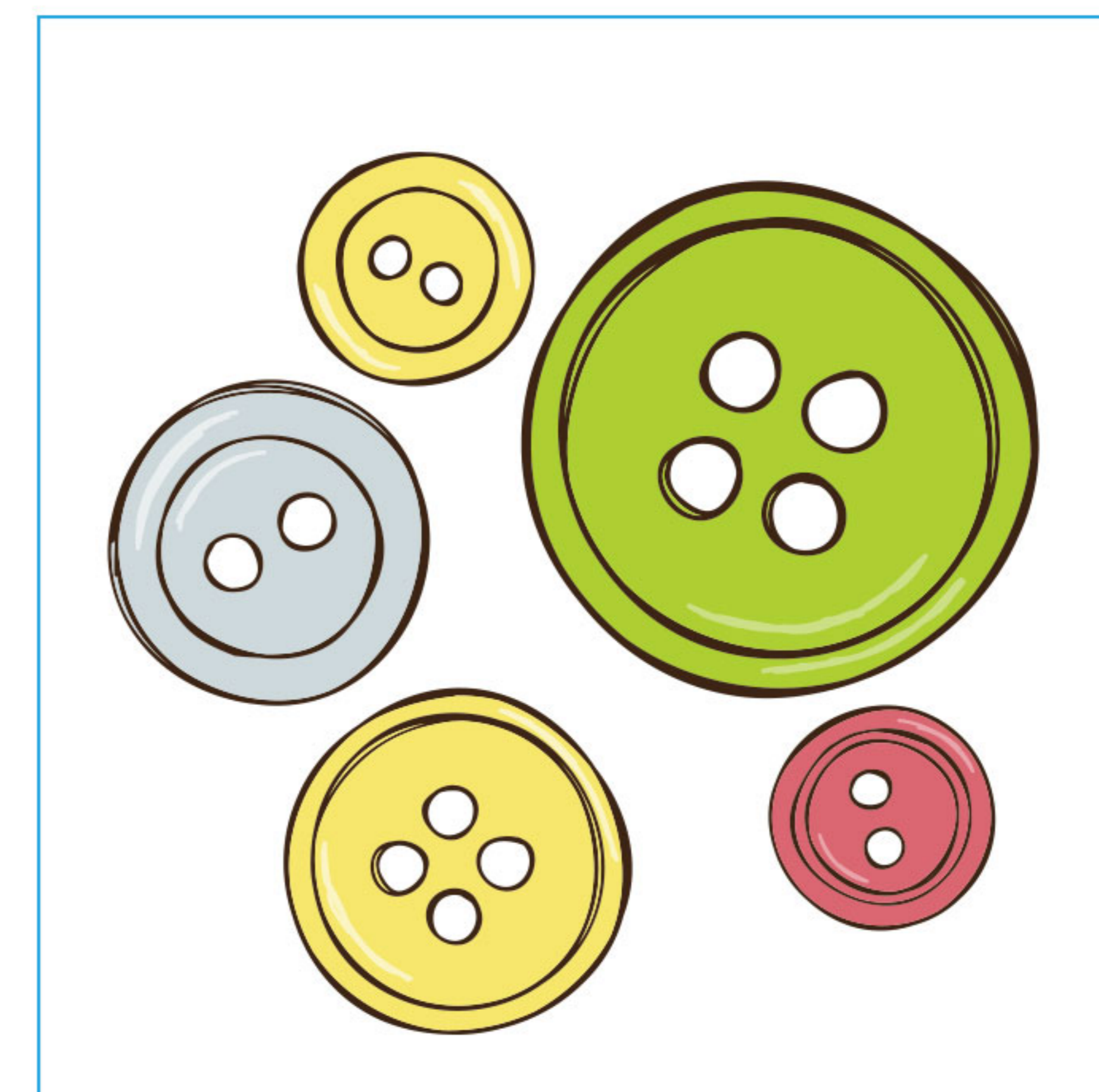



Rodea el conjunto de objetos que representa la suma

$$3 + 3 = 6$$

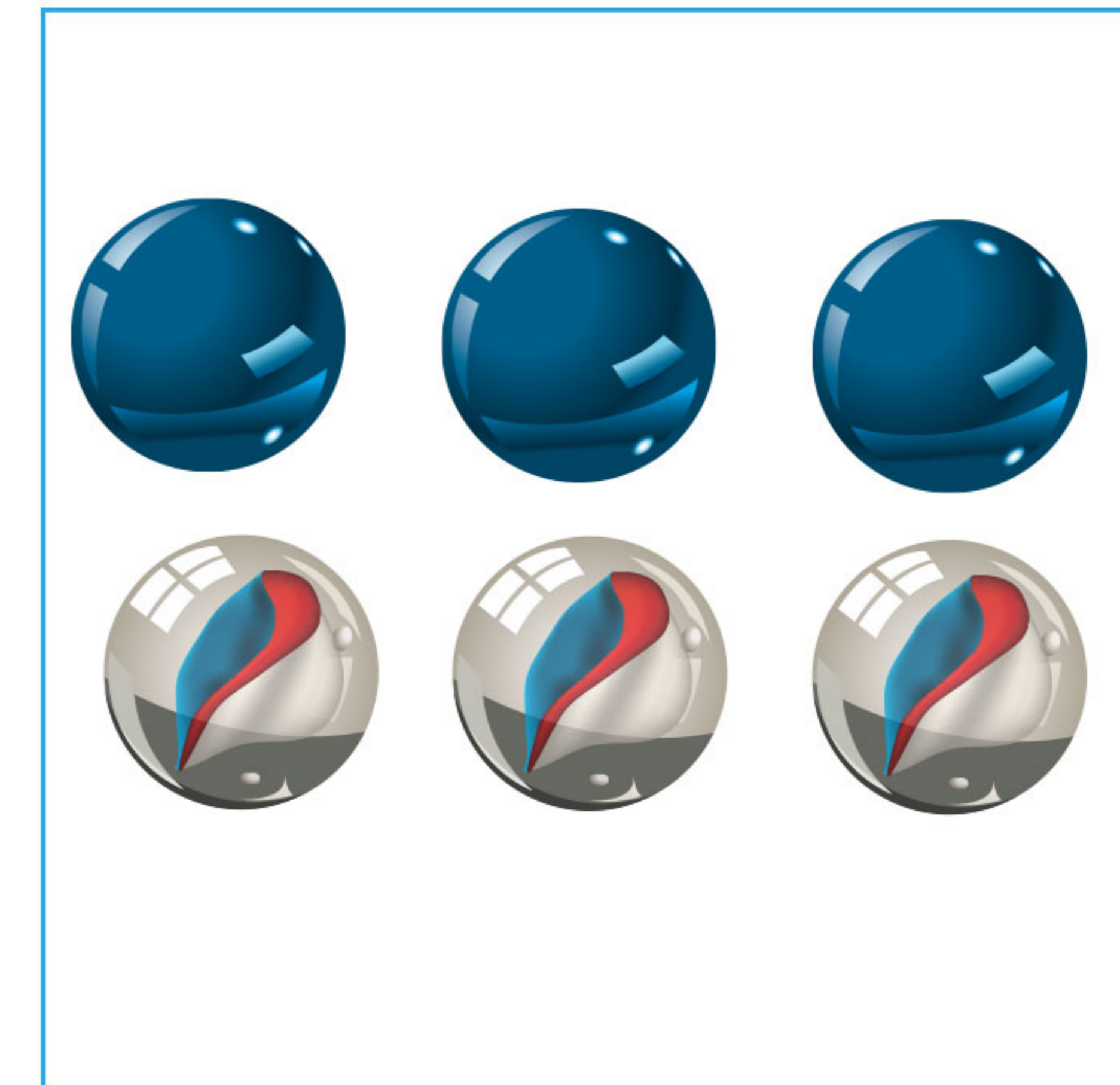
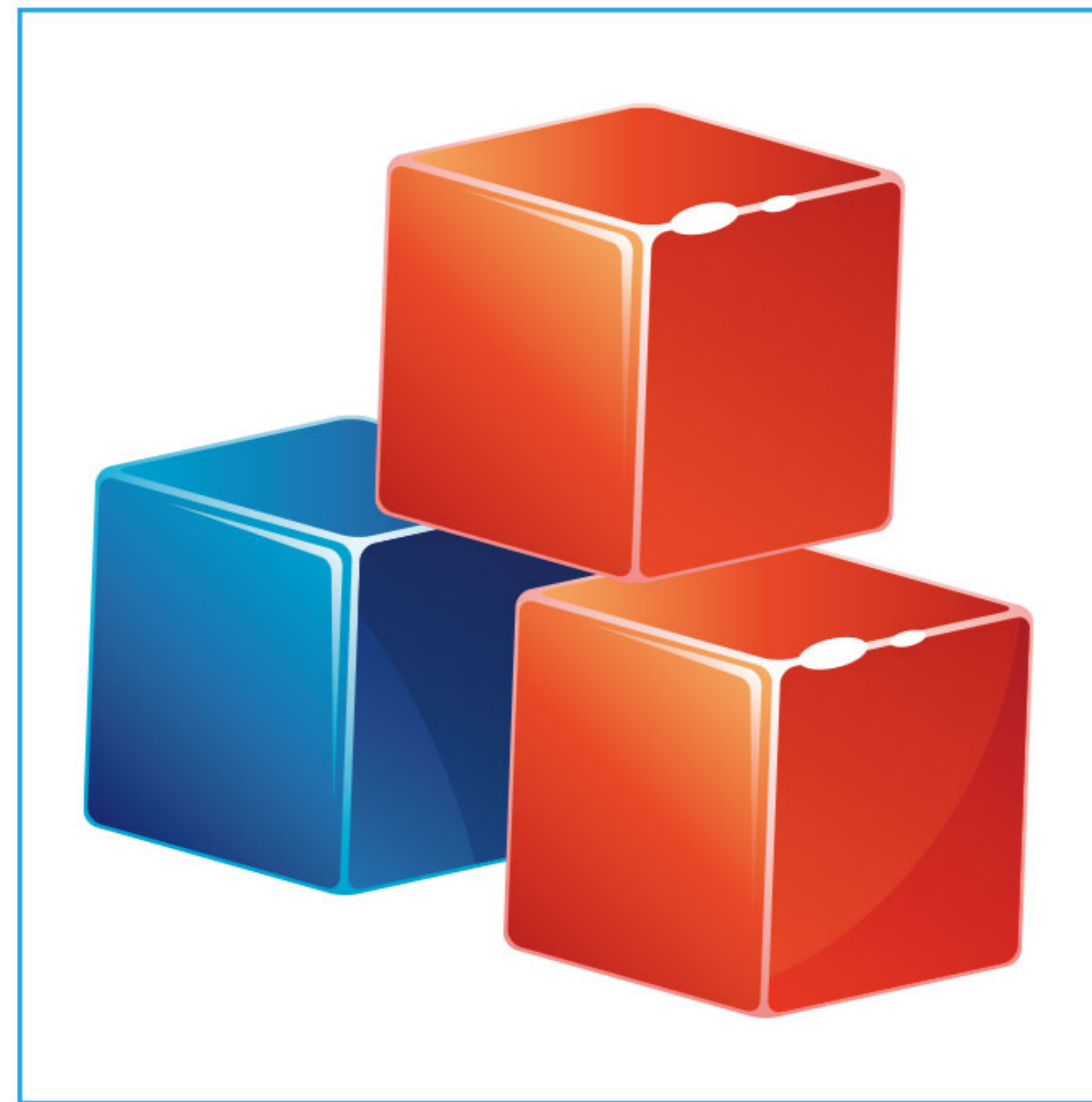

Rodea el conjunto de objetos que representa la suma

$$1 + 1 = 2$$

