



TRAZAMOS

LAS

LETRAS

ACLARACIONES. :

- La **x** minúscula no la hagáis porque cuando escribimos nosotros la trazamos como la X mayúscula.
- La **V** mayúscula, la hacemos al revés. 1º trazamos el vértice que baja y después el vértice que sube.
- La **T** mayúscula, 1º hacemos el trazo vertical descendente y después el trazo horizontal izquierda-derecha.
- La **p** minúscula, 1º trazamos el palote hacia abajo y después el tobogán.
- La **M, N, Ñ** se puede hacer como está indicado o el primer trazo hacerlo descendente en lugar de ascendente.
- Colorear las letras de la portada.

- *Mirar posición de espalda al escribir, posición de lápiz y trazo.*

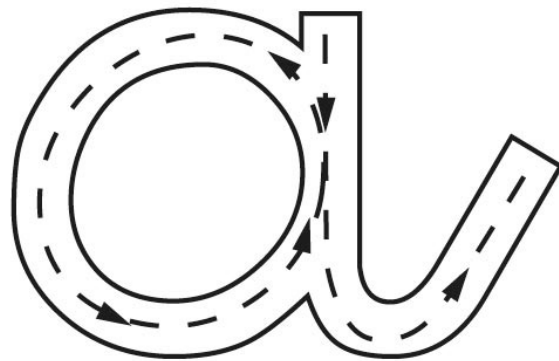
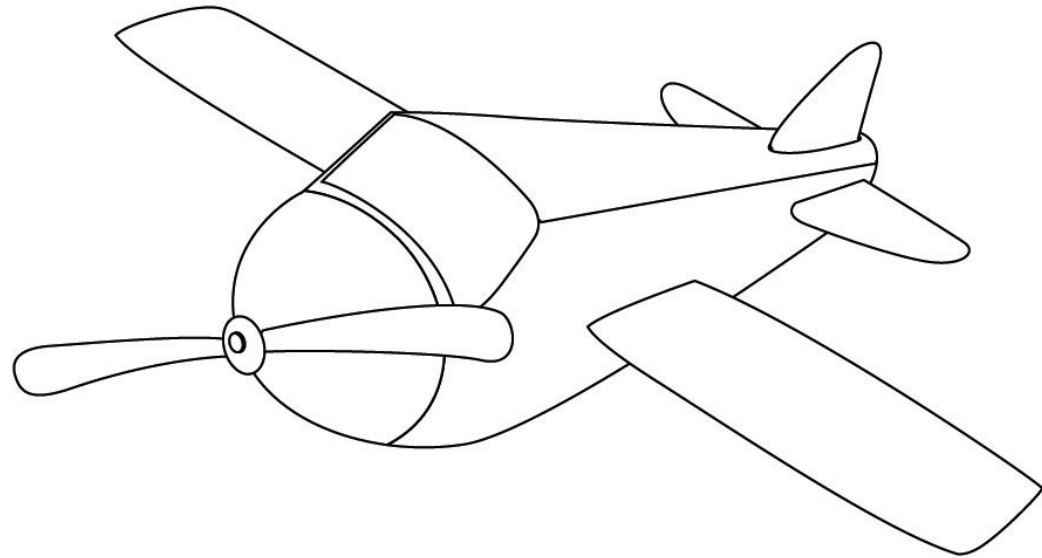
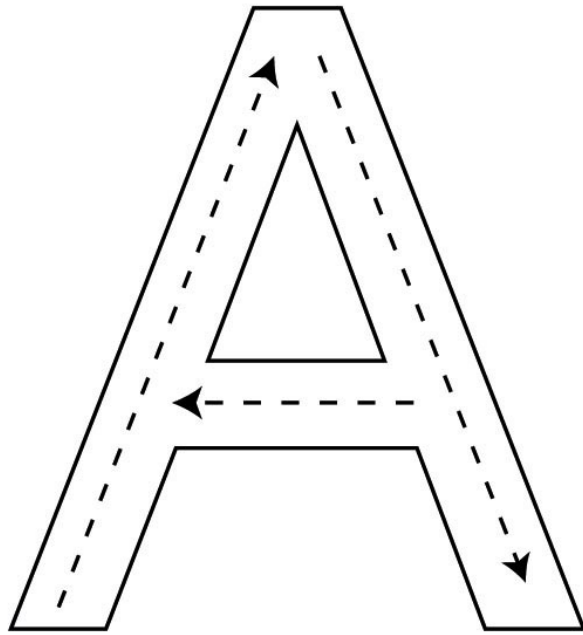

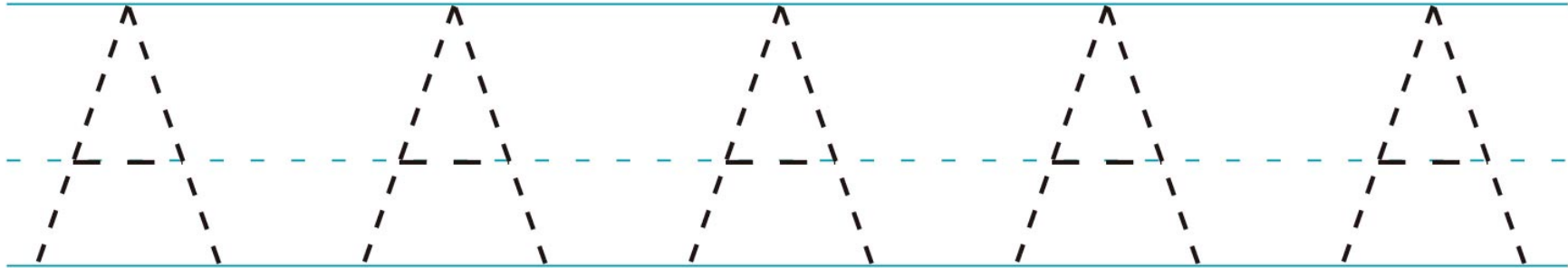
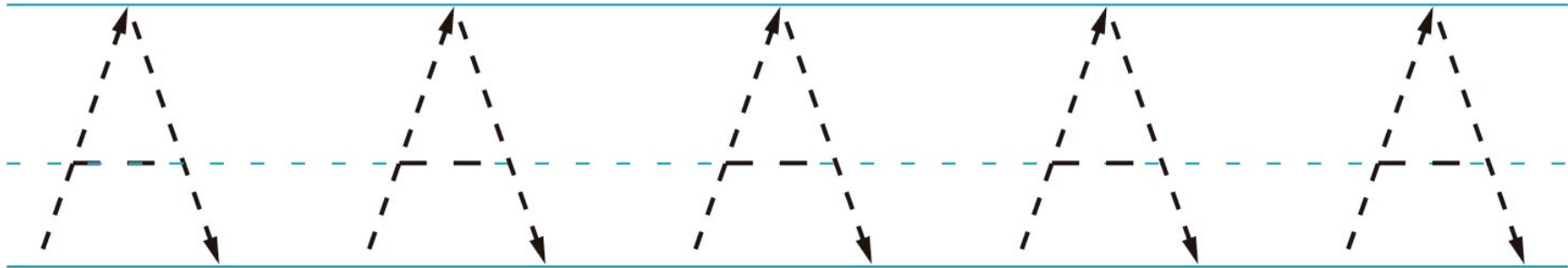
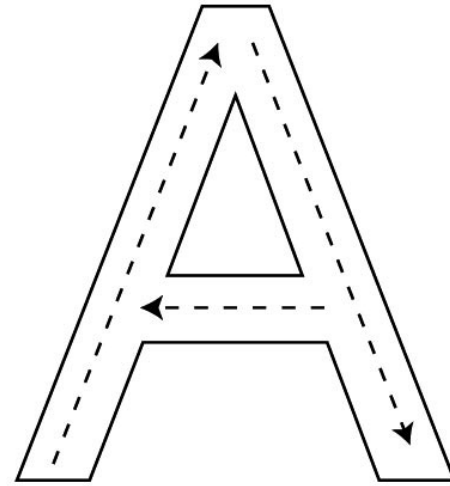
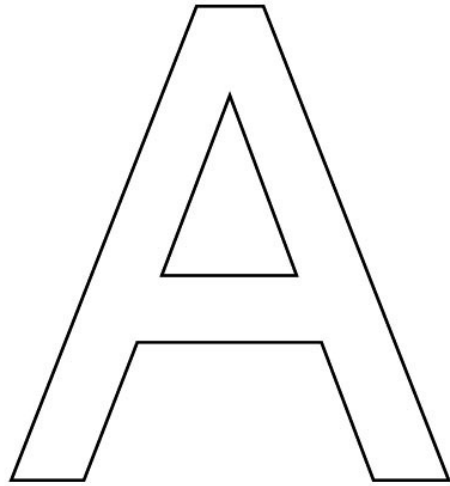

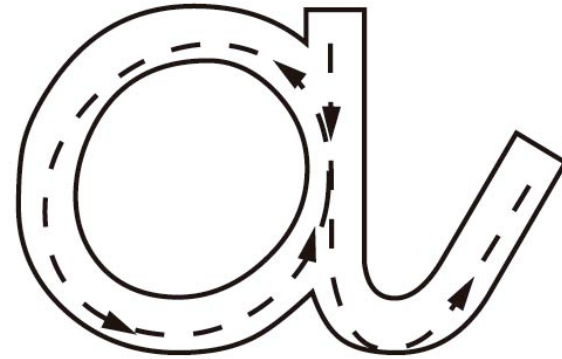

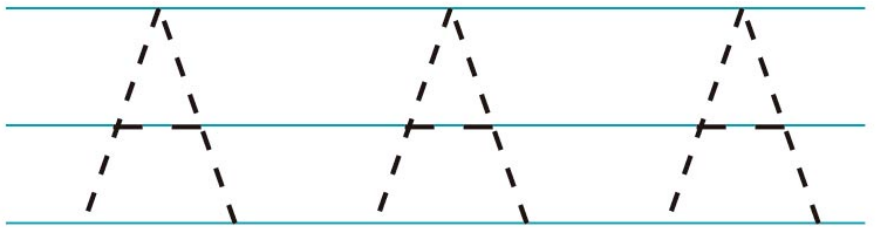
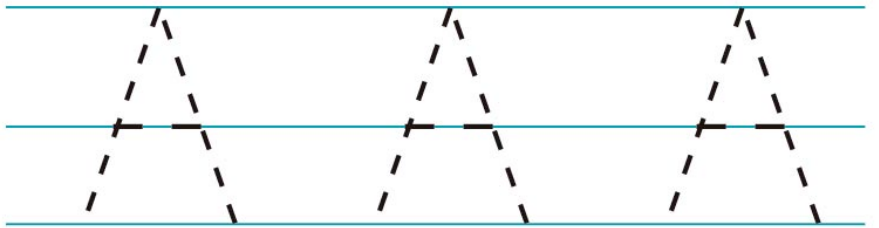
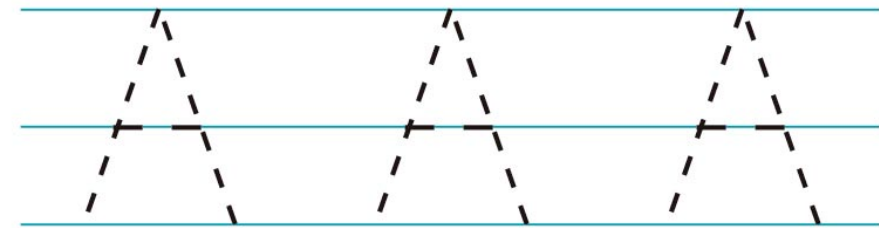
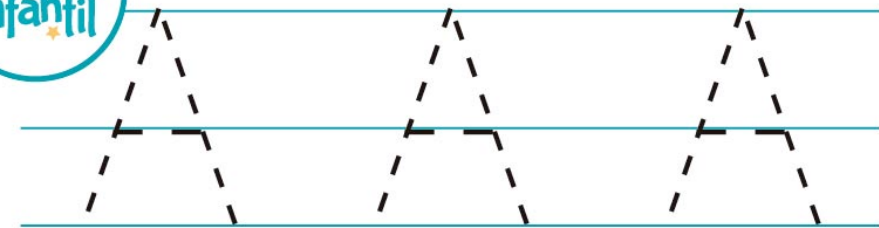

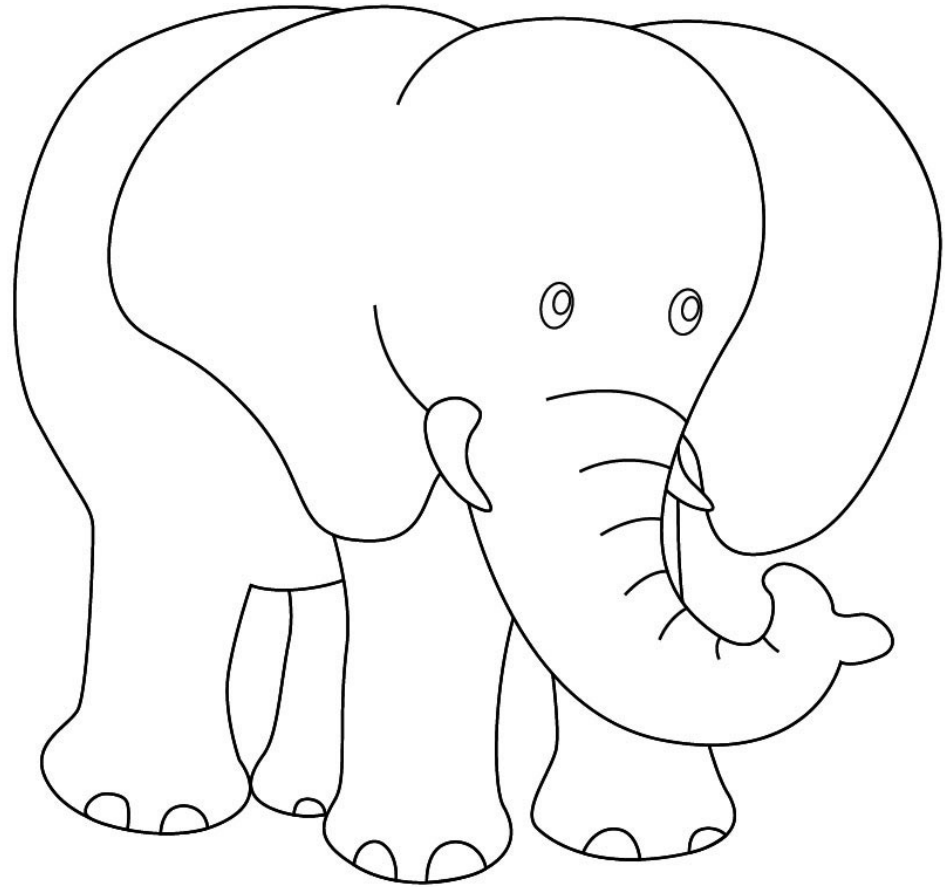
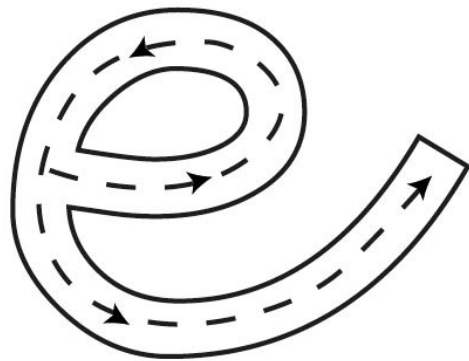
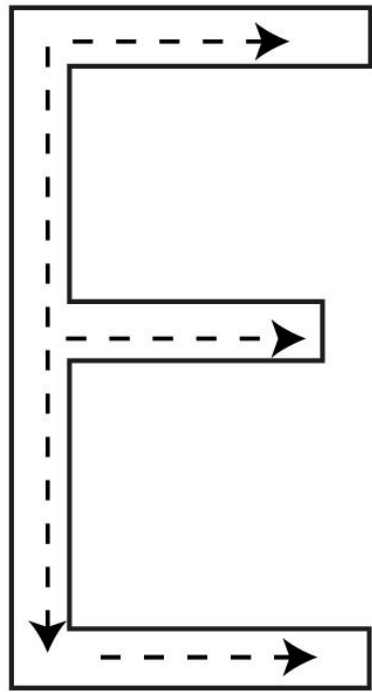

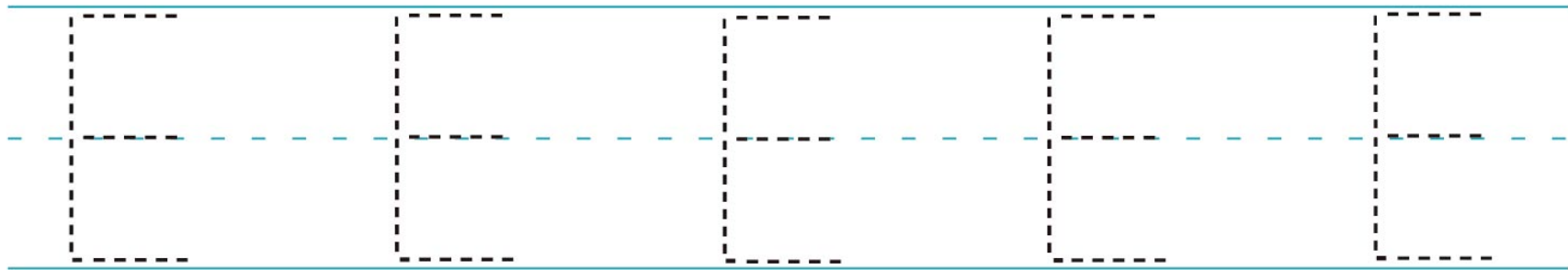
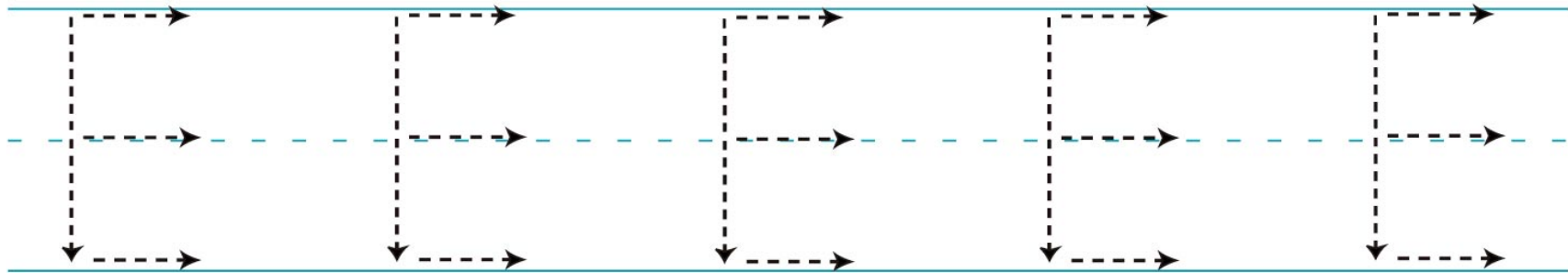
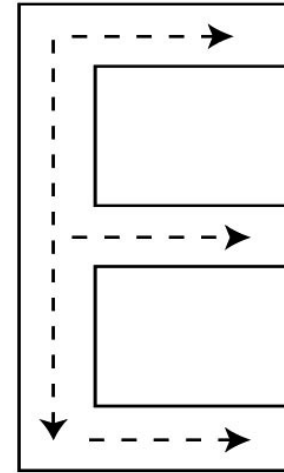
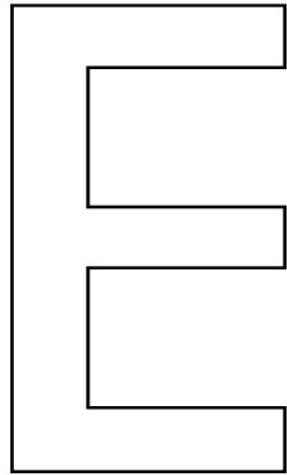

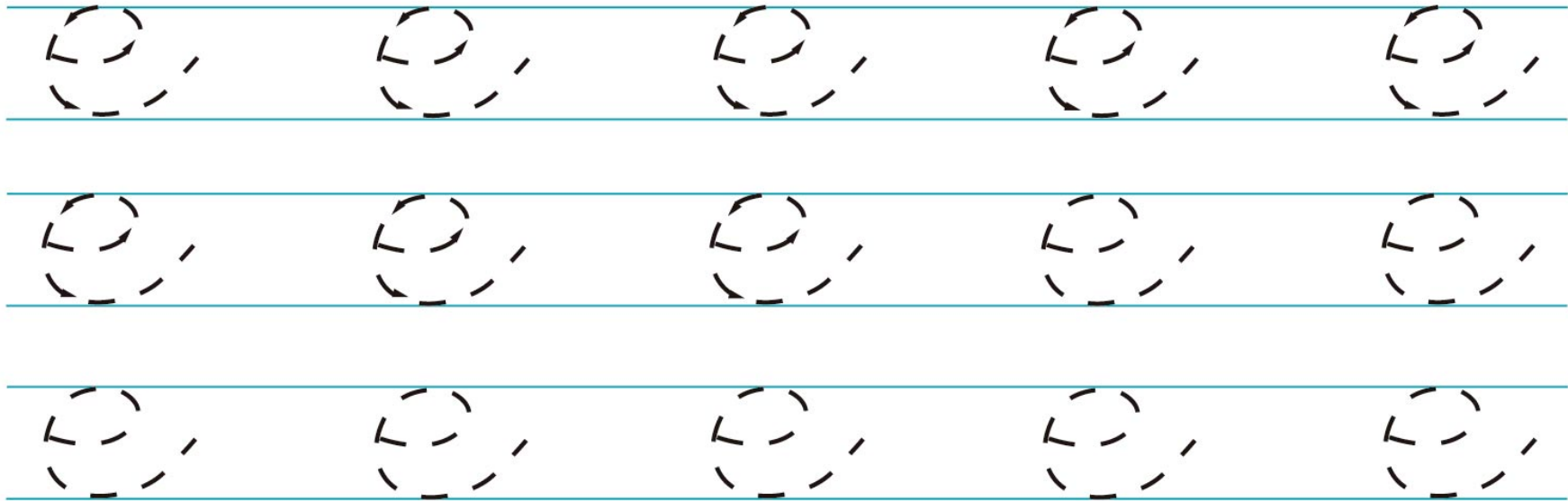
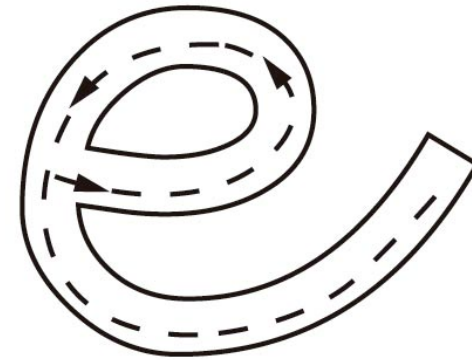
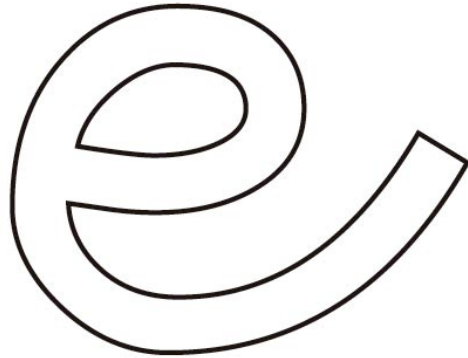

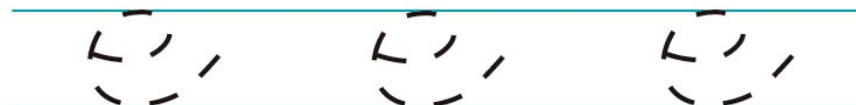
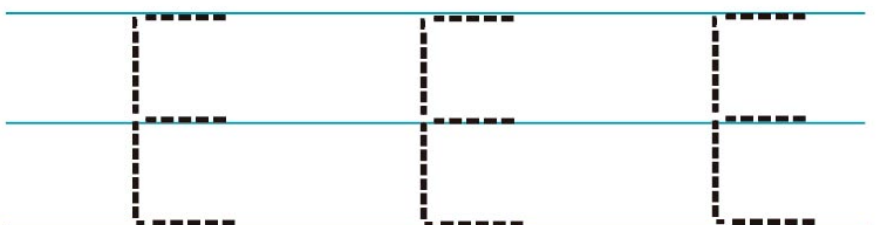
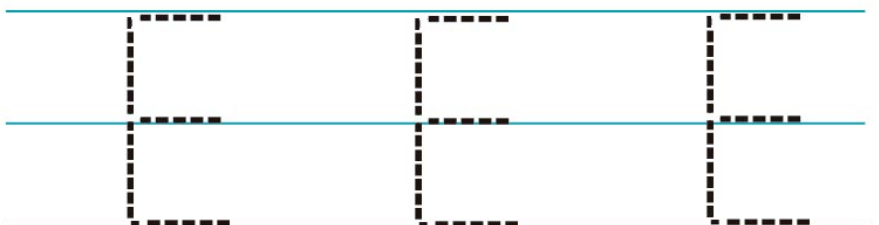
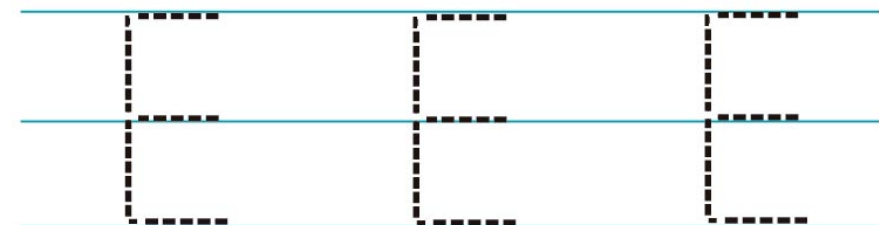
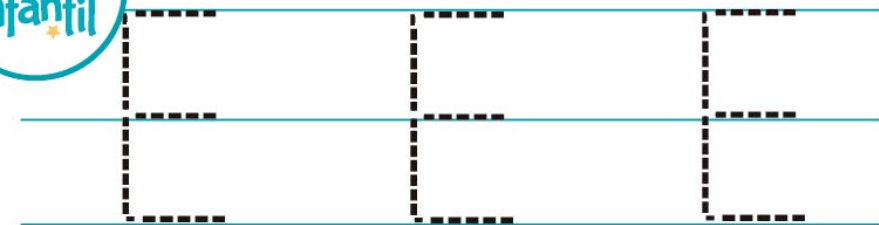

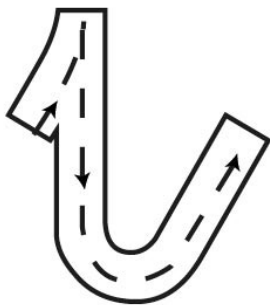
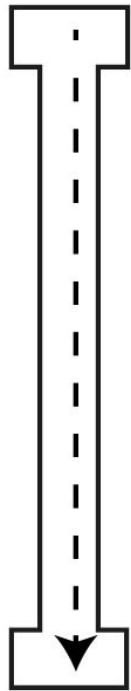

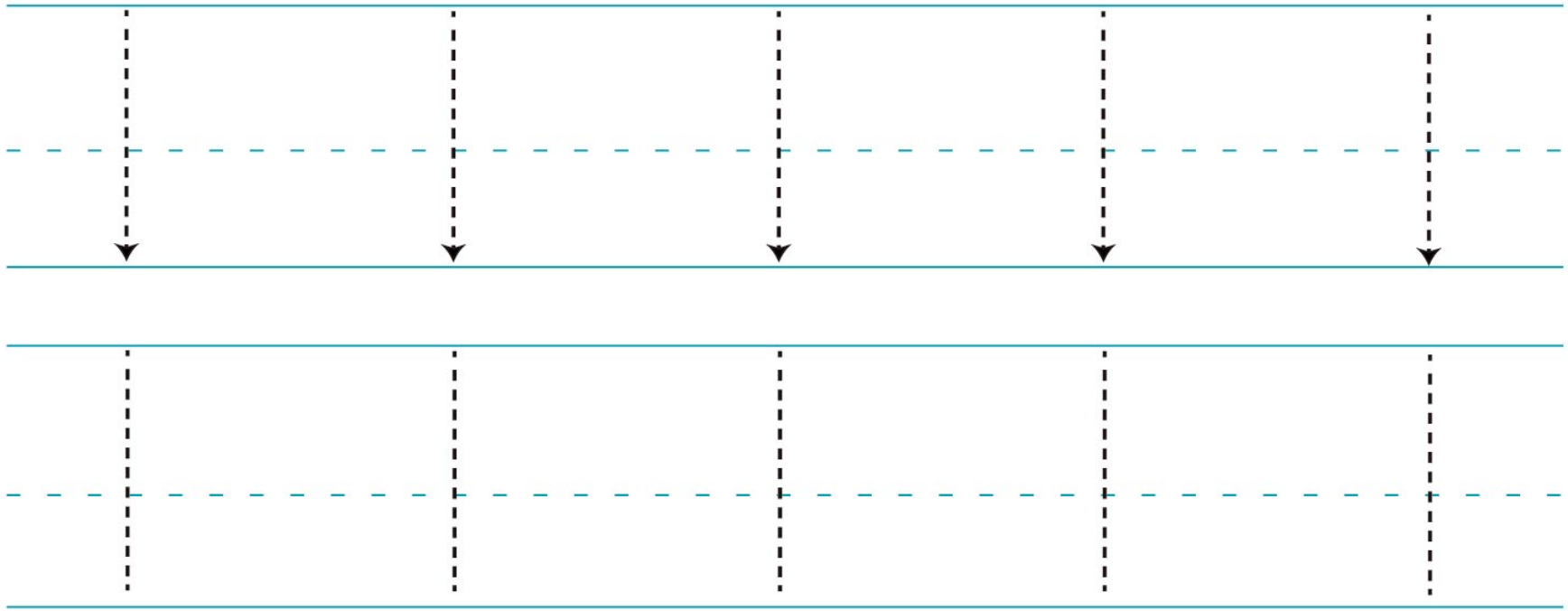
The page features two sets of handwriting practice lines. Each set consists of three horizontal lines: a solid top line, a dashed middle line, and a solid bottom line. Five vertical dashed lines are placed between the top and bottom solid lines of each set, with a small black arrowhead at the bottom of each line, indicating the downward direction of the stroke.

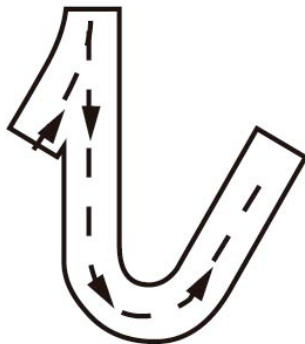
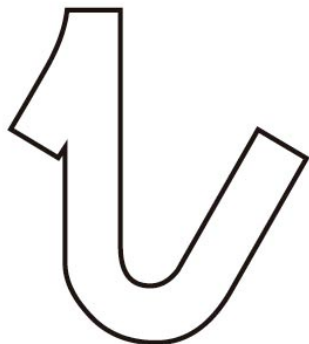

Tracing practice section with three rows of five dashed 'j' characters on lined paper. Each character has a solid dot above it. The first row shows the full stroke with arrows. The second row shows the stroke with arrows, but the top part is solid. The third row shows the stroke with arrows, but the top part is solid and the bottom part is dashed.

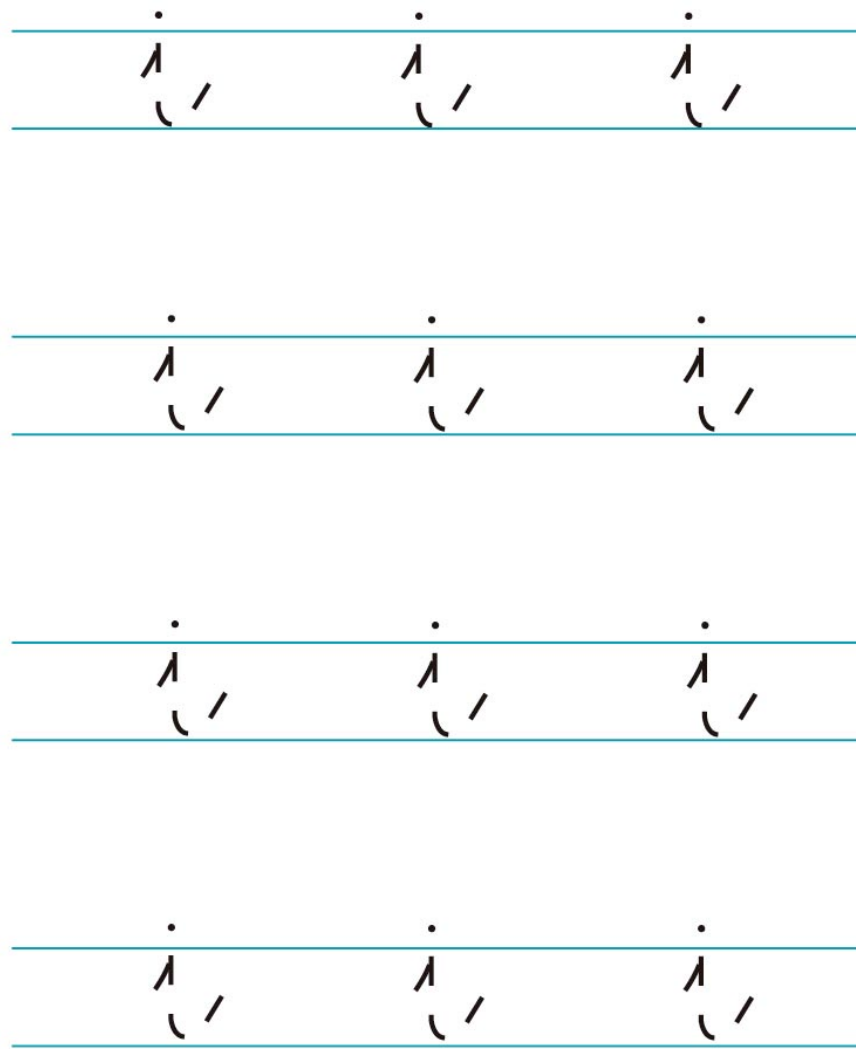
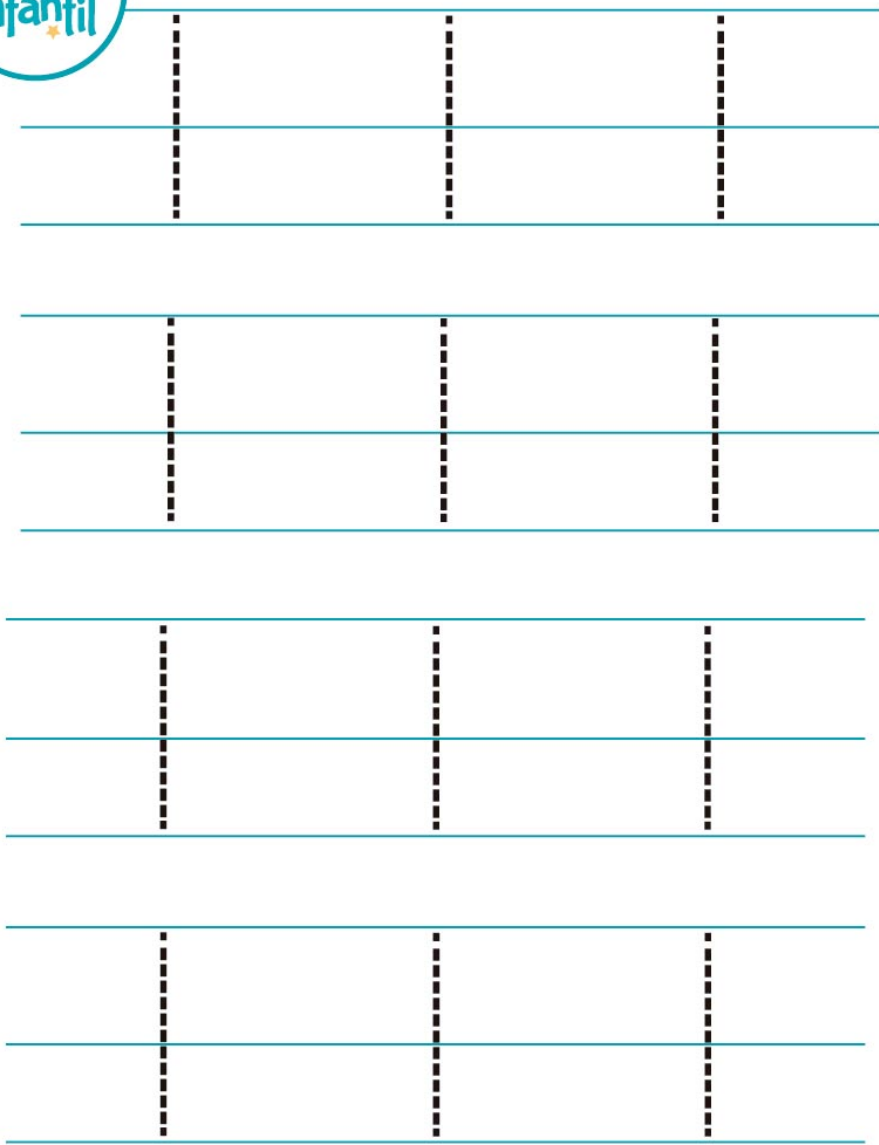

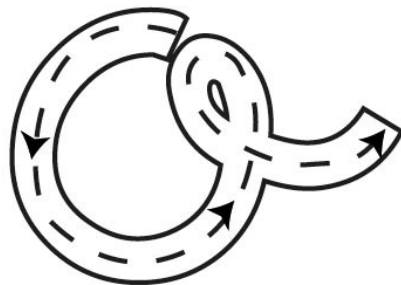
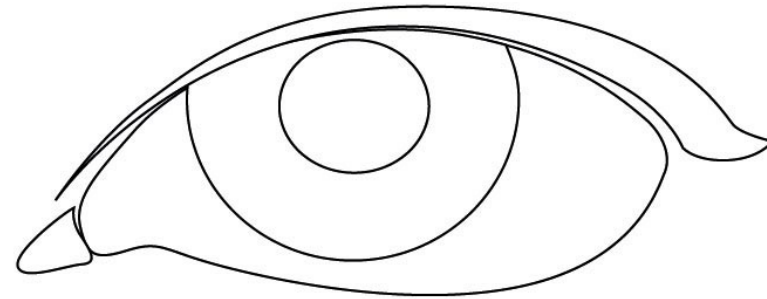
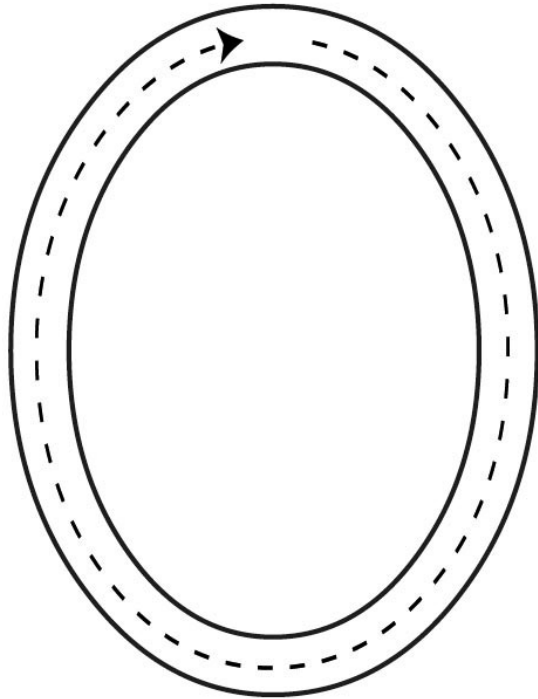

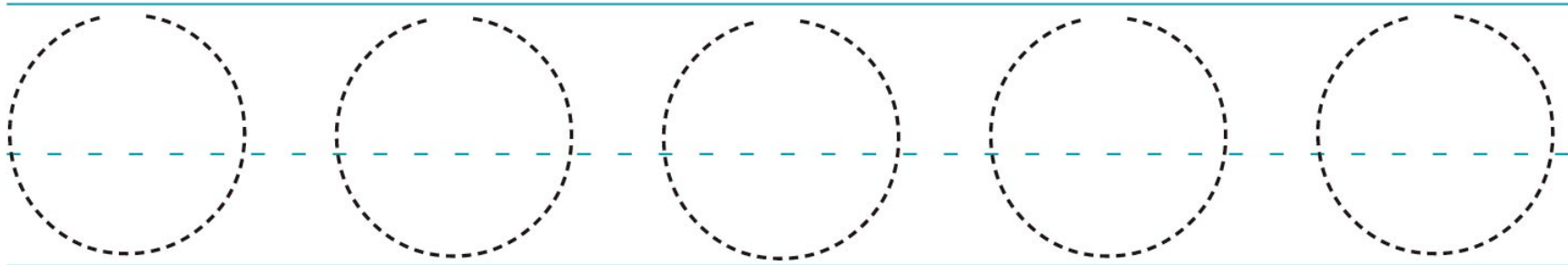
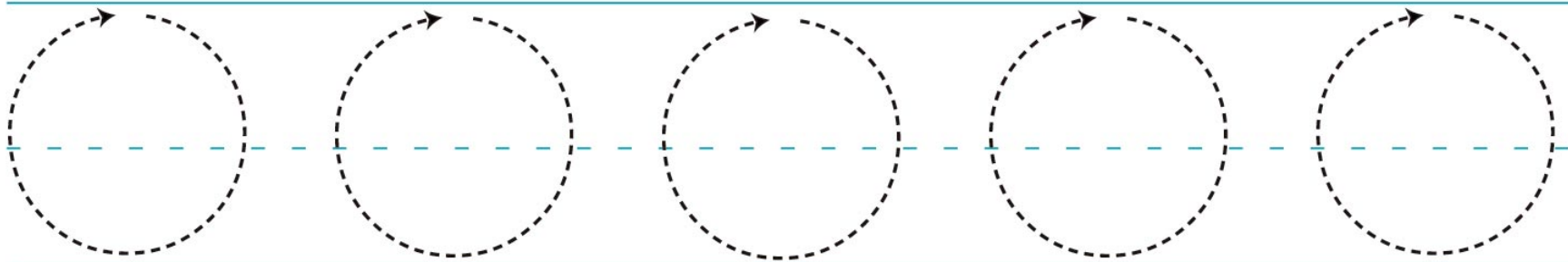
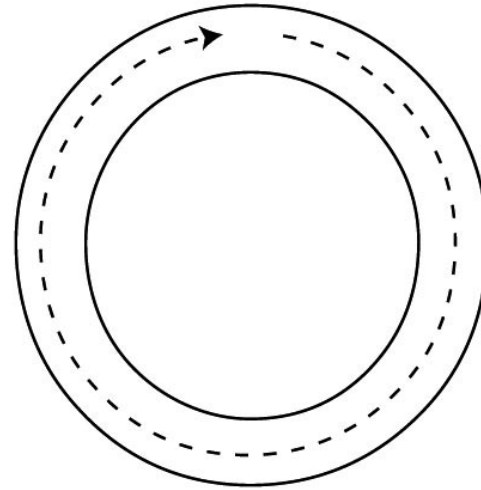
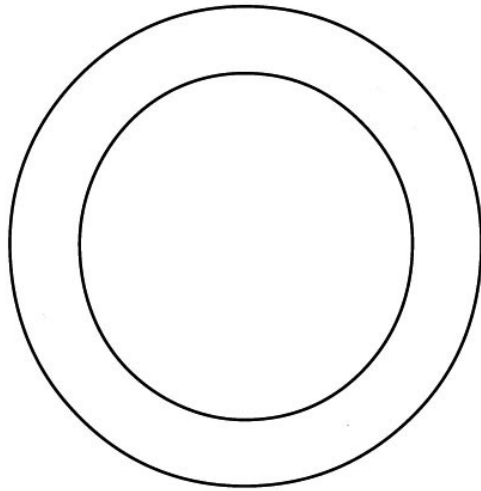

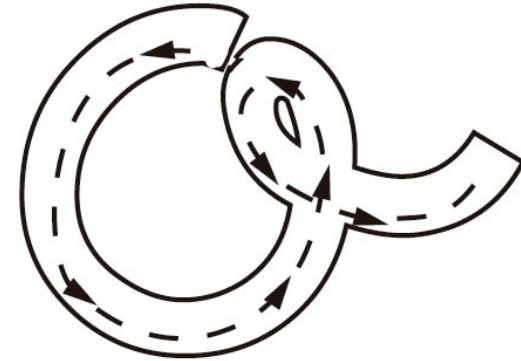
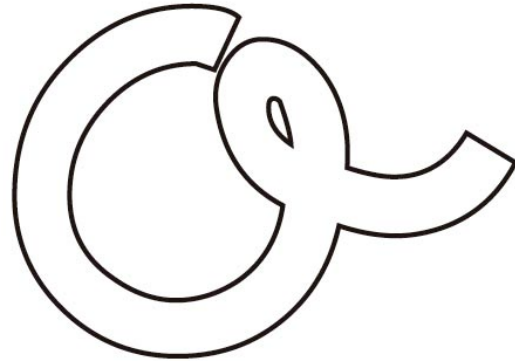

Tracing practice area consisting of three rows of five dashed 'e' characters on a four-line grid. The first row shows the full dashed 'e' with a small arrow indicating the starting point and direction. The second and third rows show the dashed 'e' without the starting arrow, for independent tracing practice.

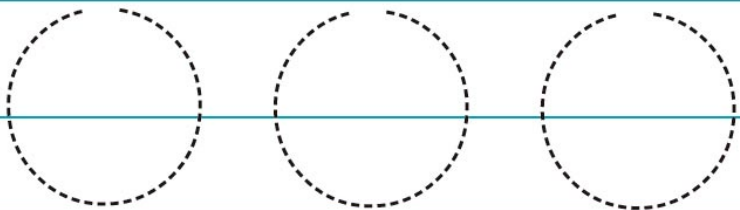
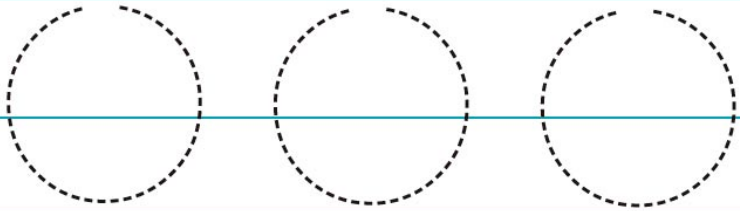
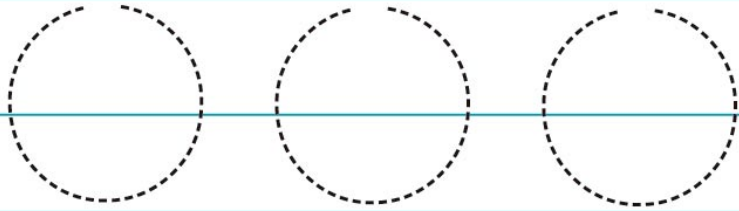
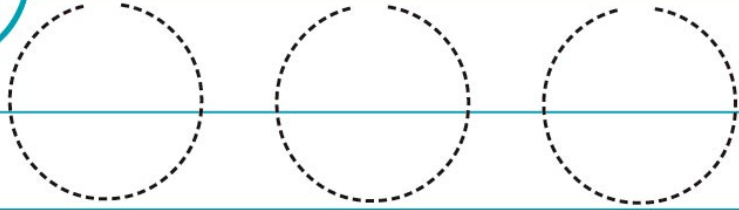

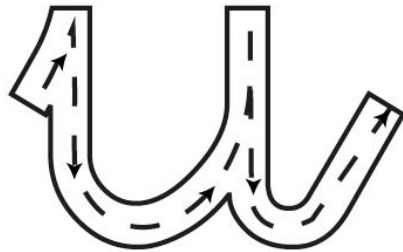
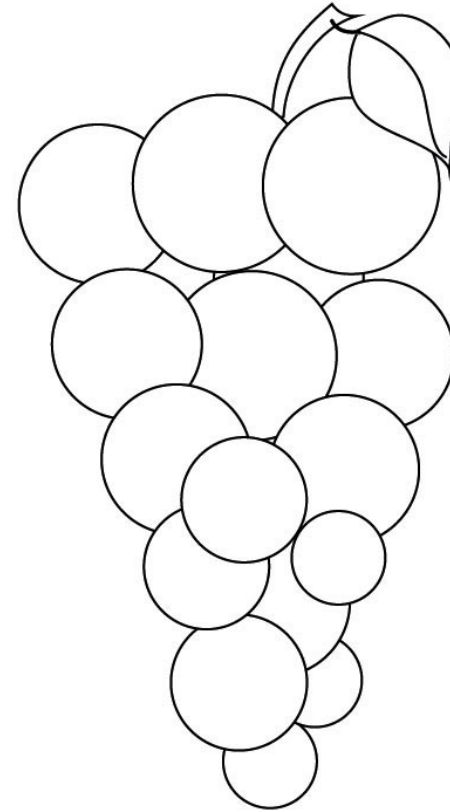
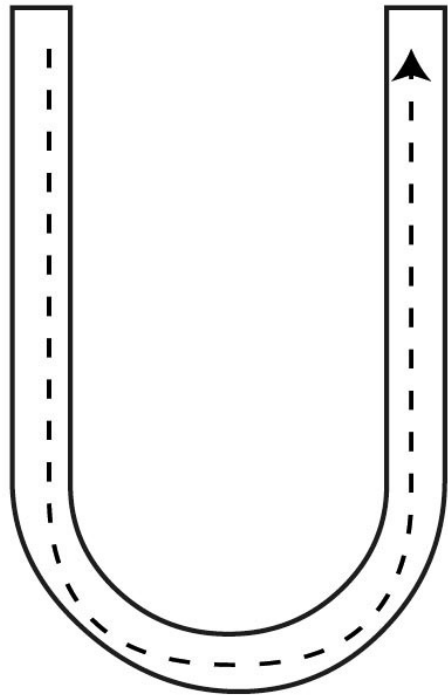

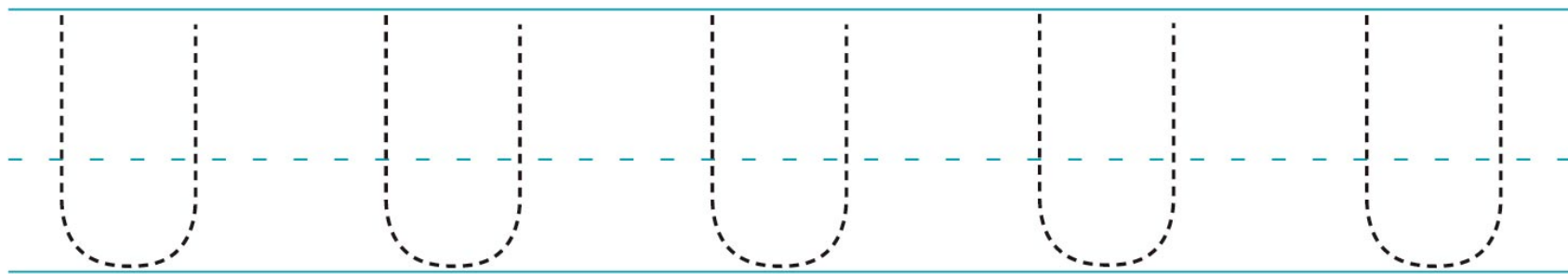
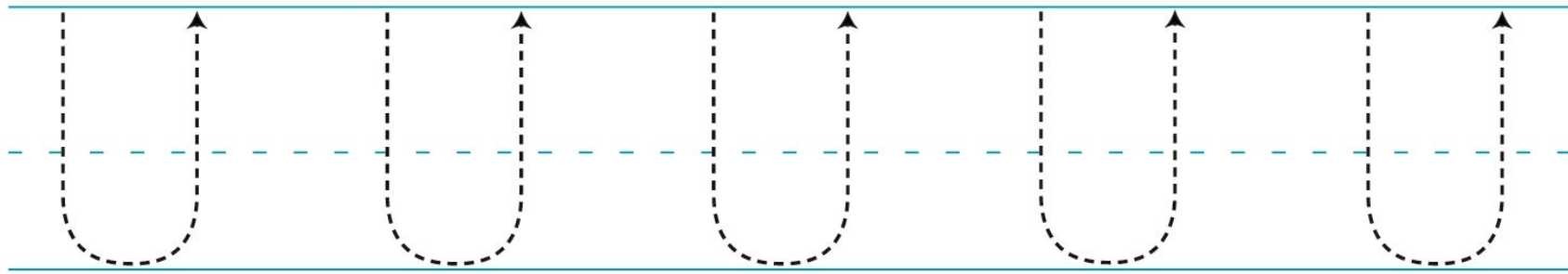
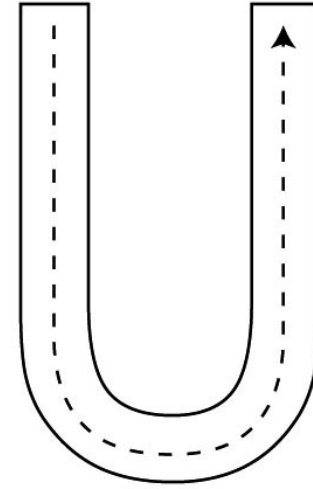
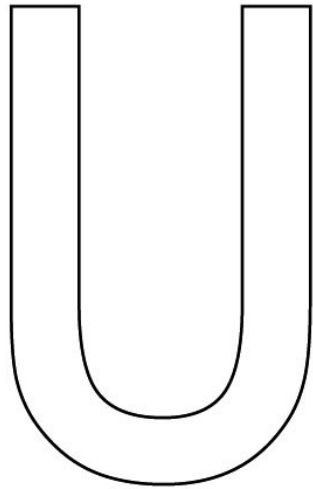

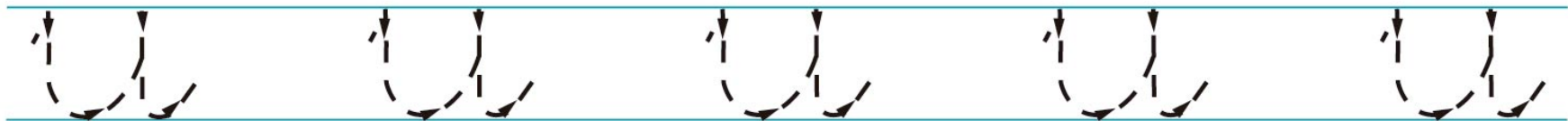
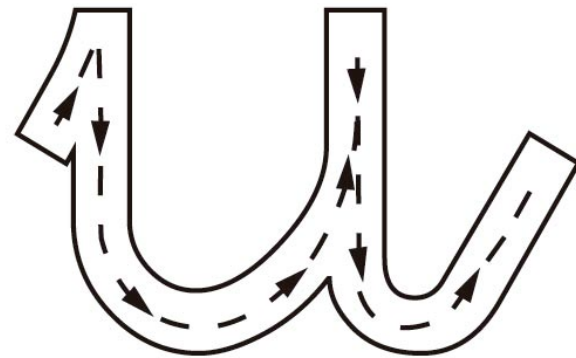
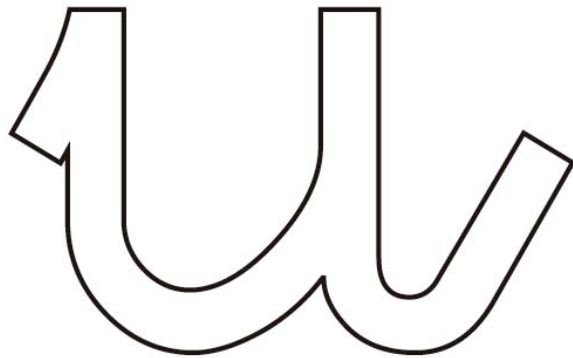

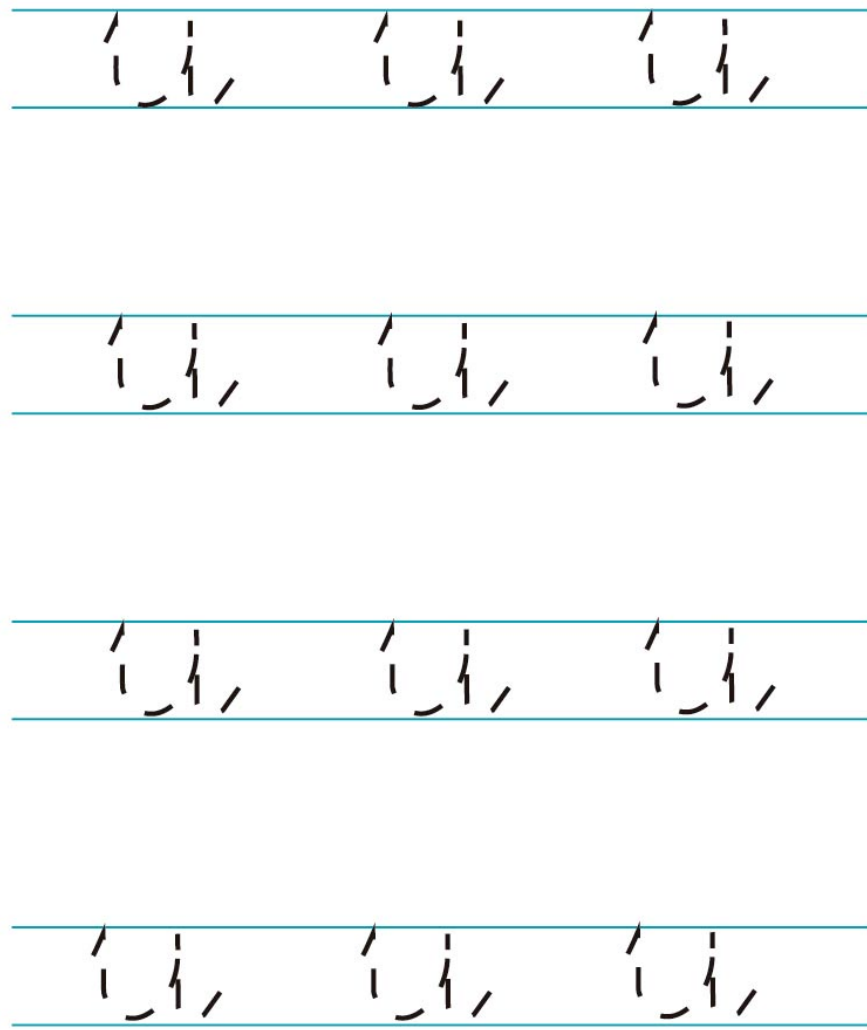
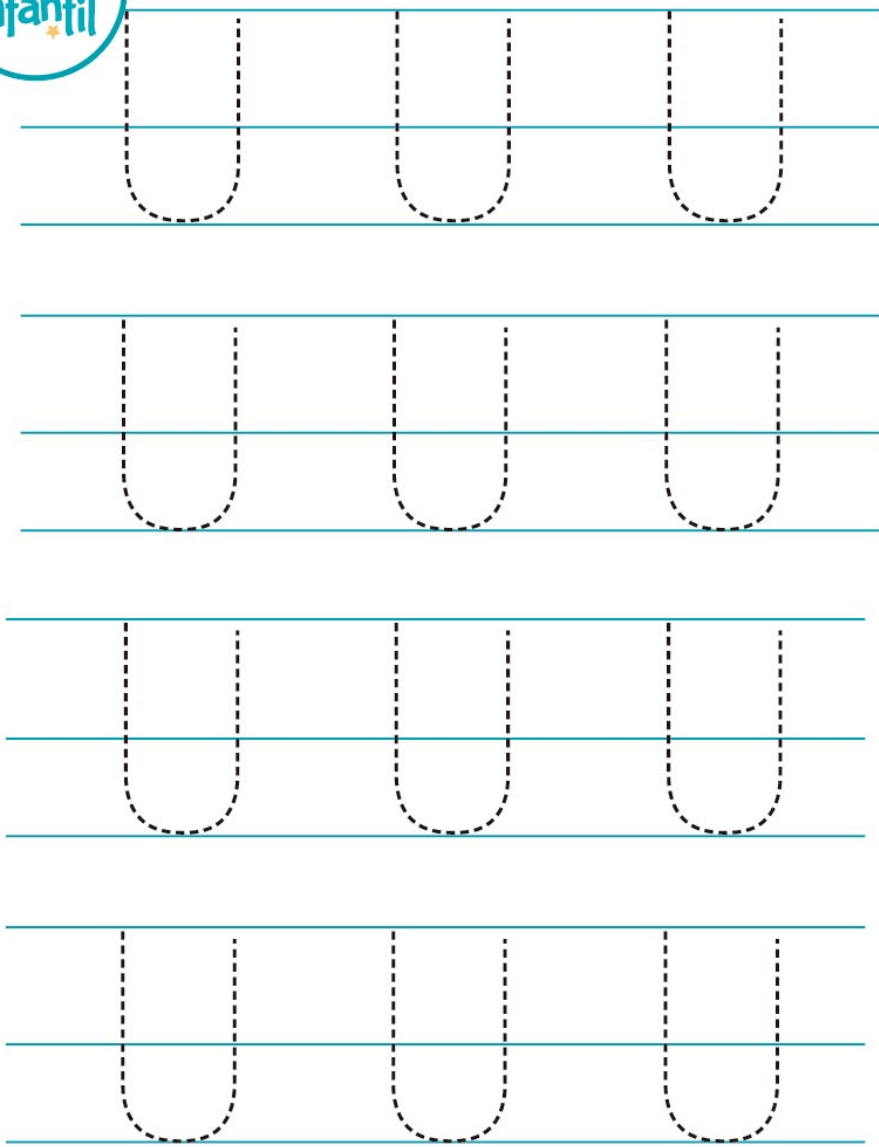

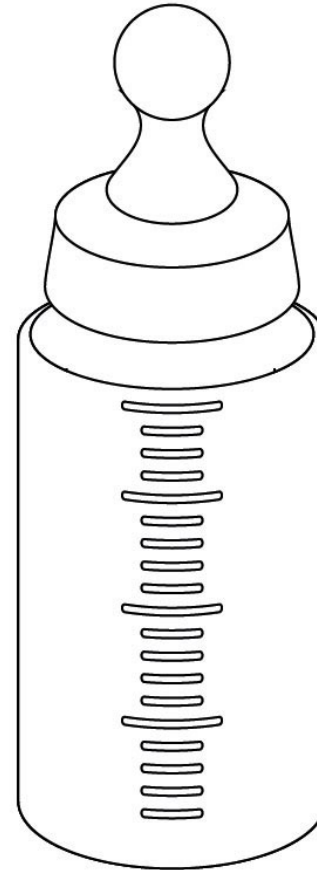
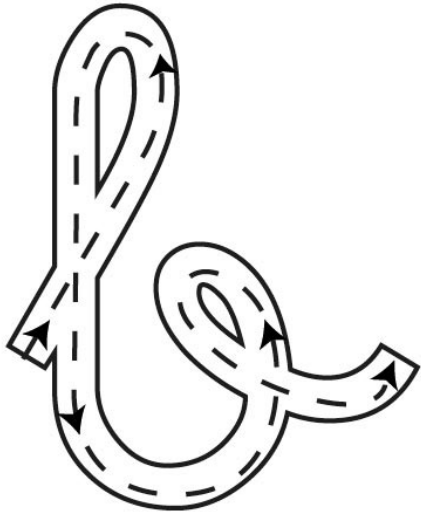
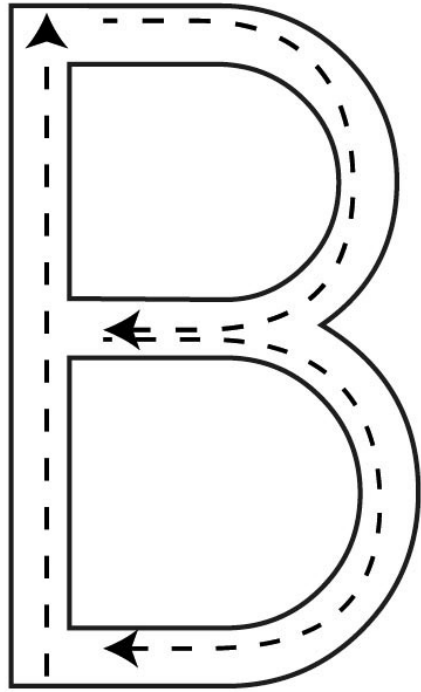

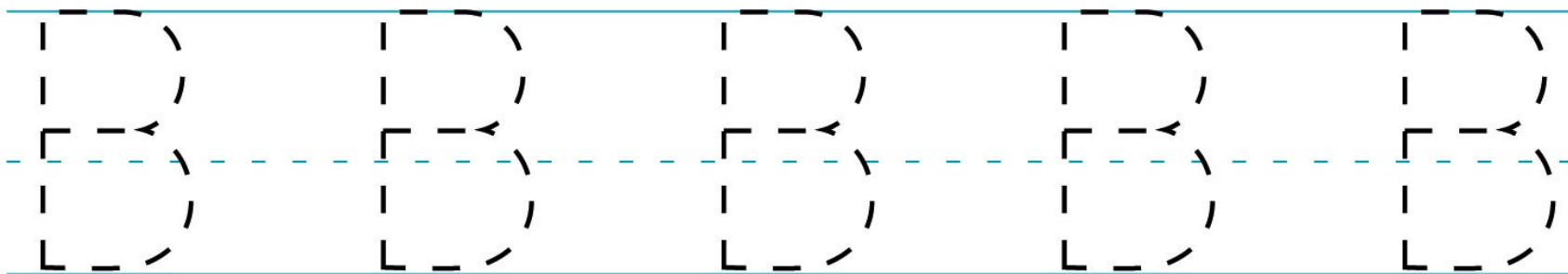
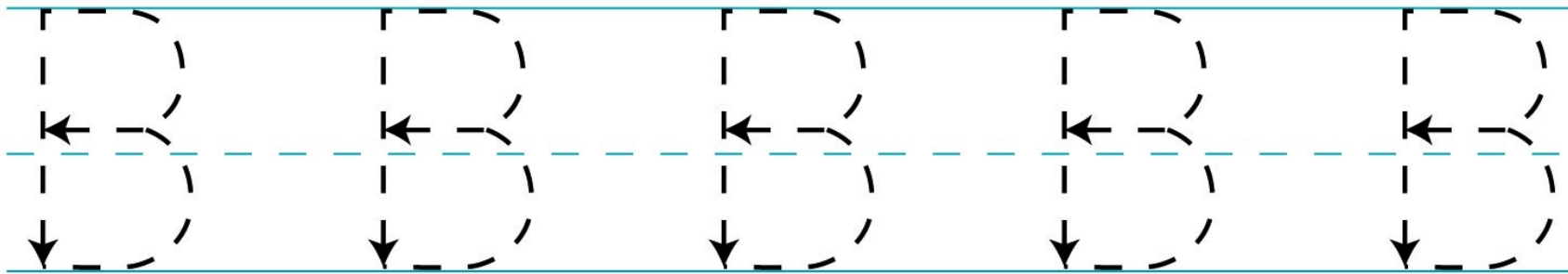
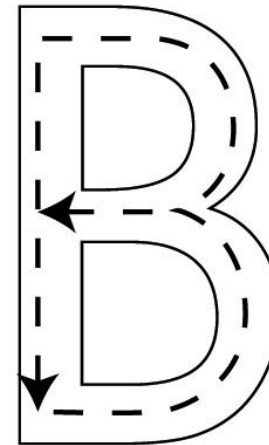
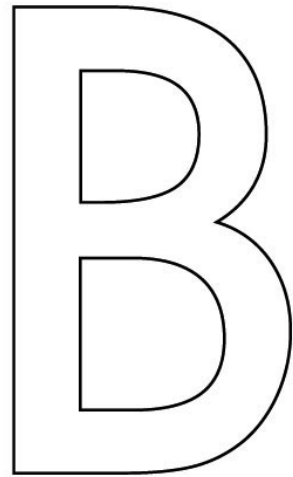

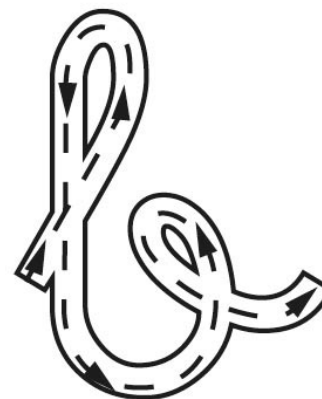
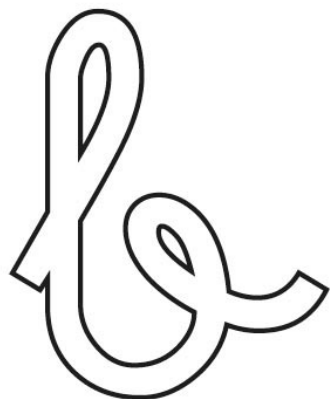

Tracing practice area with three rows of five dashed cursive 'e' characters on lined paper.

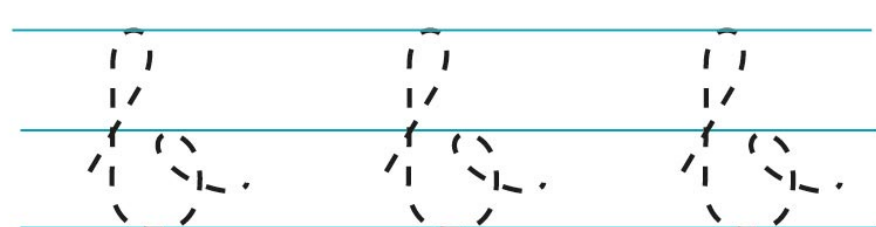
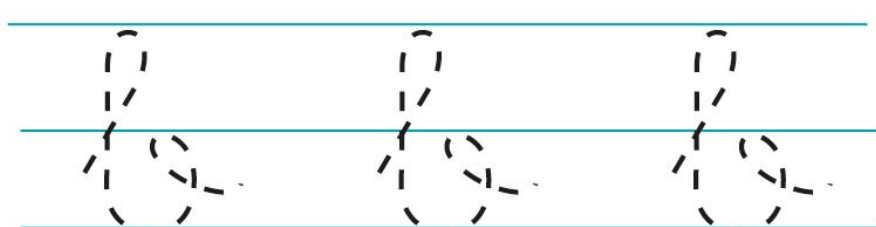
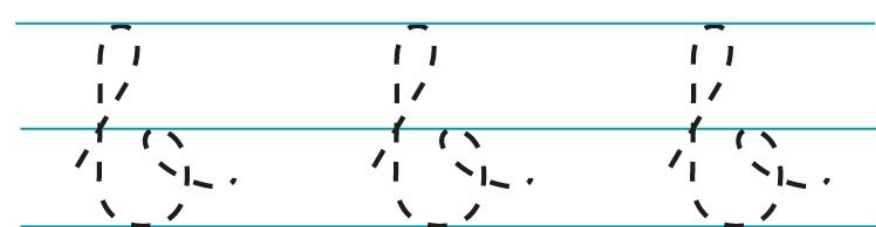
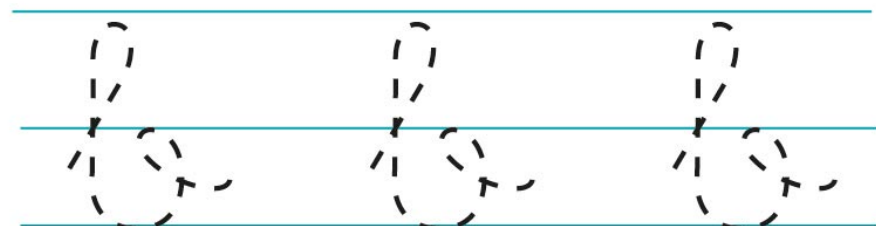
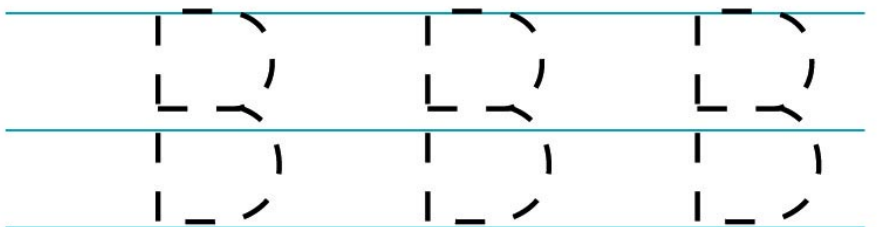
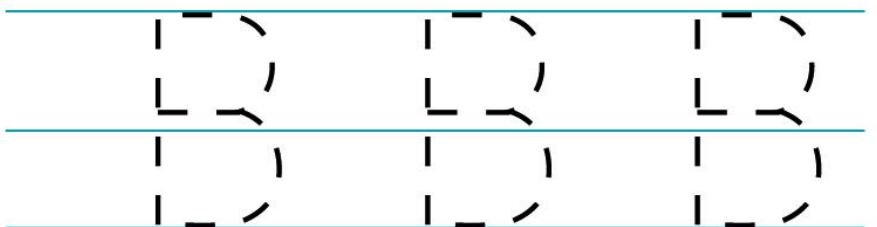
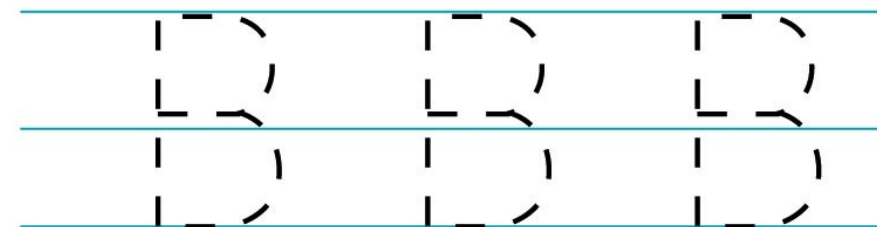
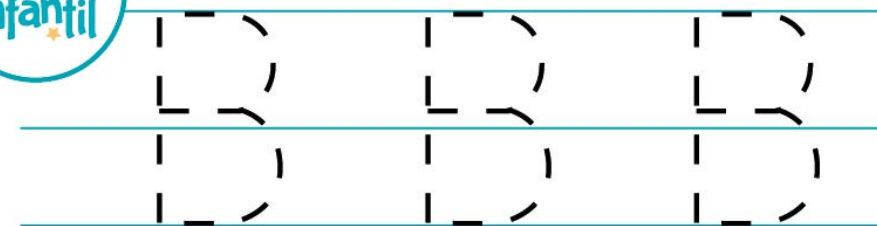

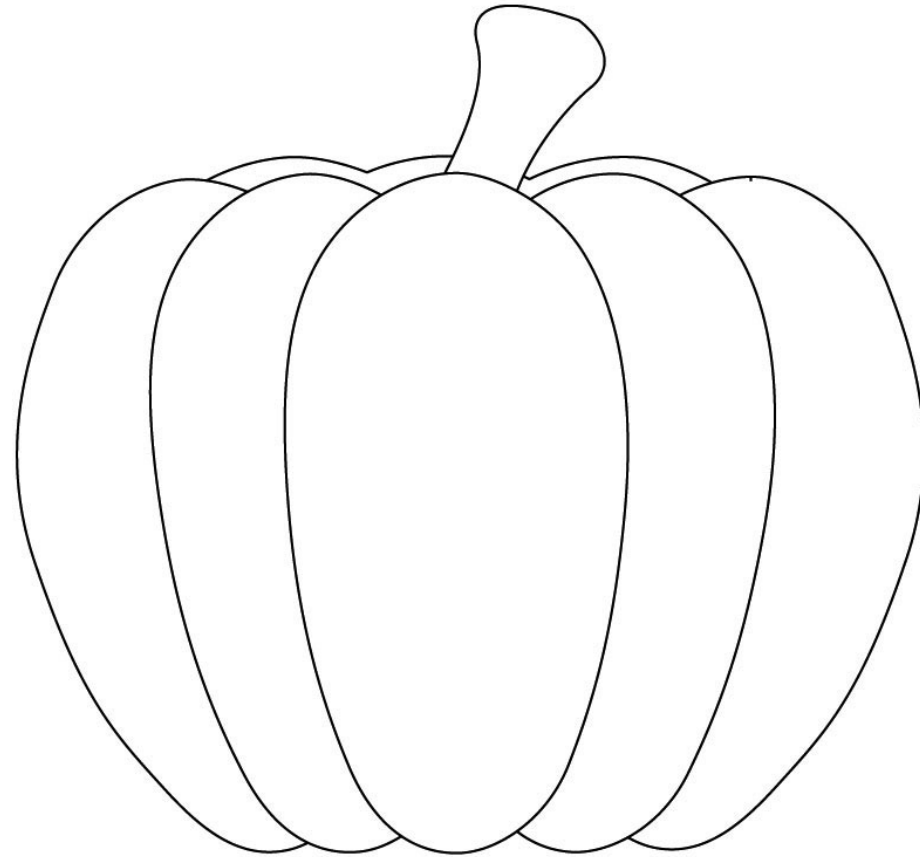
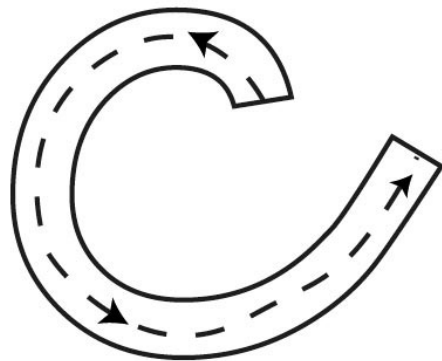
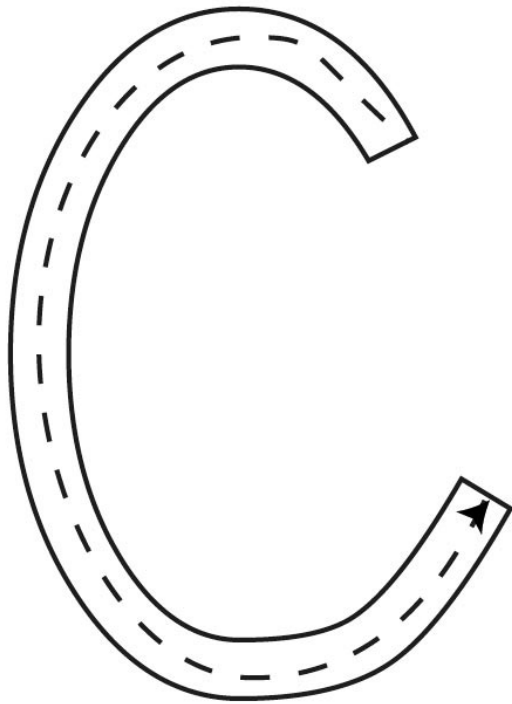

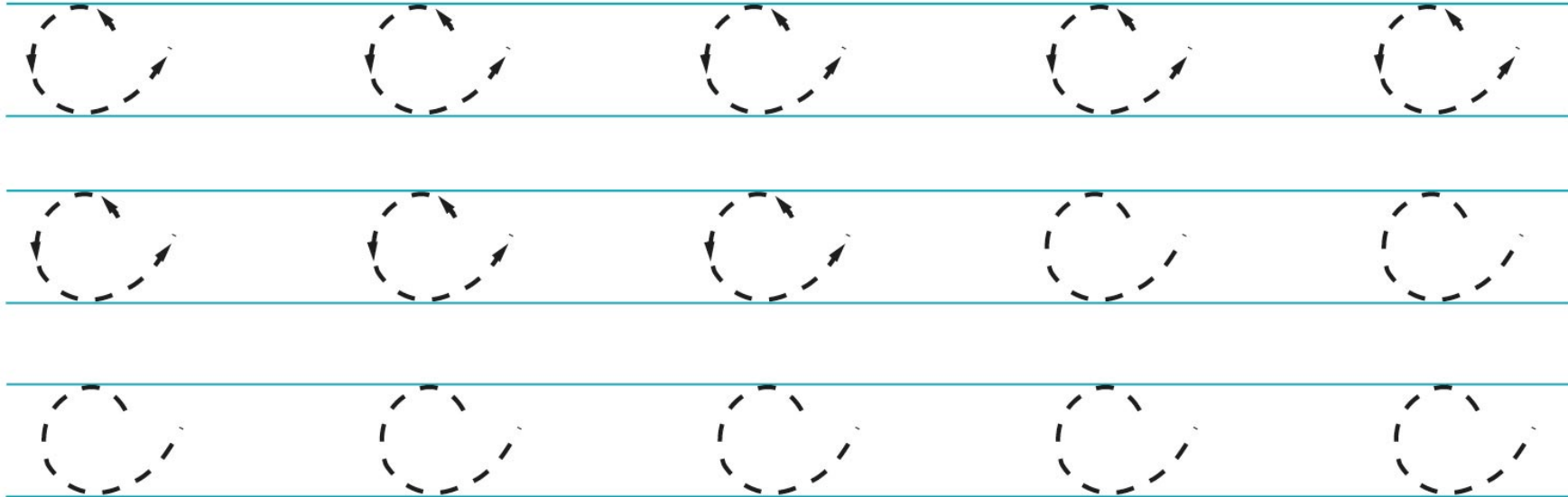
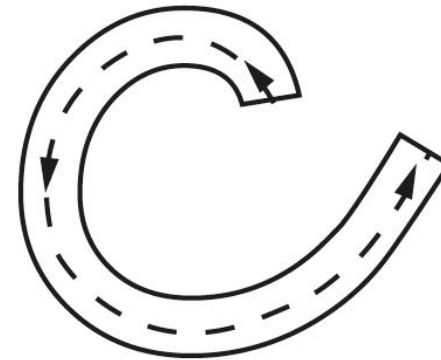
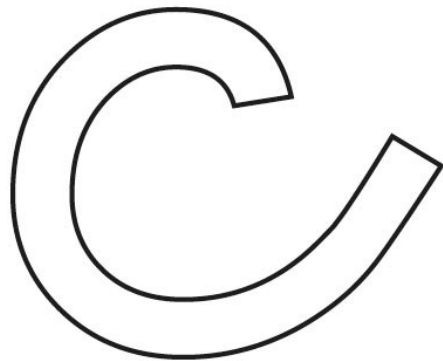

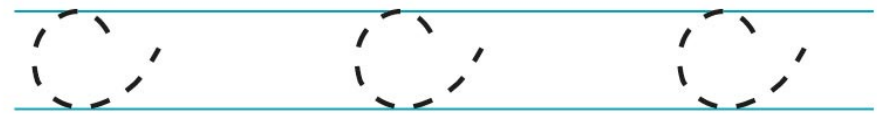
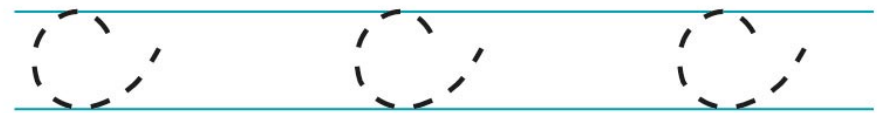
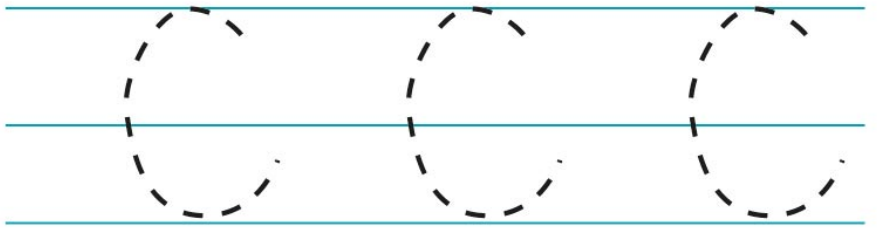
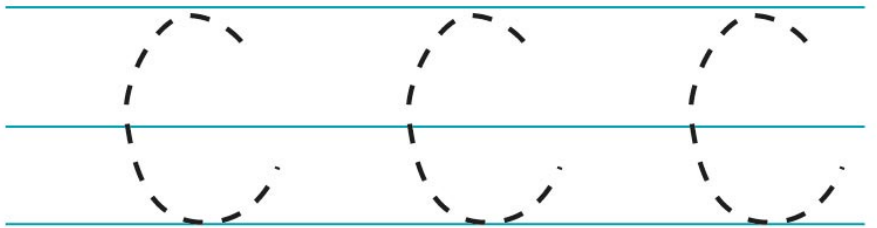
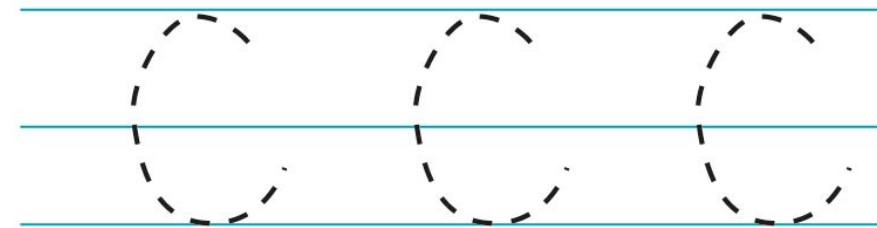
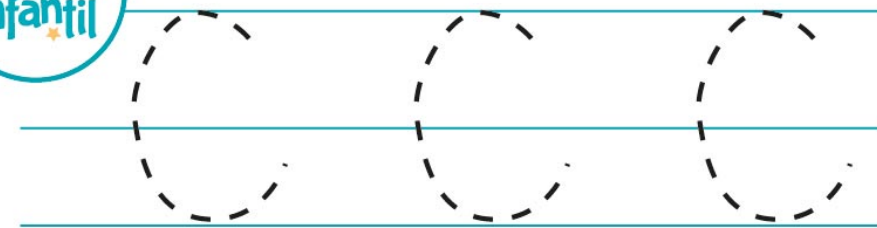

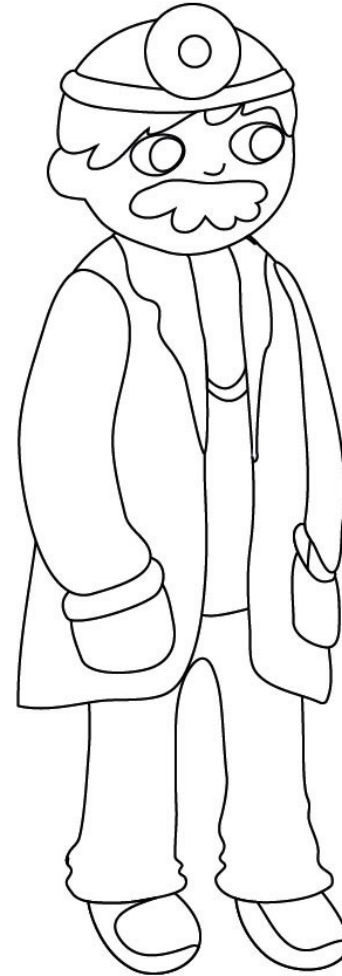
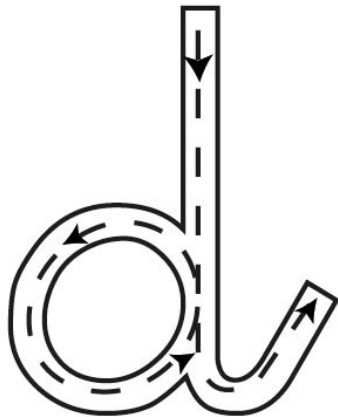
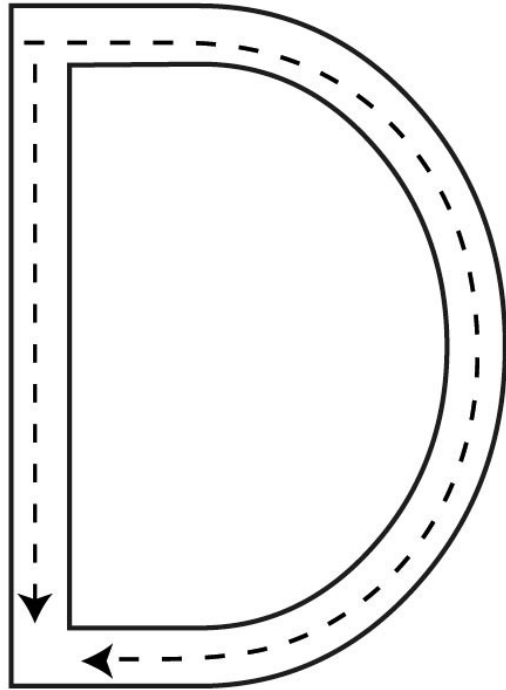

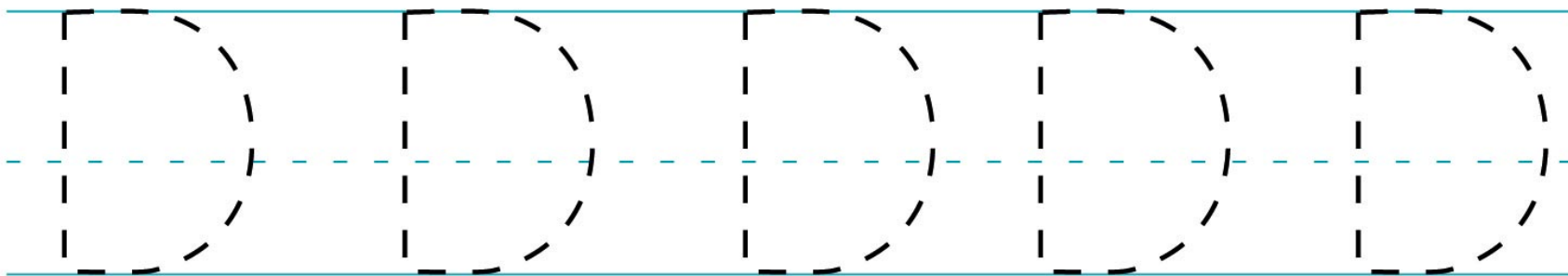
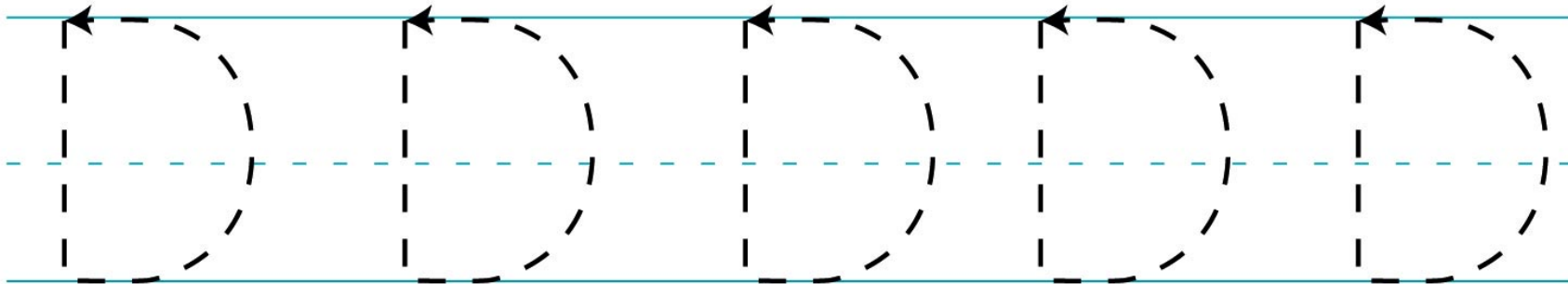
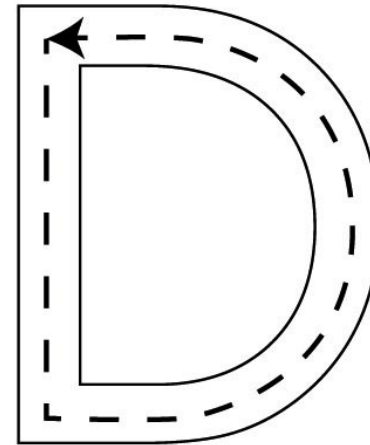
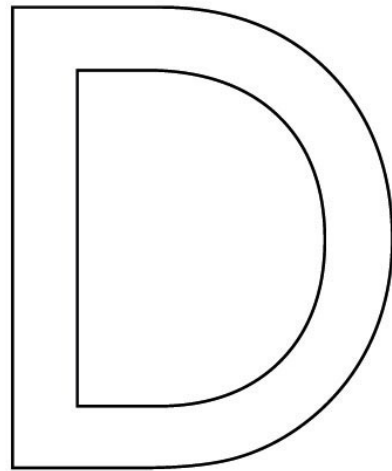

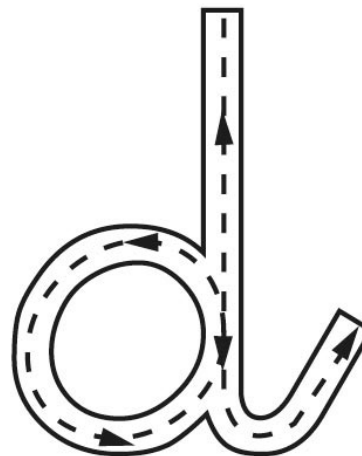

Tracing practice section with three rows of five dashed lowercase 'd' characters on a four-line grid. Each character has a vertical dashed line above it with an upward-pointing arrow, indicating the starting point and direction for the first stroke.

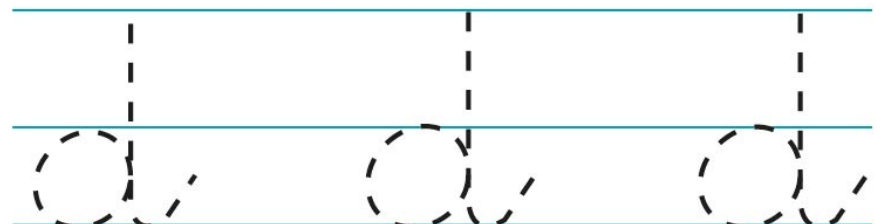
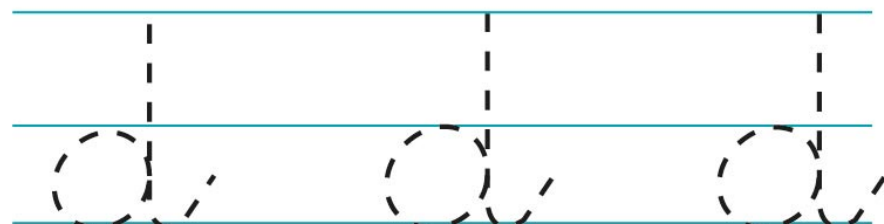
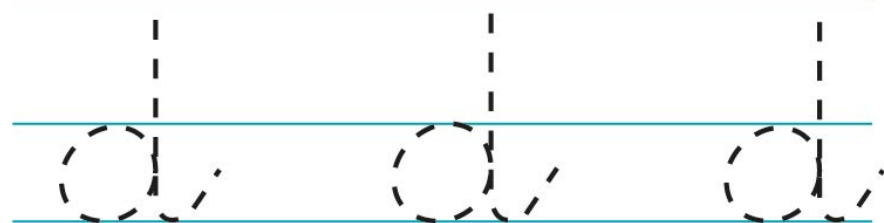
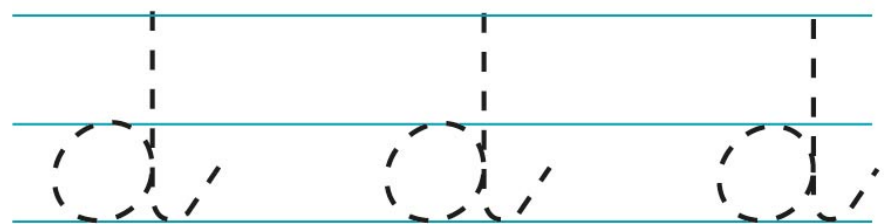
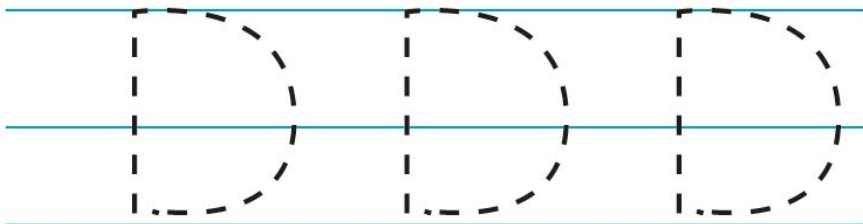
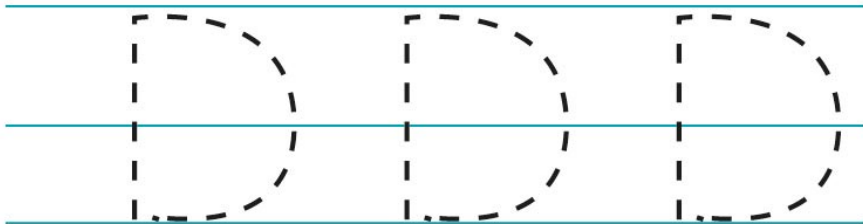
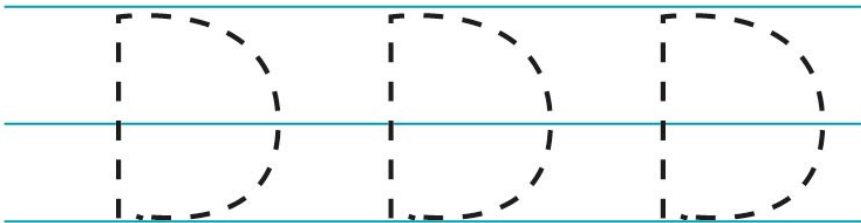
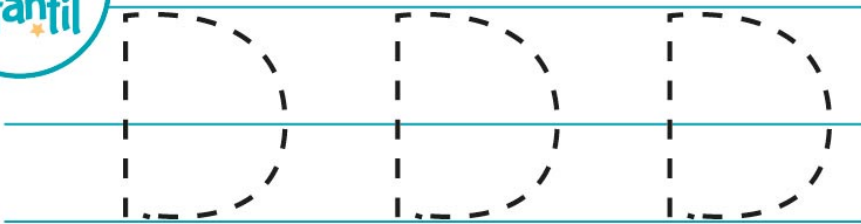

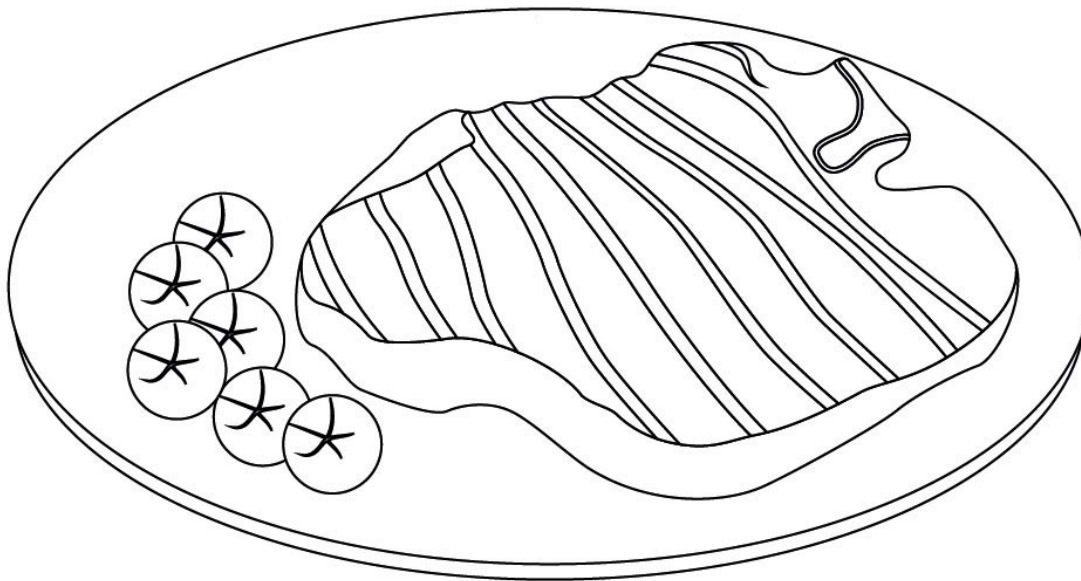
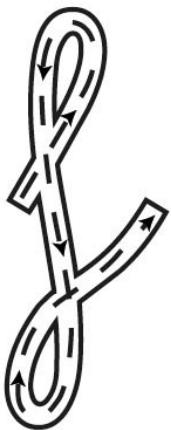
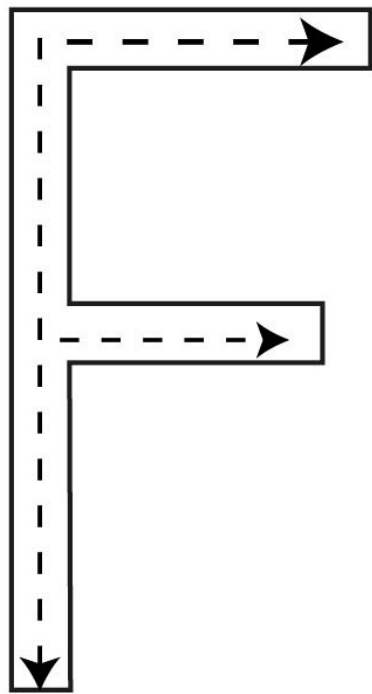

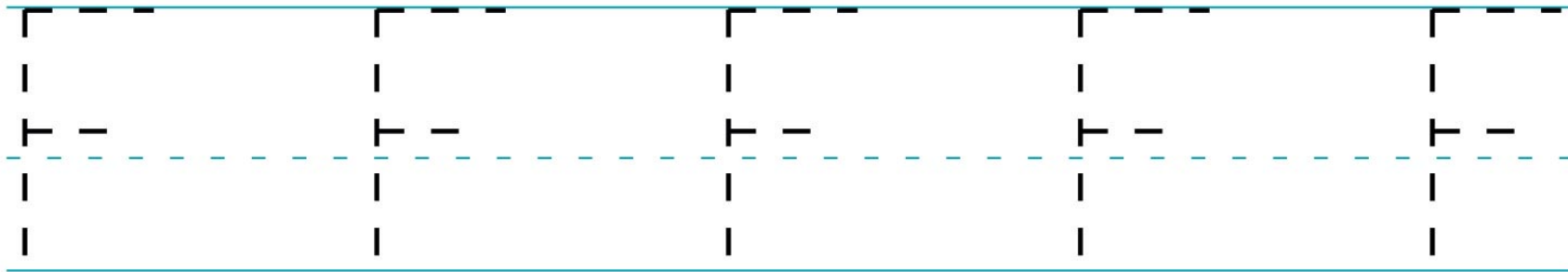
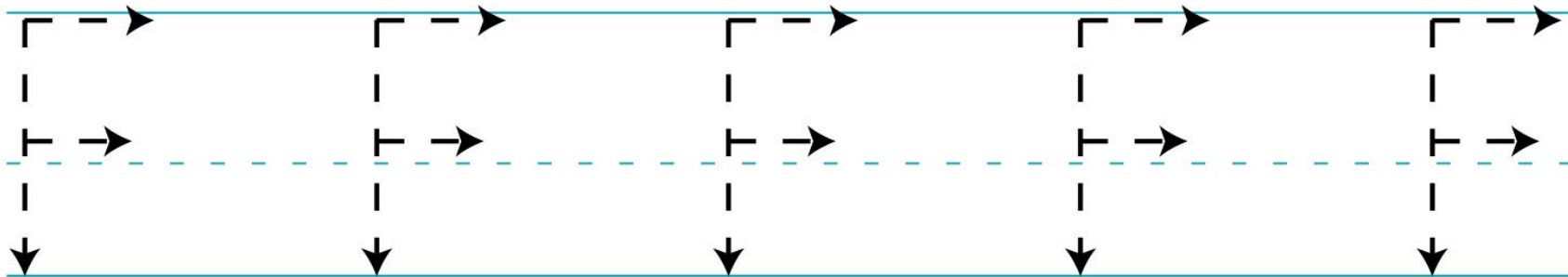
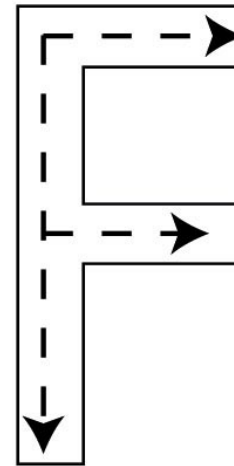
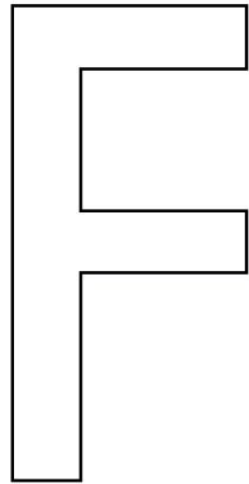

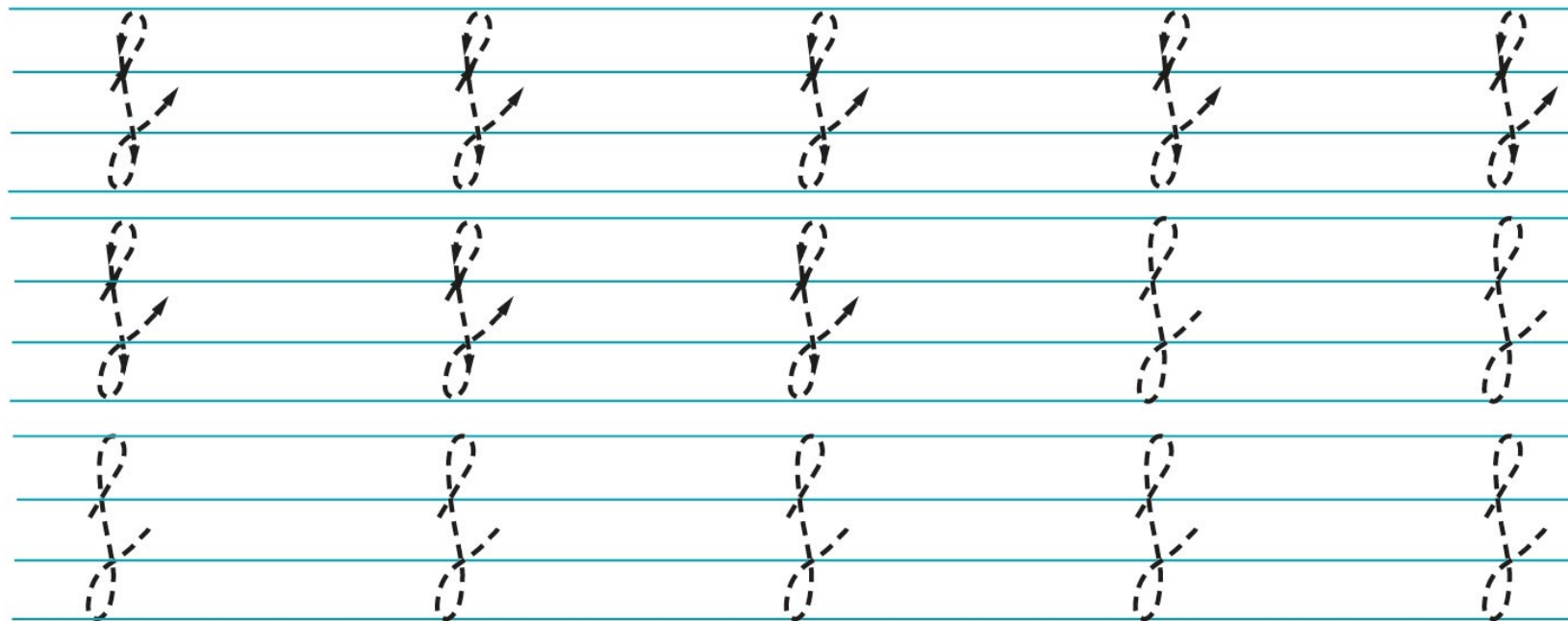
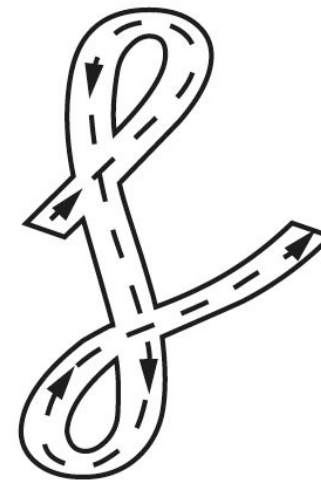
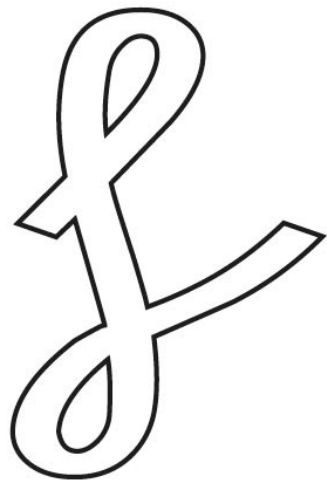

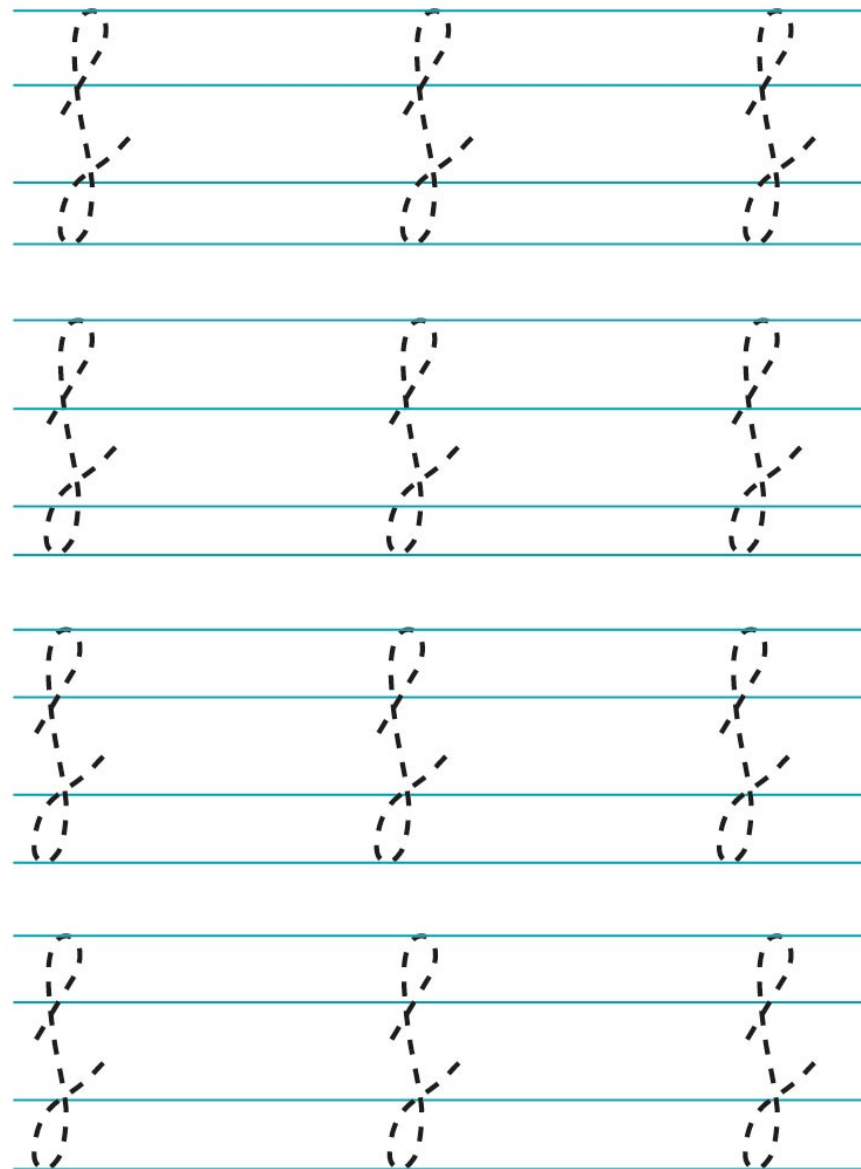
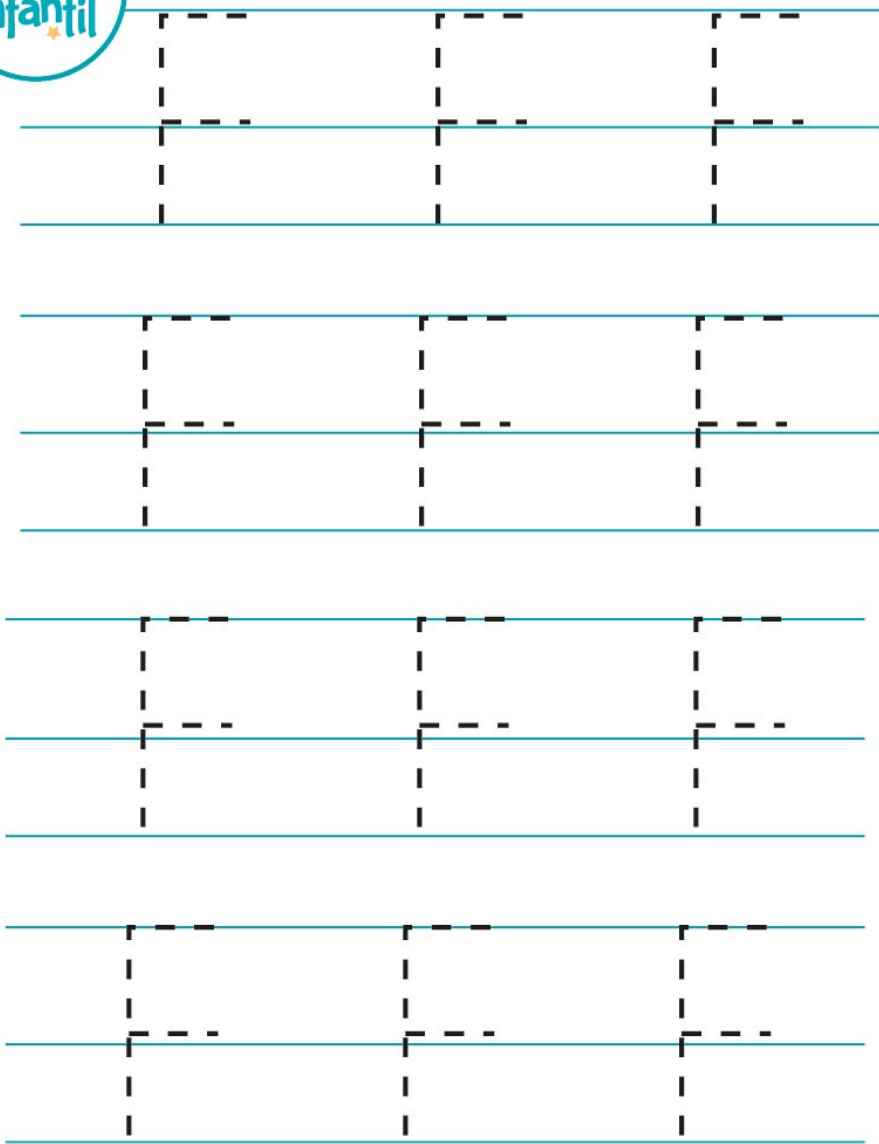

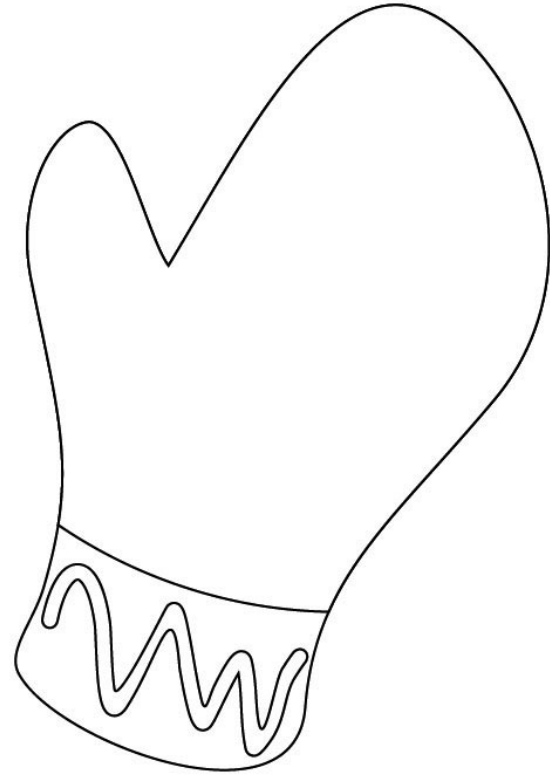
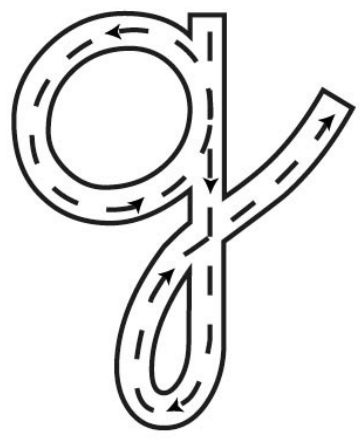
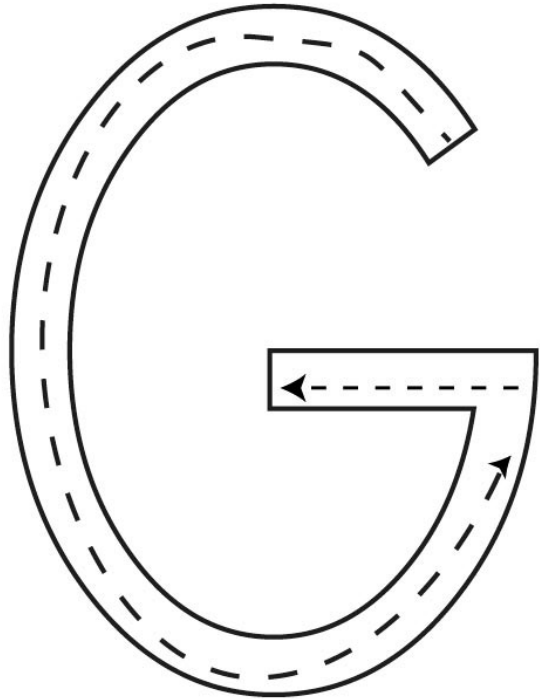

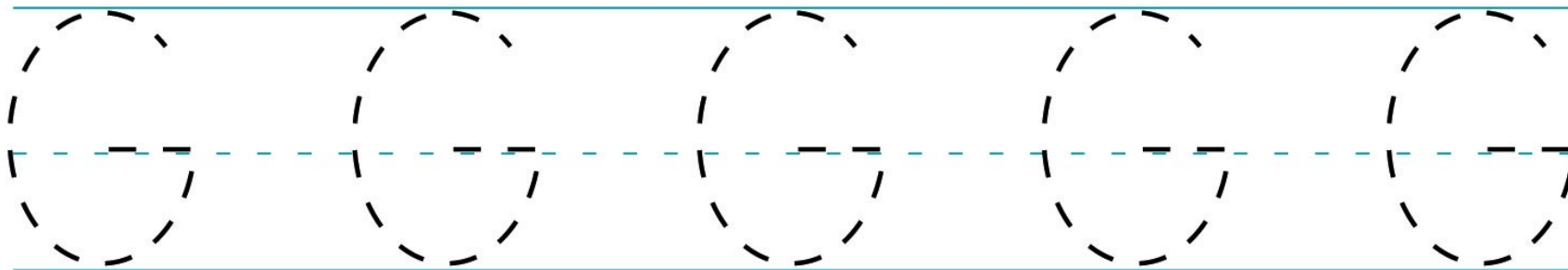
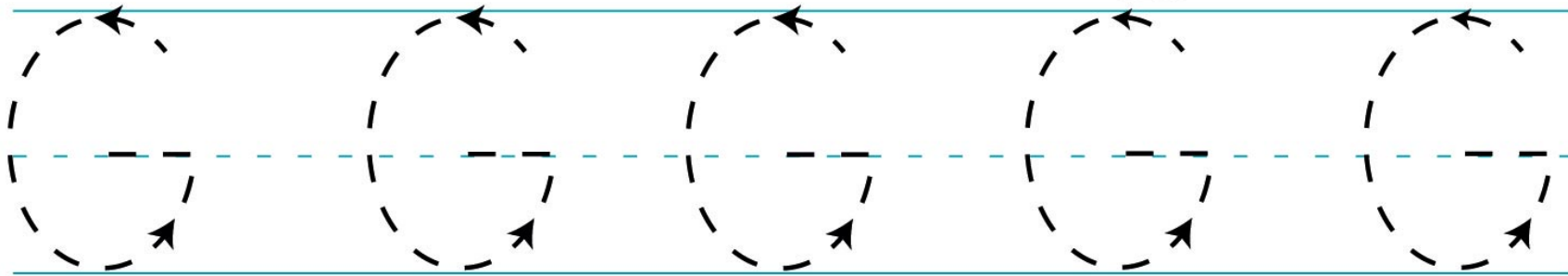
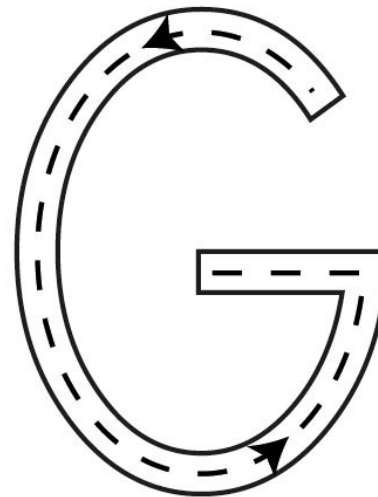

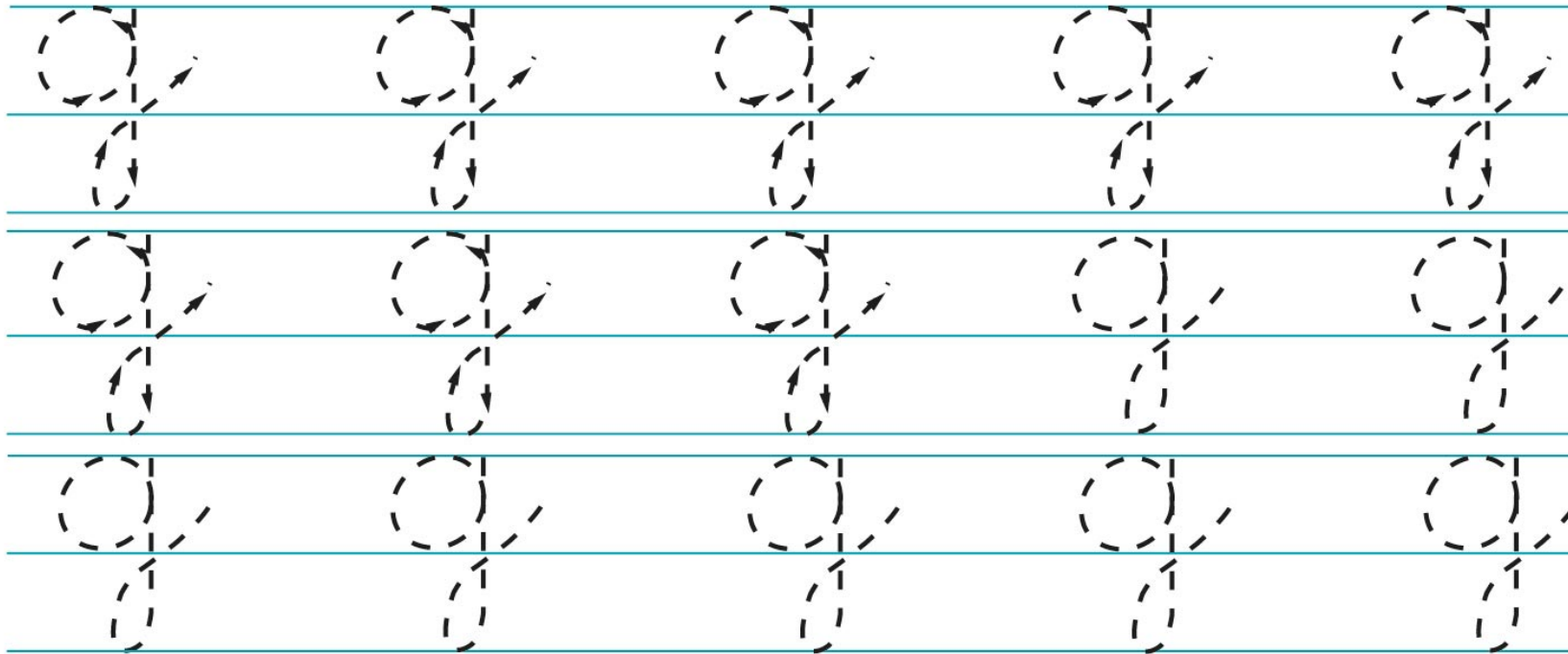
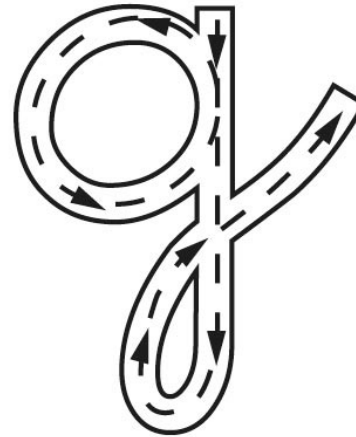

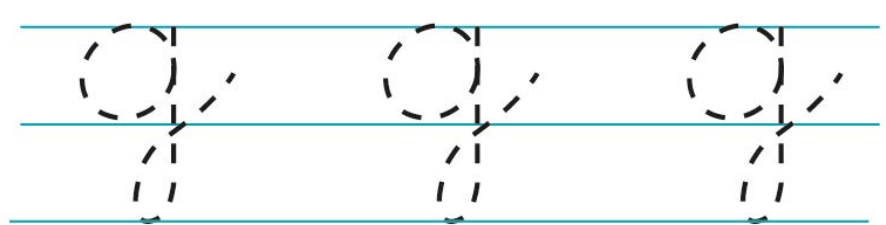
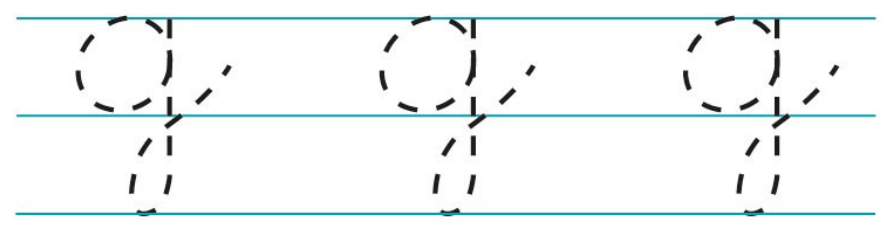
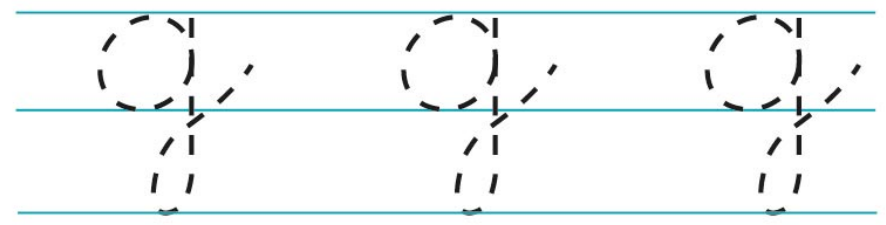
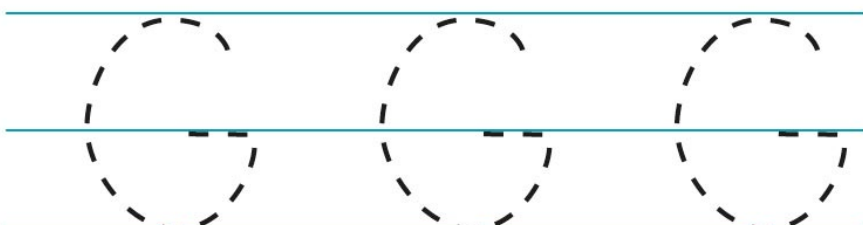
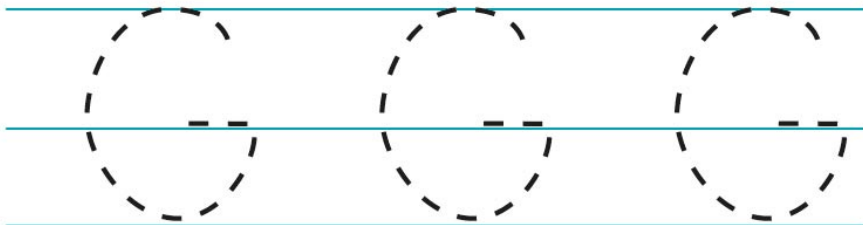
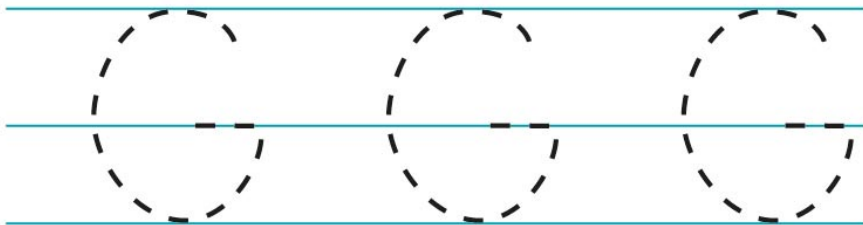
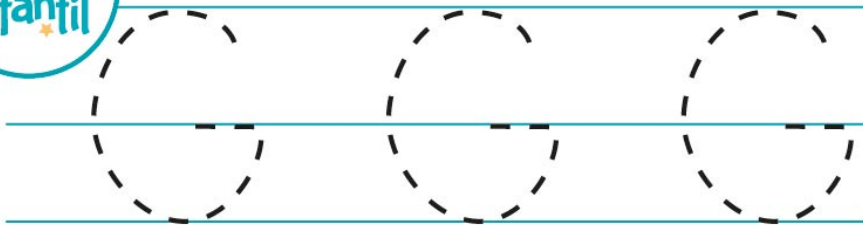

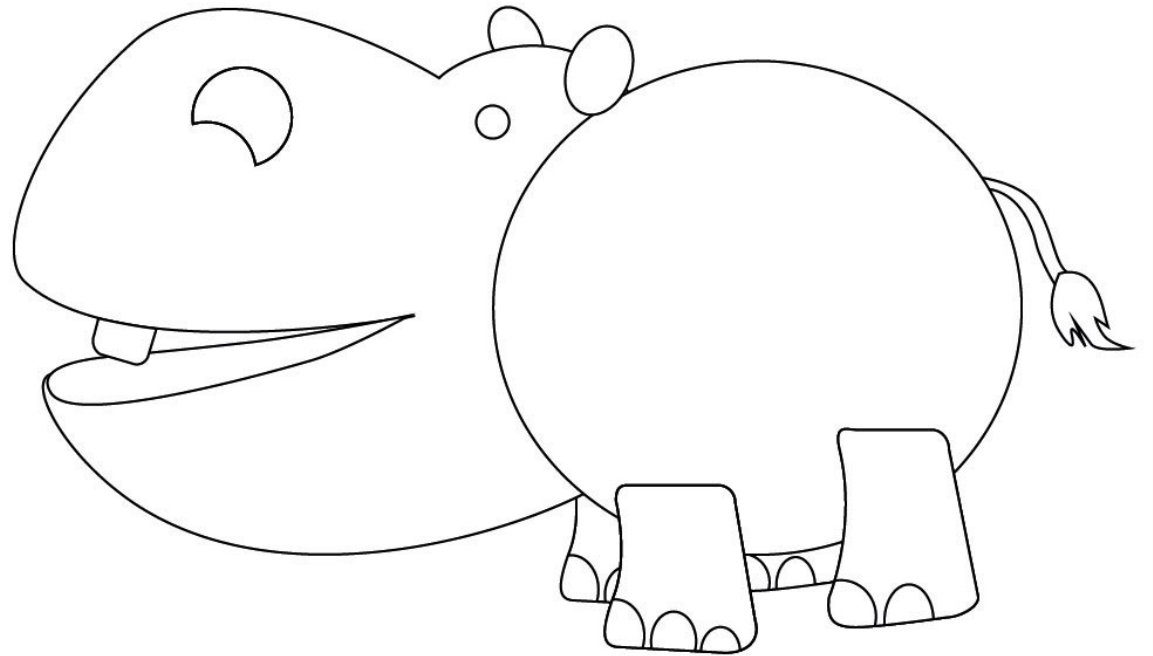
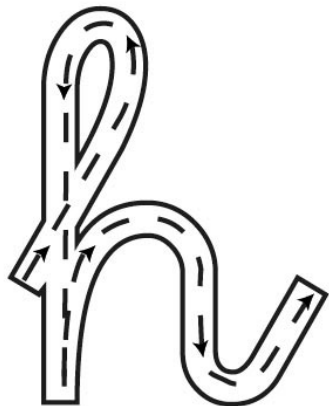
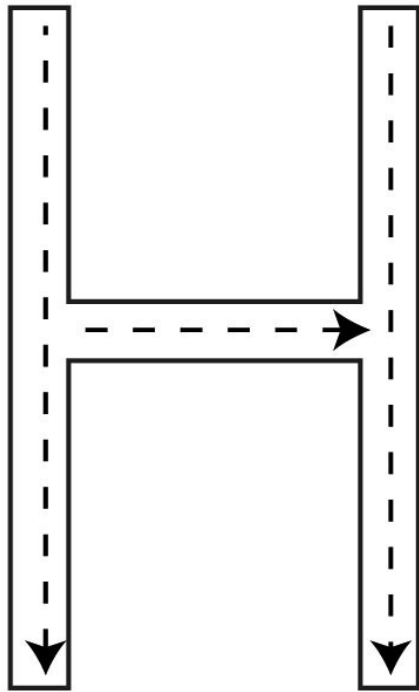

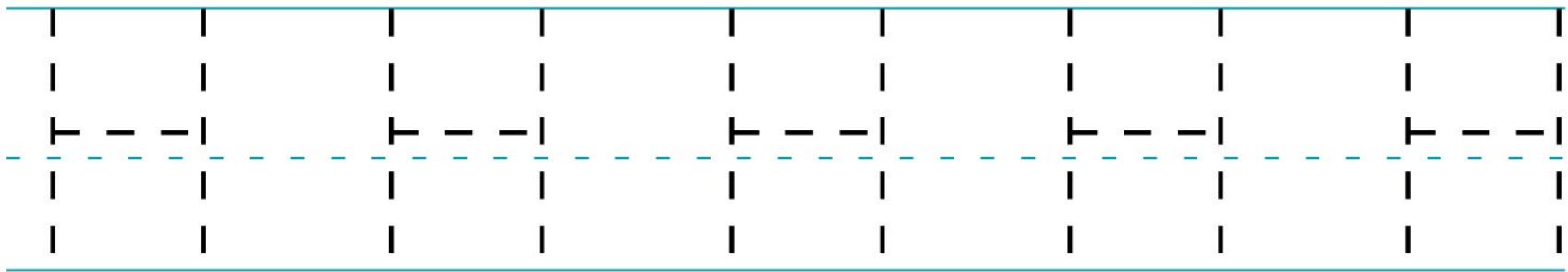
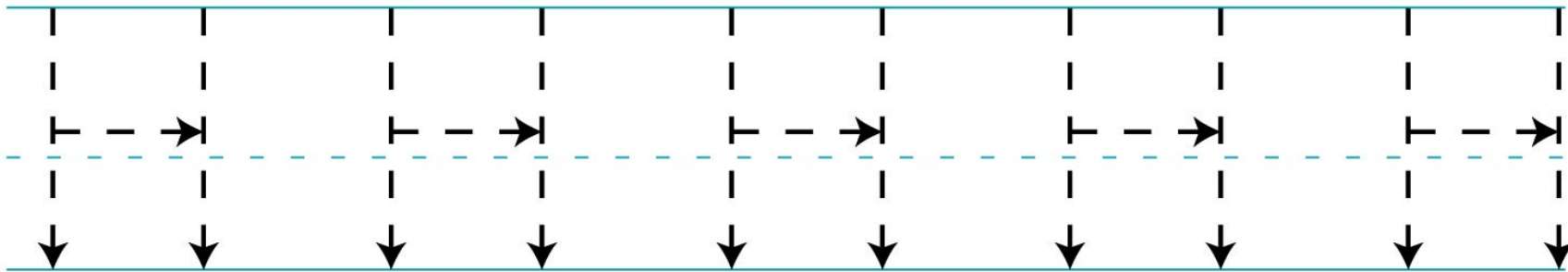
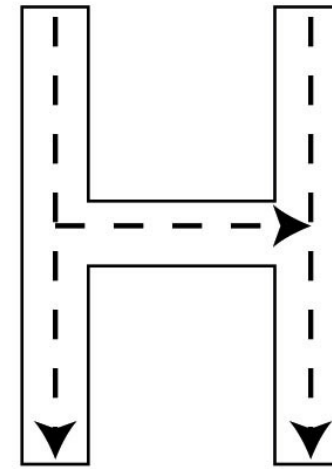
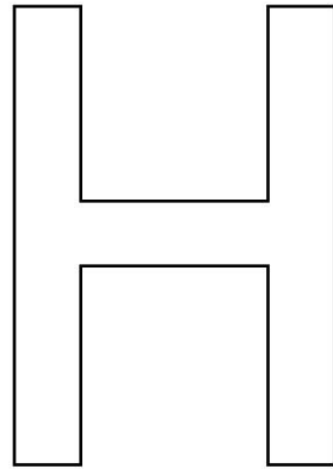

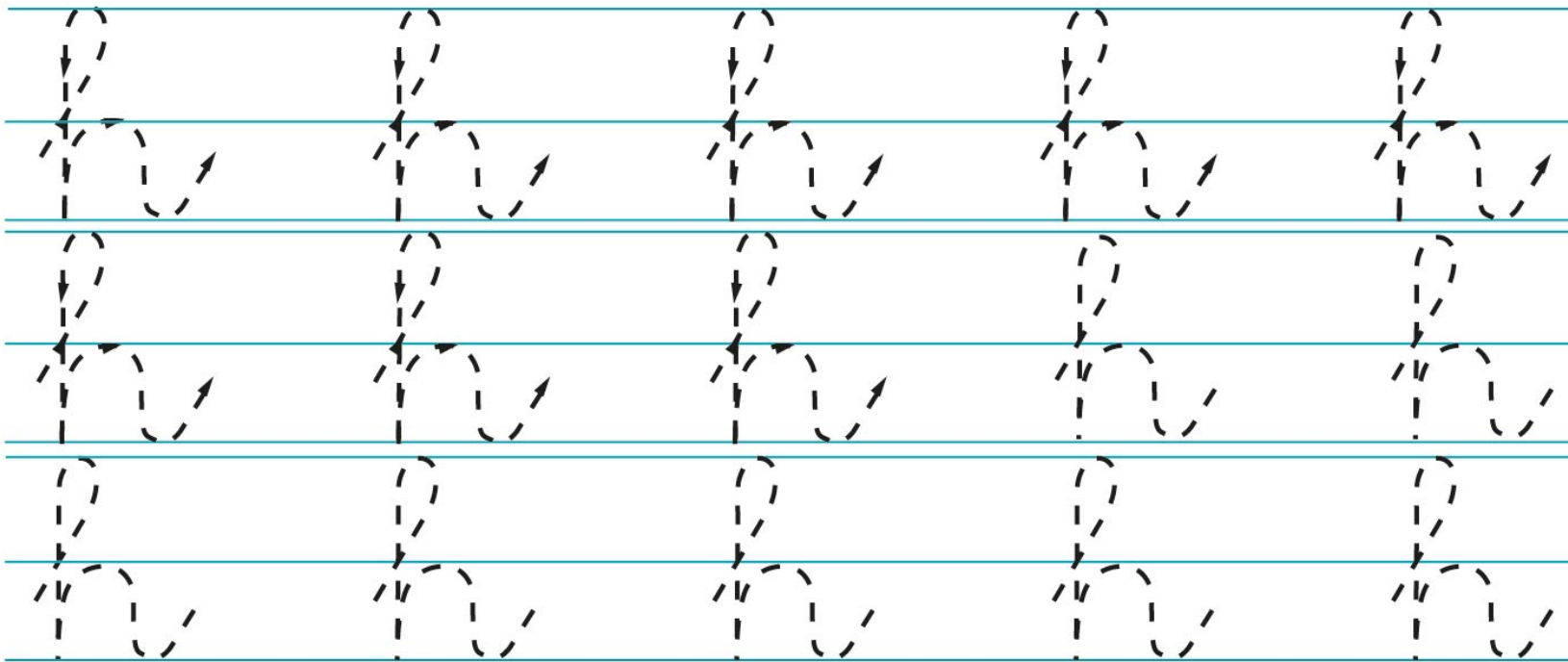
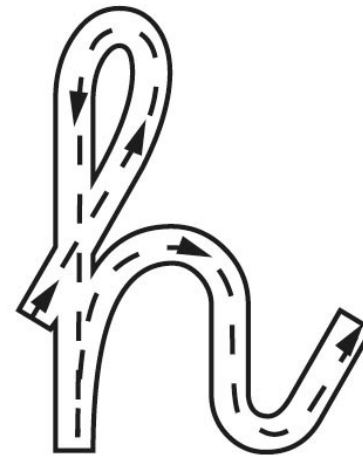
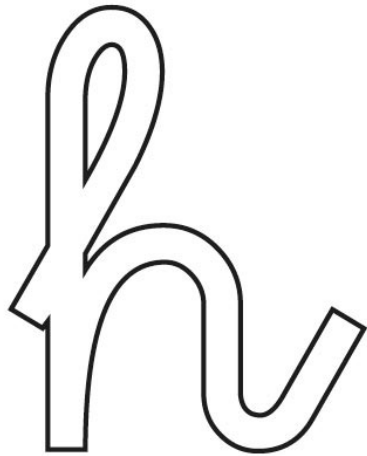

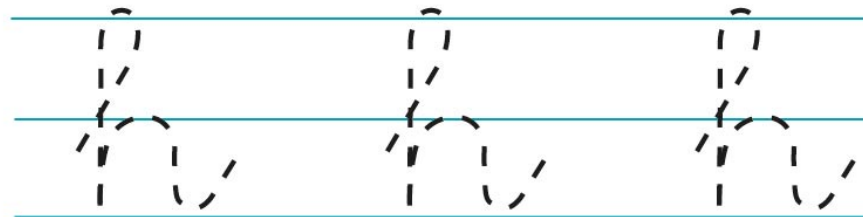
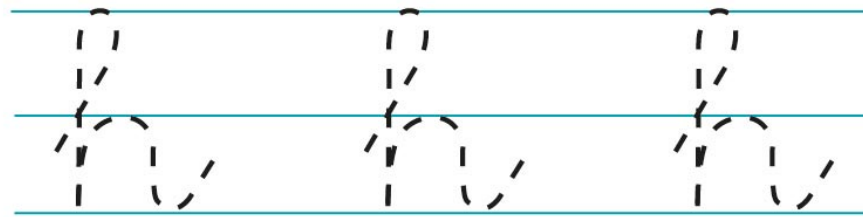
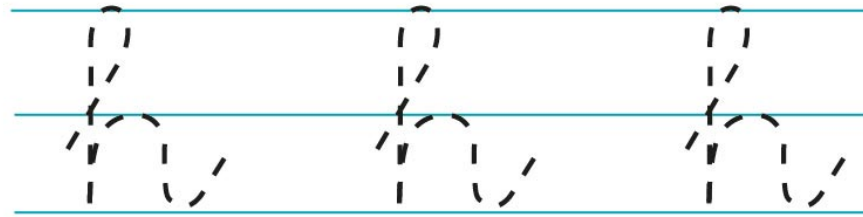
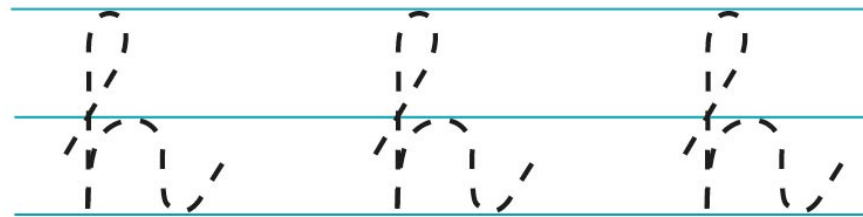
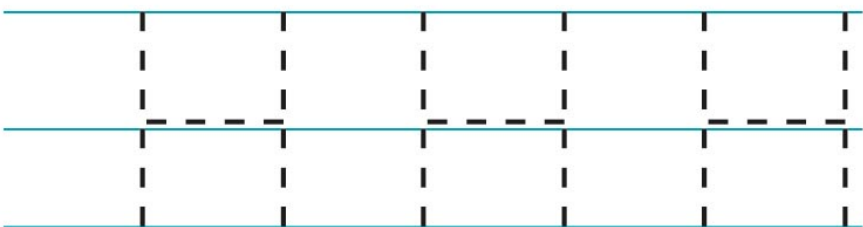
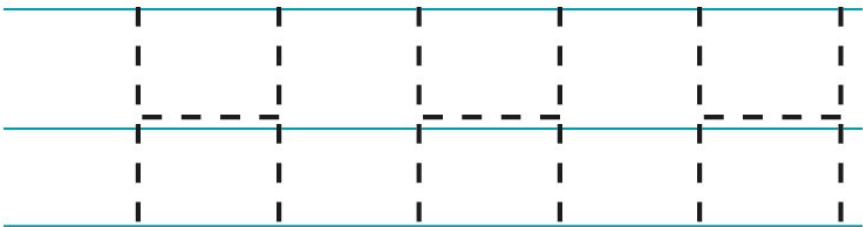
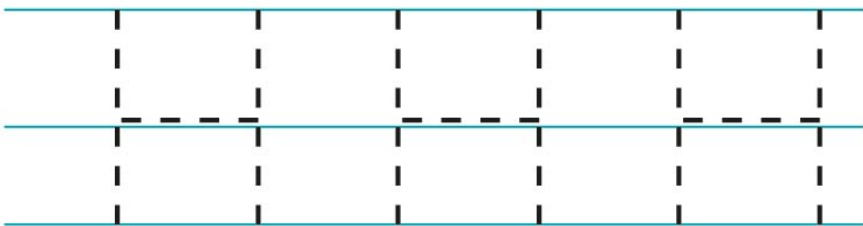
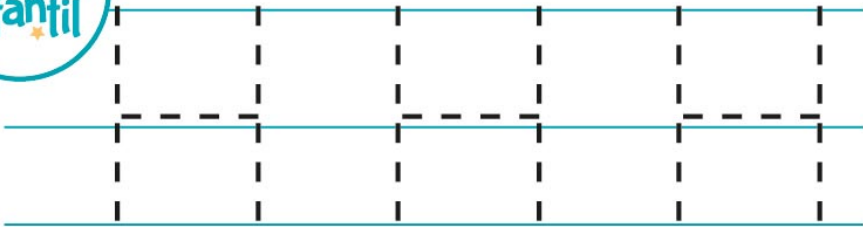

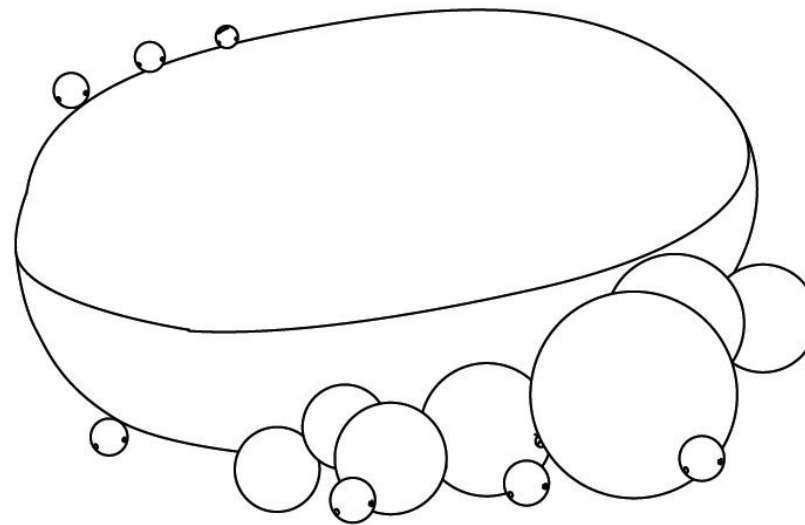
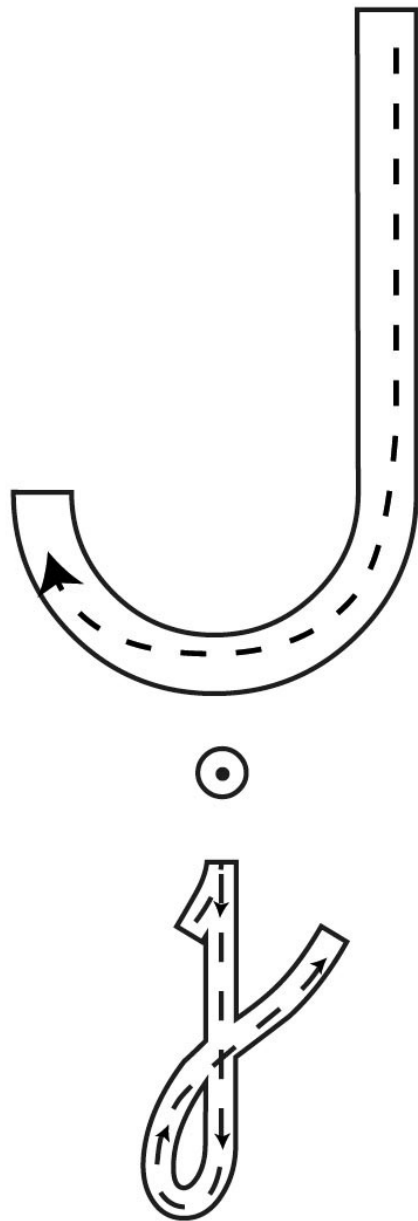

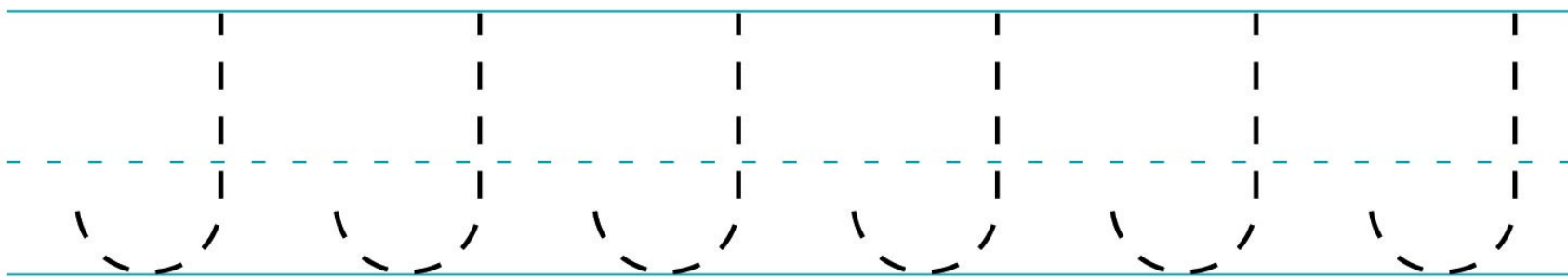
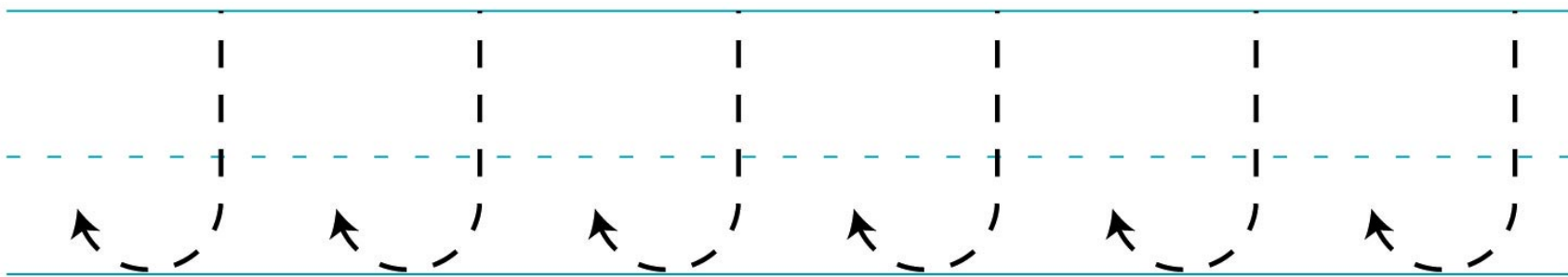
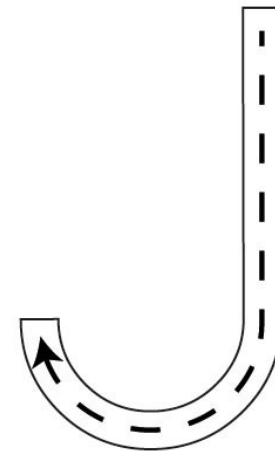
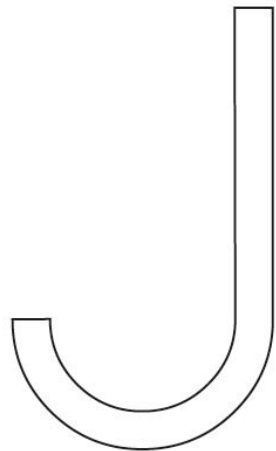

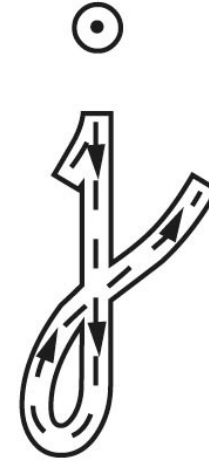
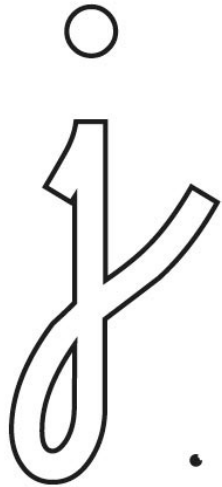

Tracing practice for the letter 'y' on a four-line grid. The first row contains five dashed 'y' characters, each with a starting dot and a downward arrow. The second row contains five dashed 'y' characters, each with a starting dot and a downward arrow. The third row contains five dashed 'y' characters, each with a starting dot and a downward arrow.

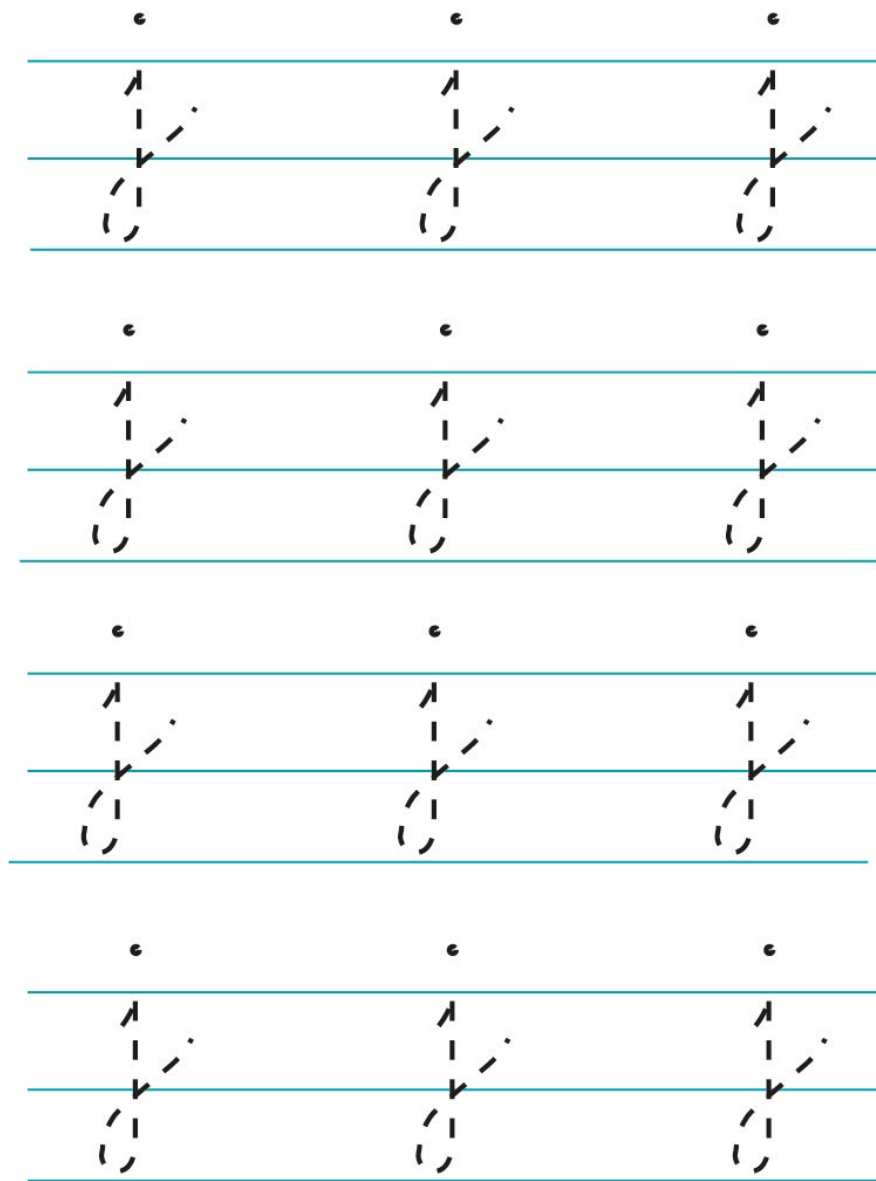
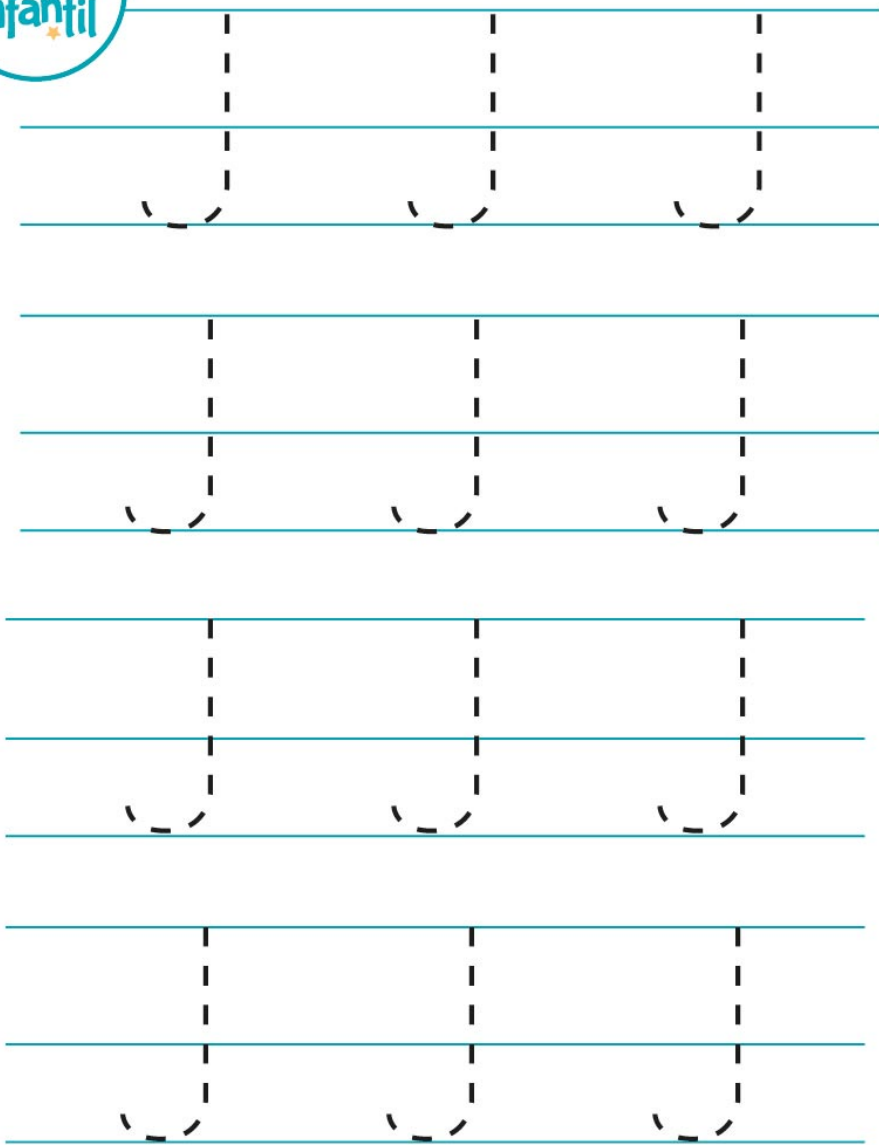

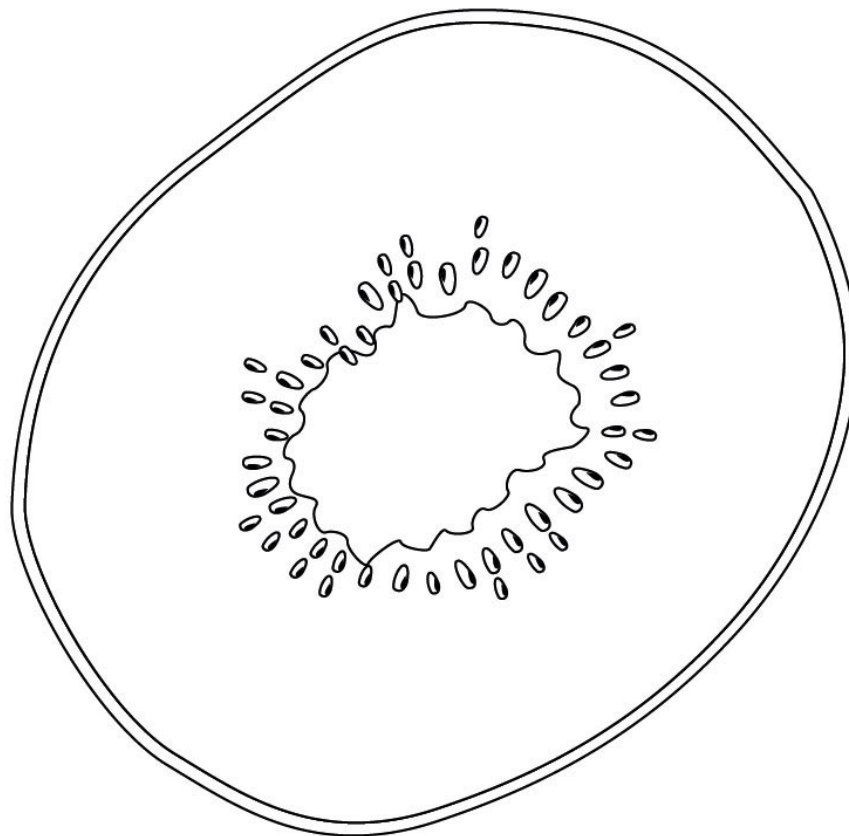
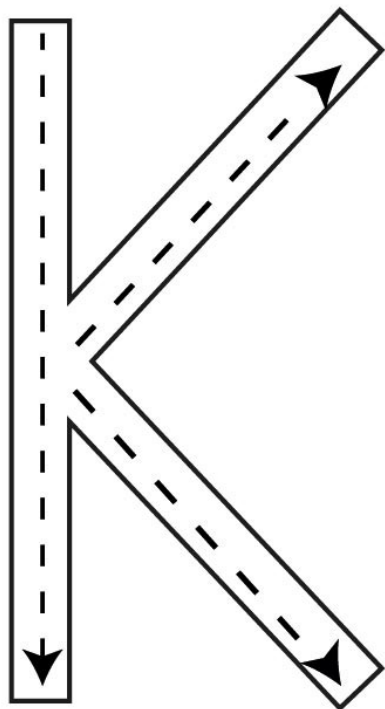

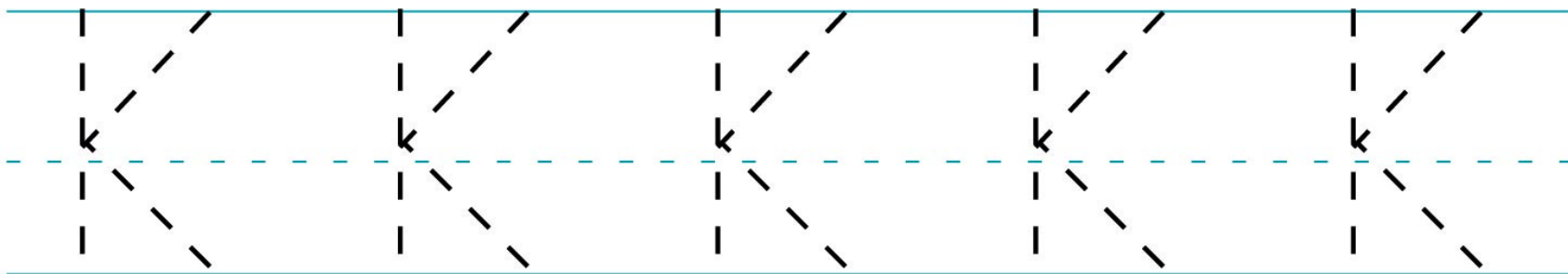
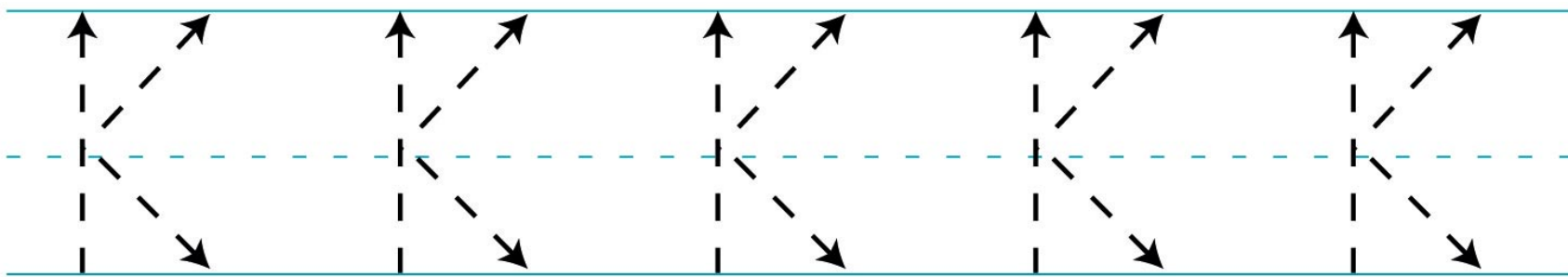
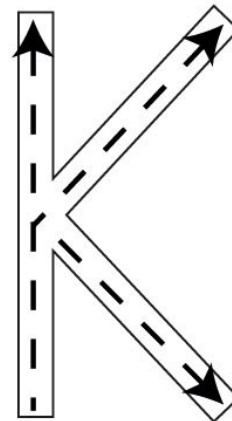
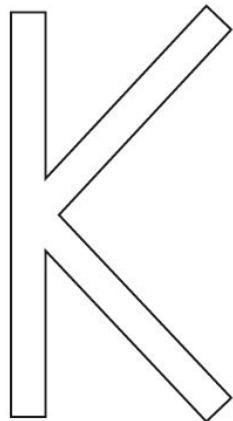

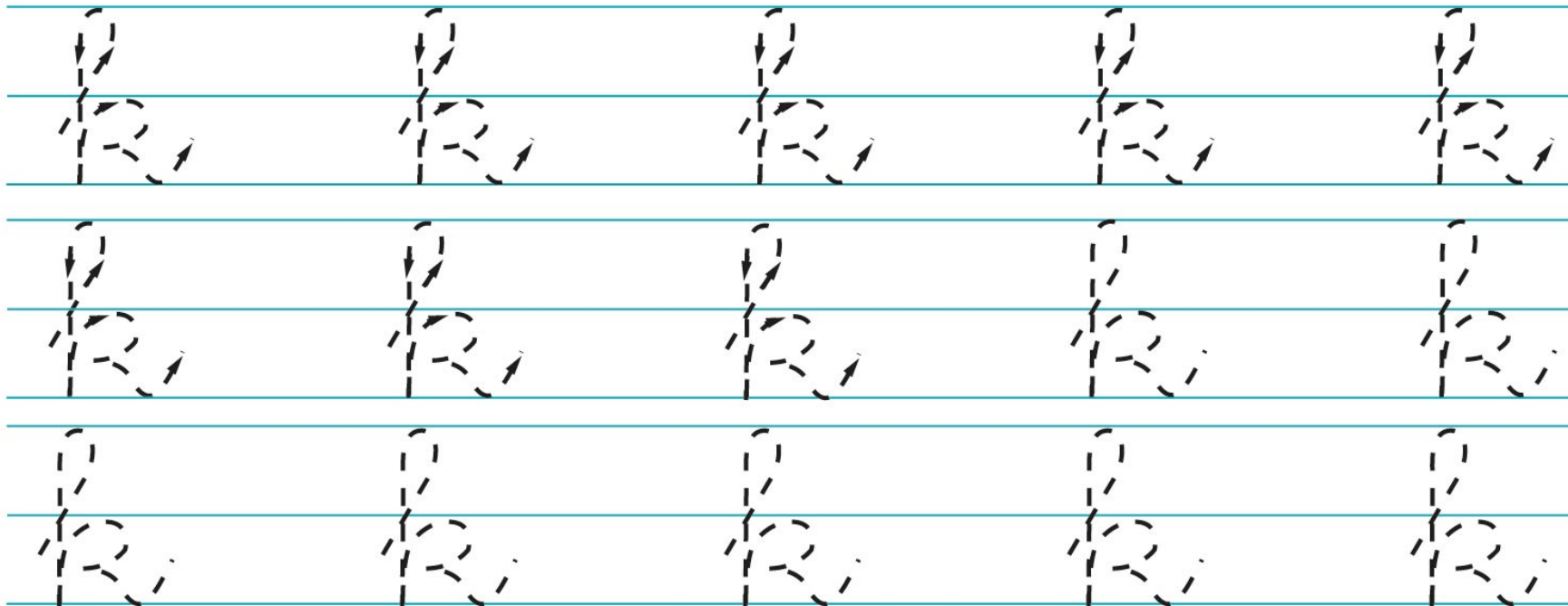

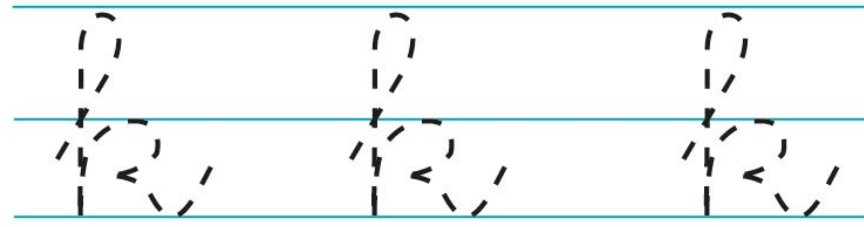
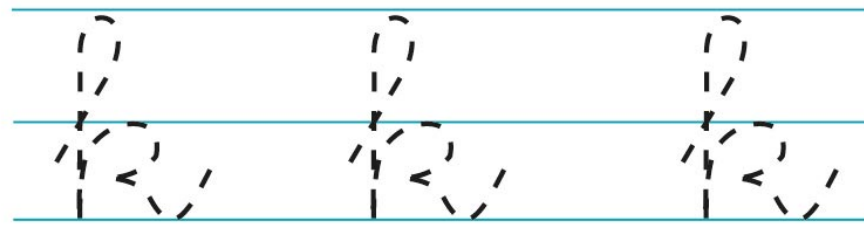
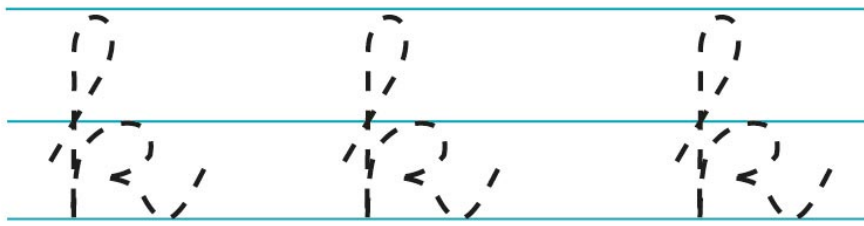
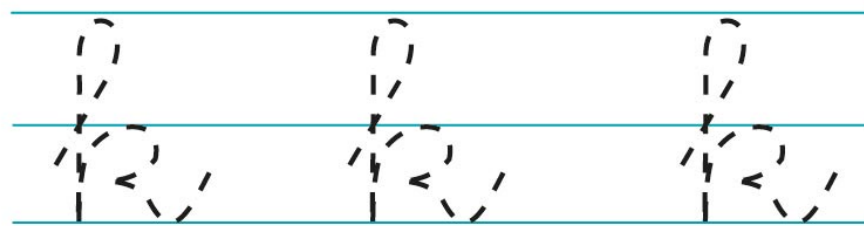
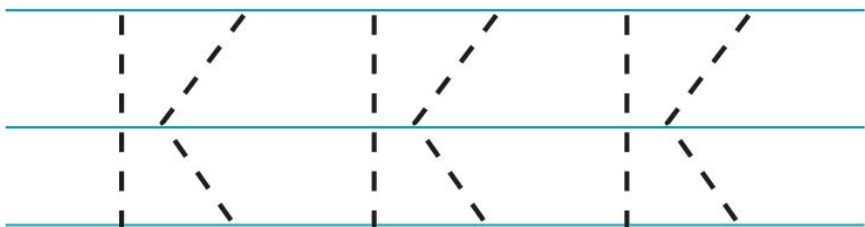
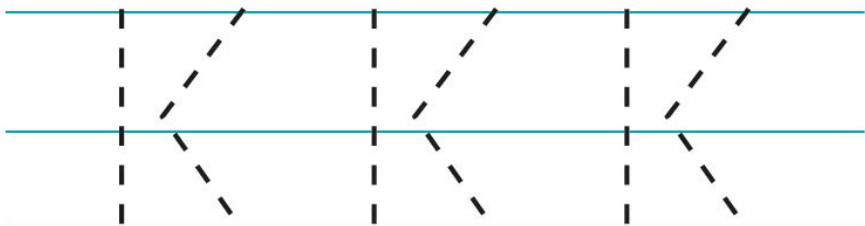
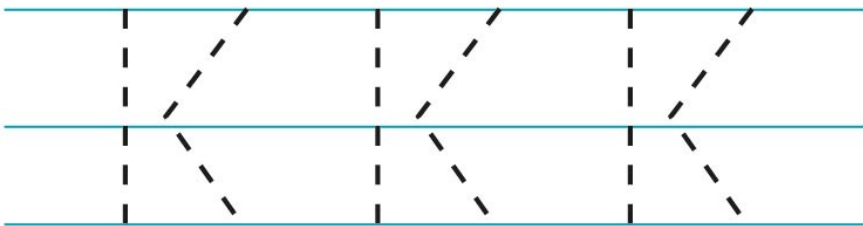
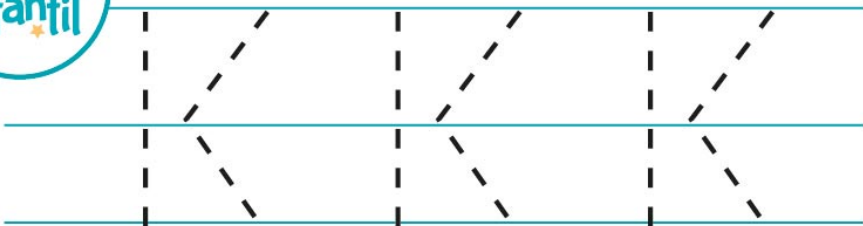

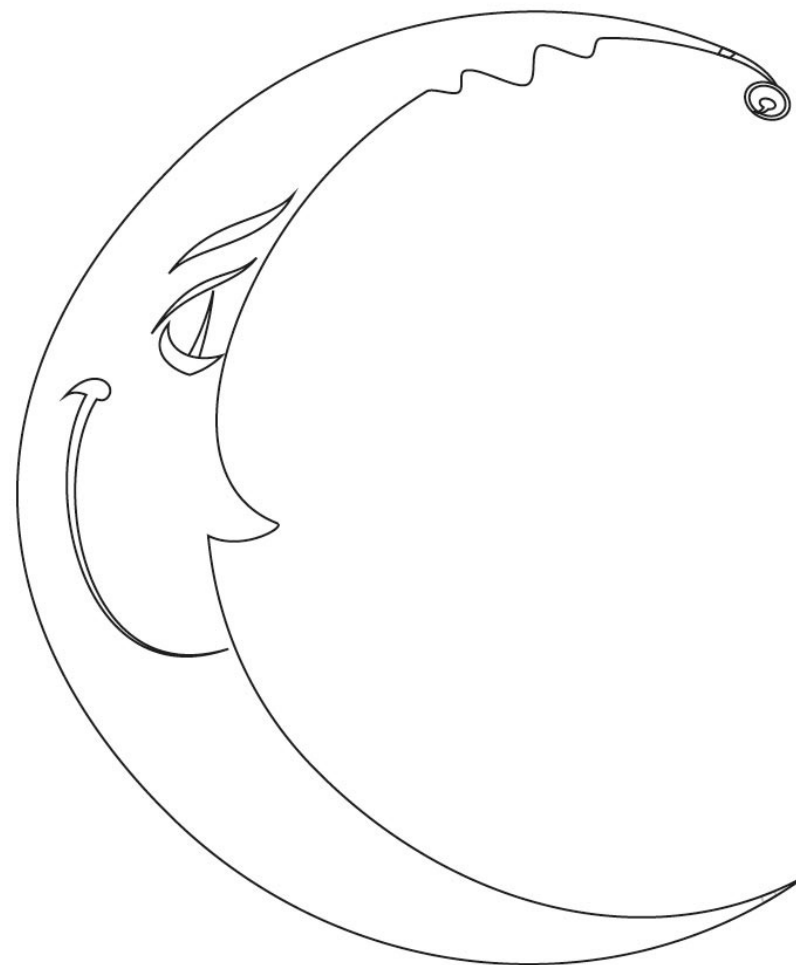
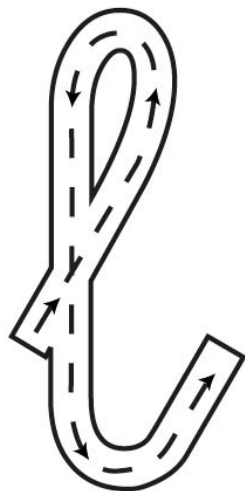
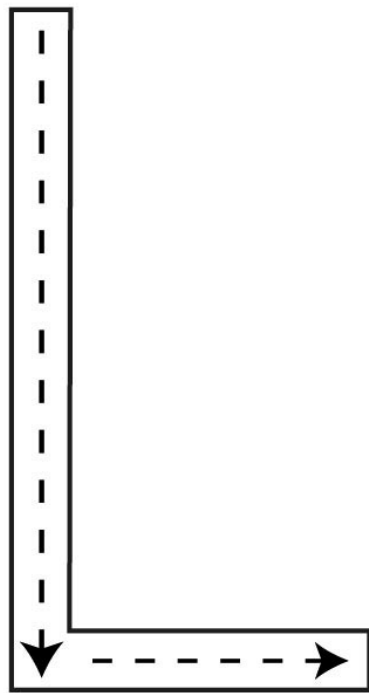

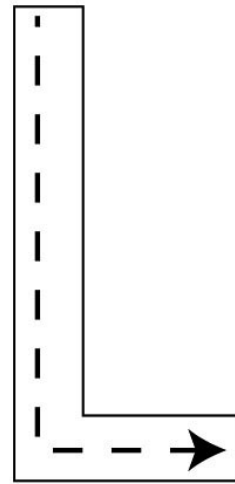
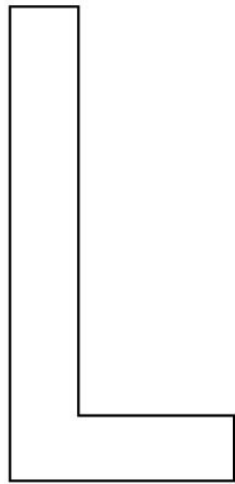

Tracing practice area with two rows of five dashed 'L' characters on a three-line grid. The first row includes arrows and a starting dot for each letter. The second row shows the letters without arrows or dots.

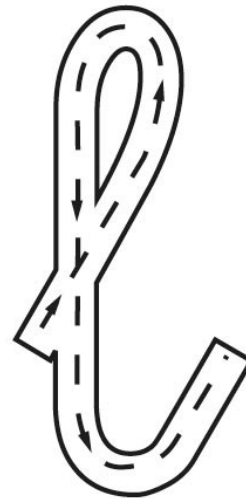
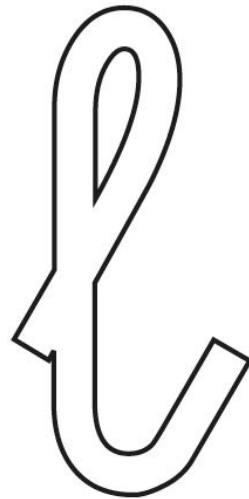

Tracing practice area consisting of three rows of horizontal lines. Each row contains five dashed outlines of the letter 'E' for tracing. The first row includes directional arrows on each 'E' to show the stroke order: a vertical line down, a top horizontal line from left to right, and a bottom horizontal line from left to right.

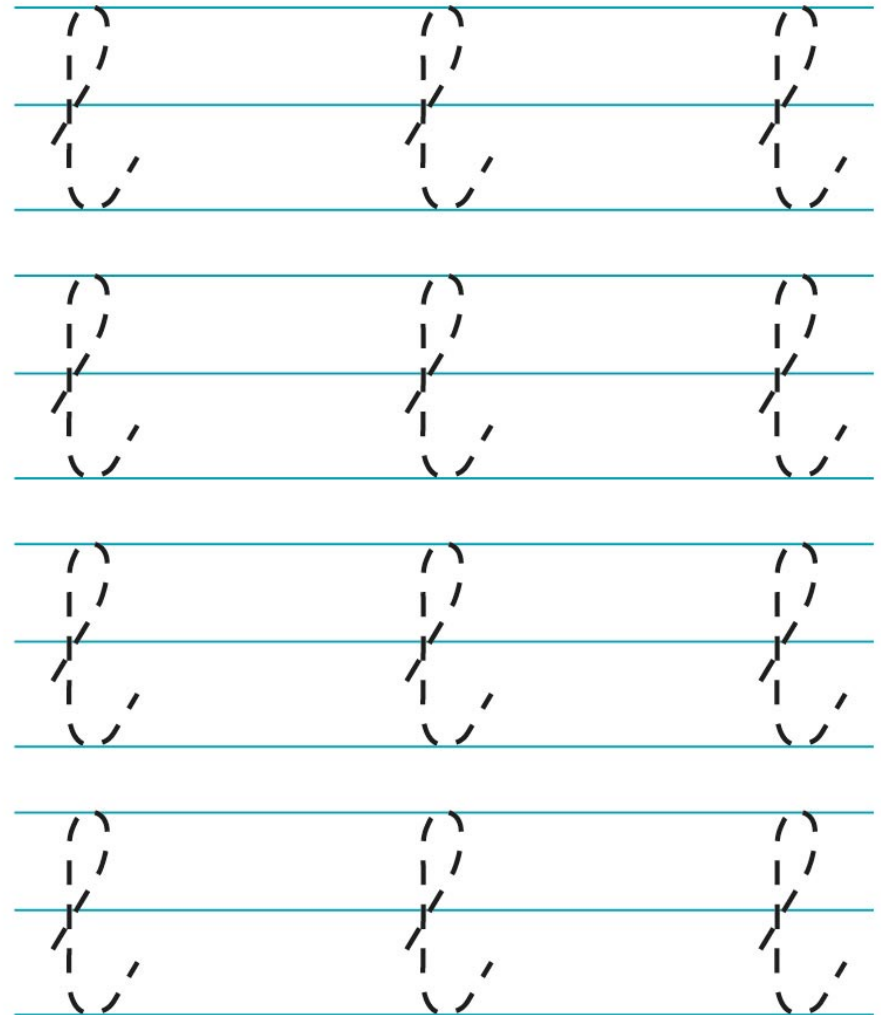
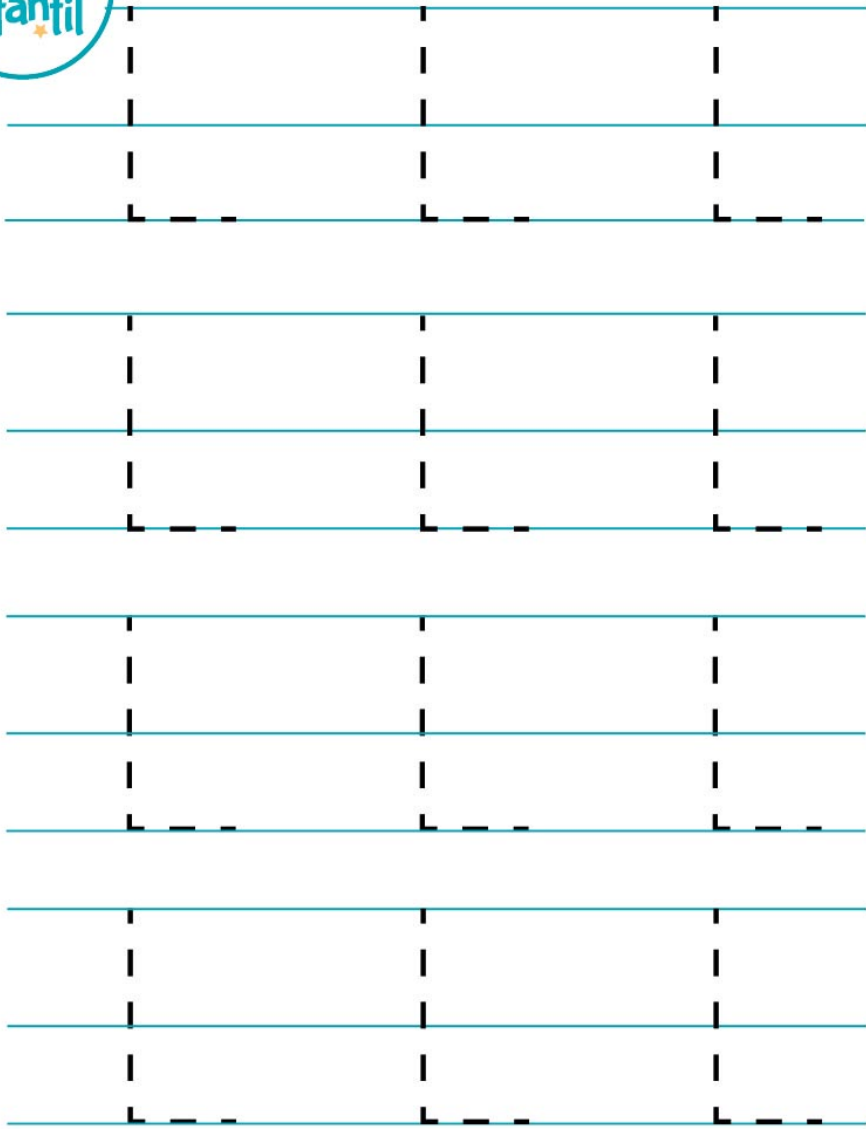

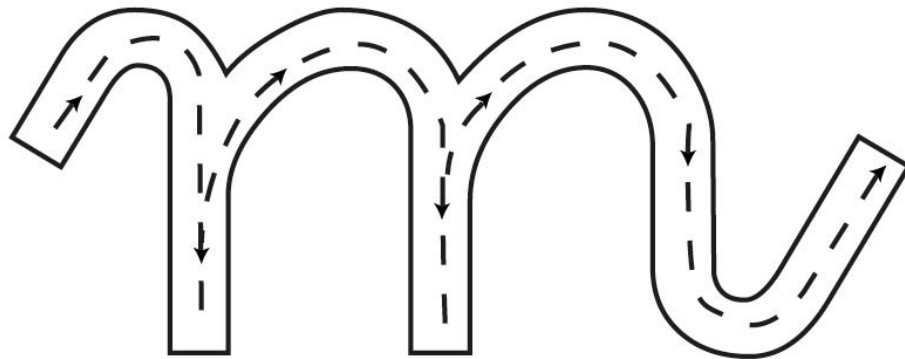
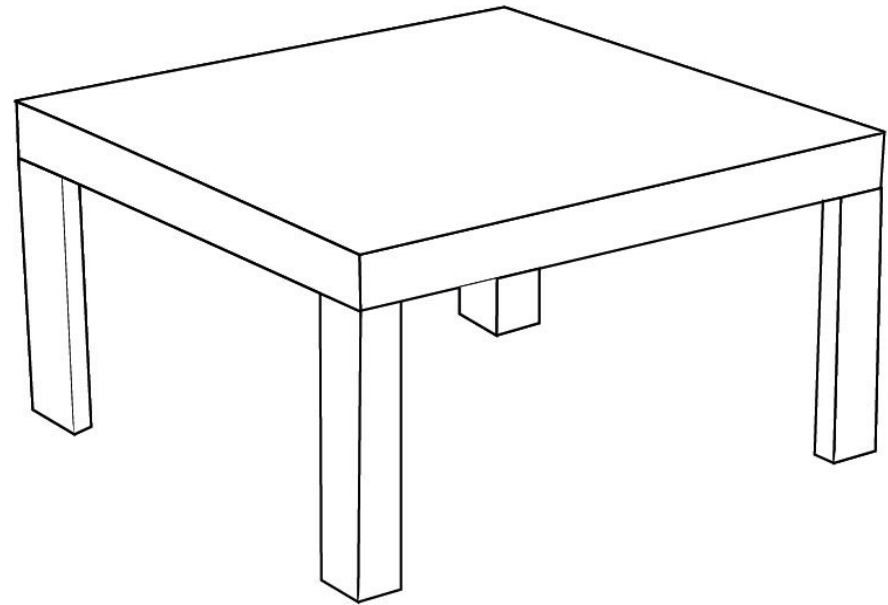
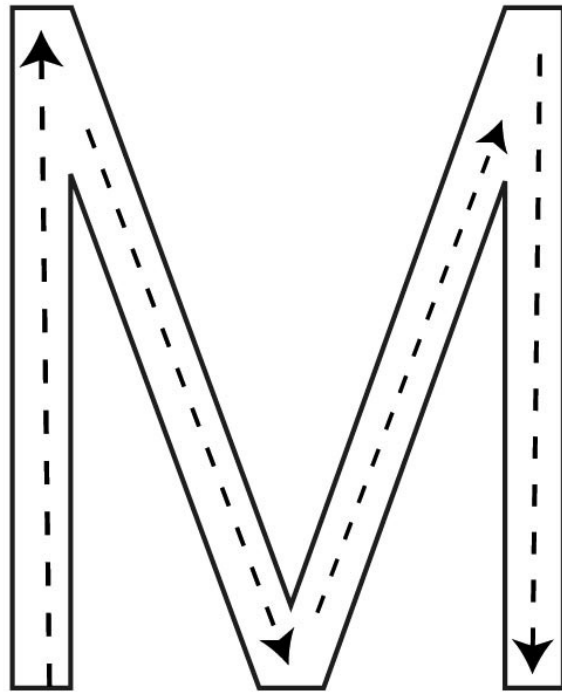

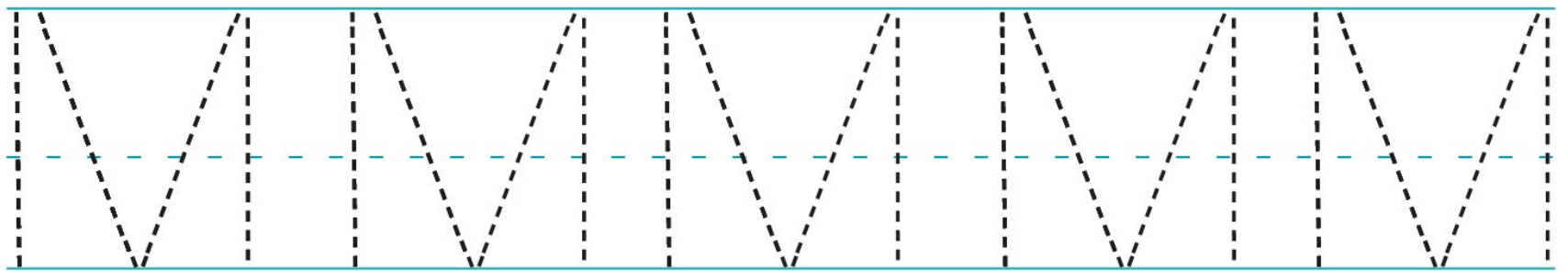
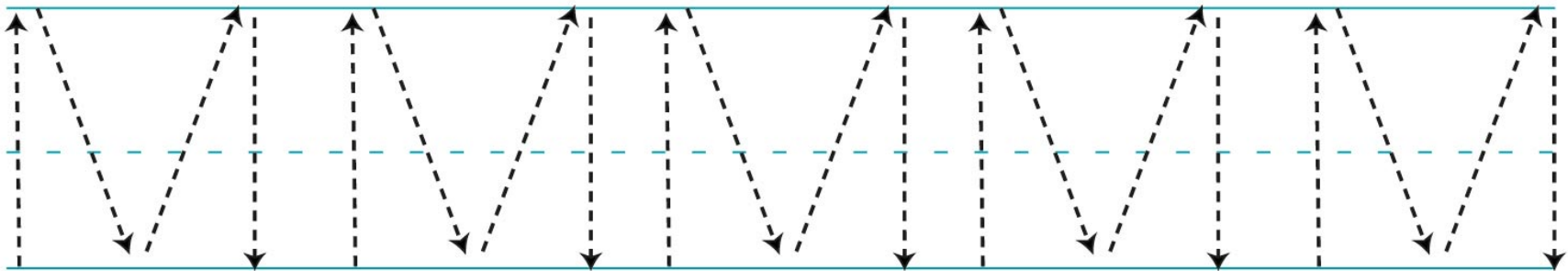
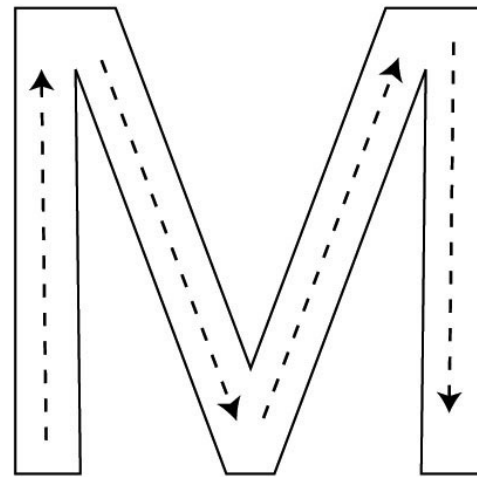
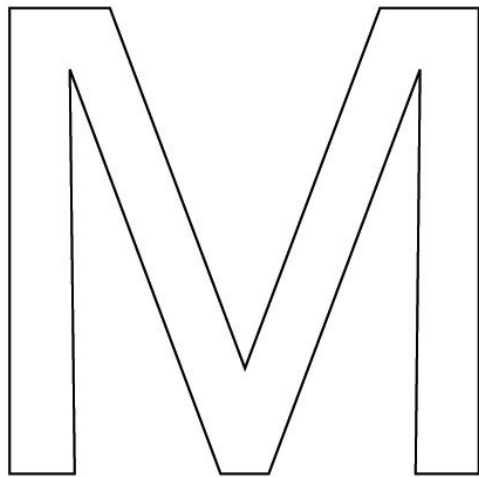

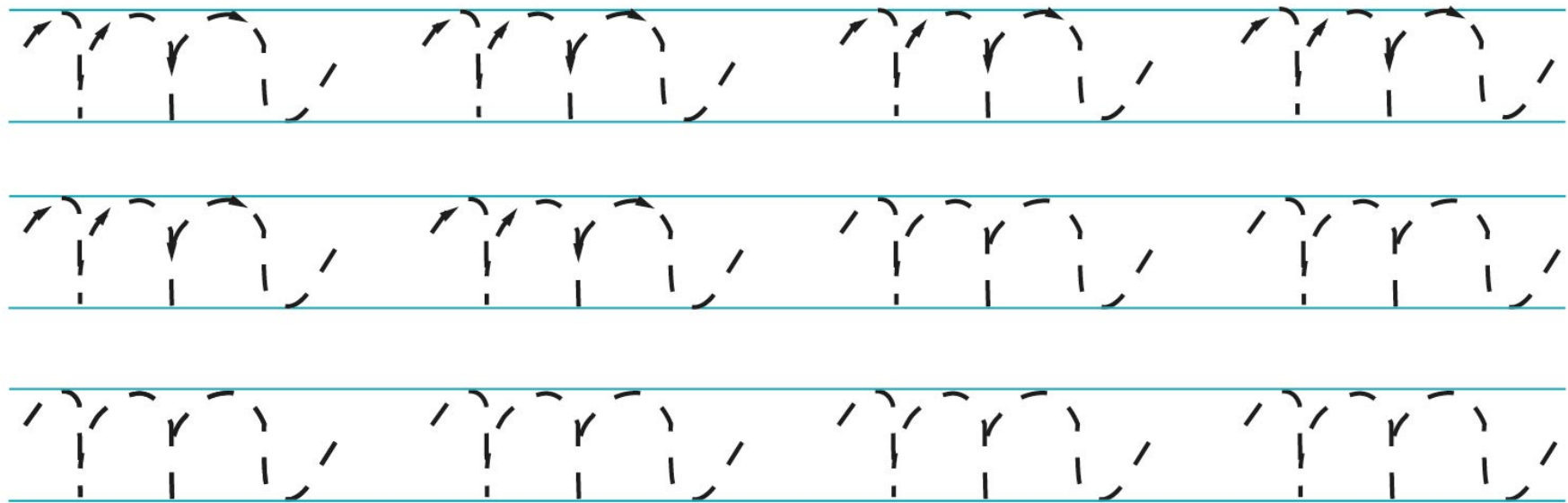
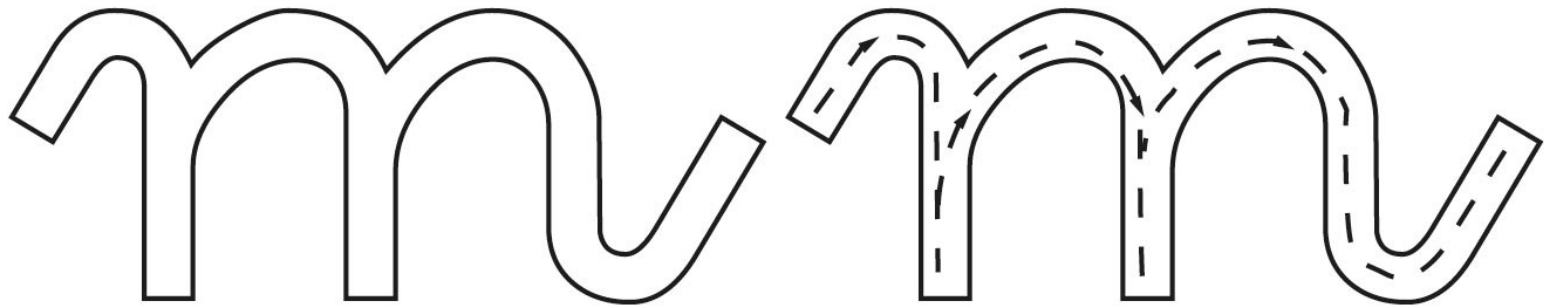

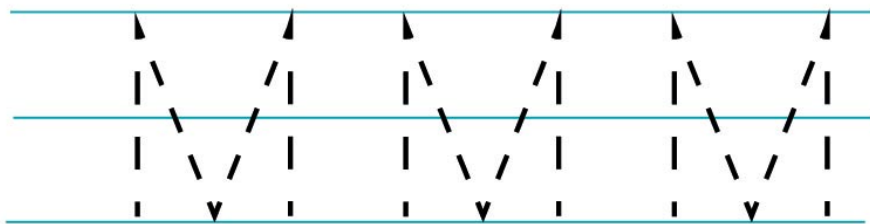
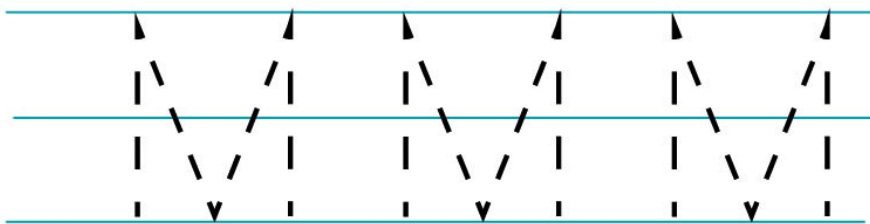

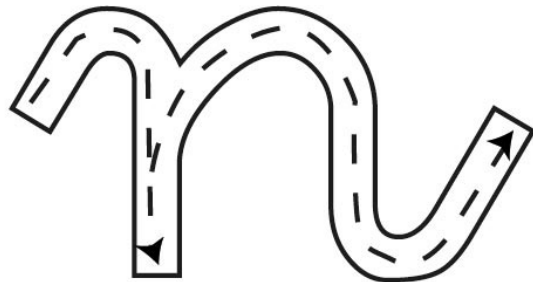
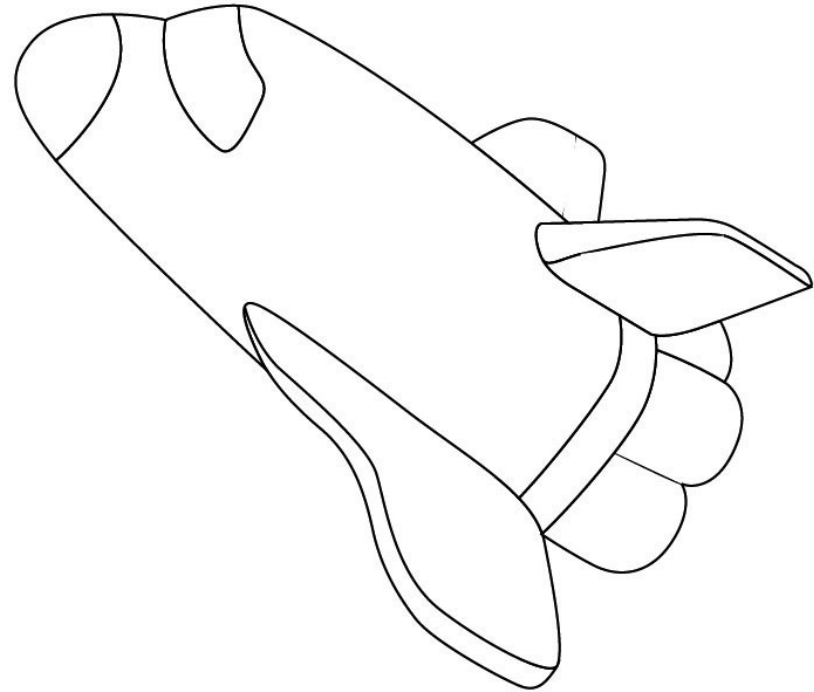
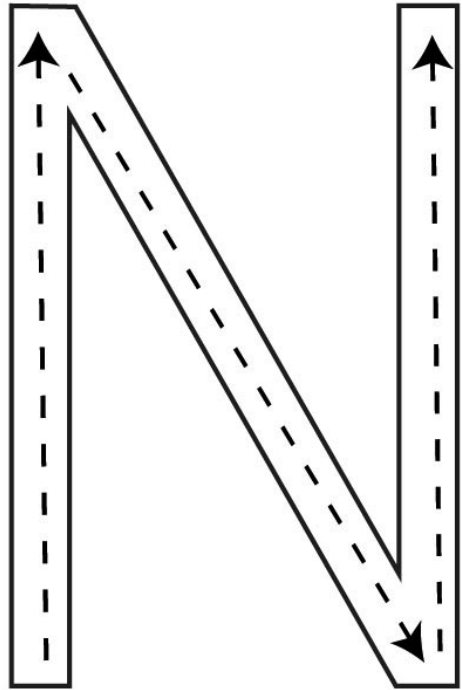

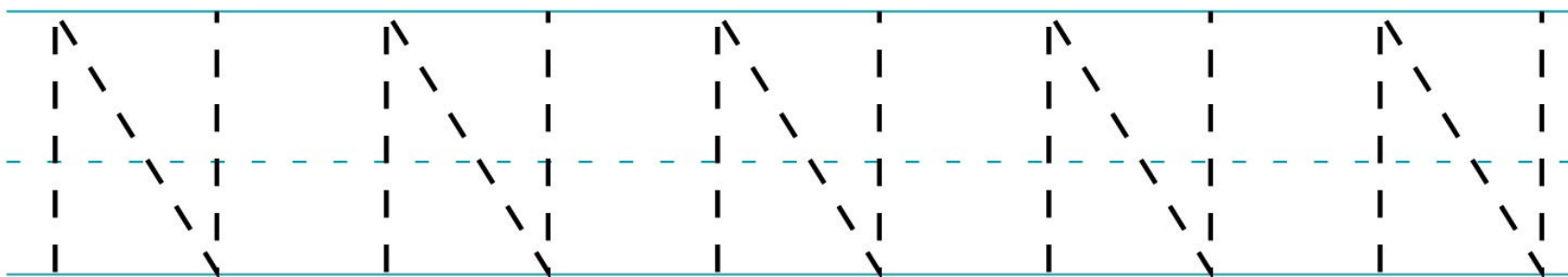
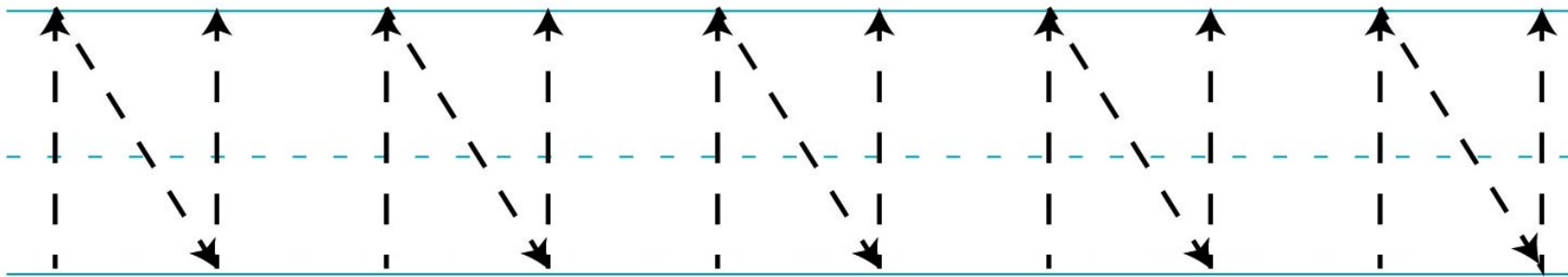
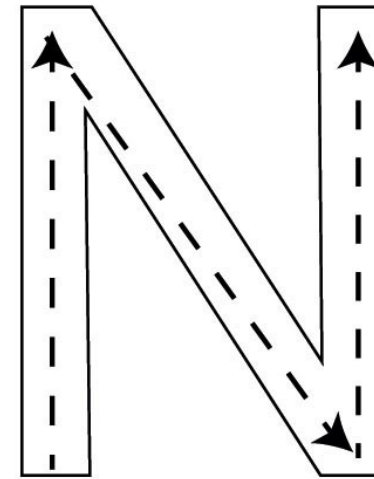
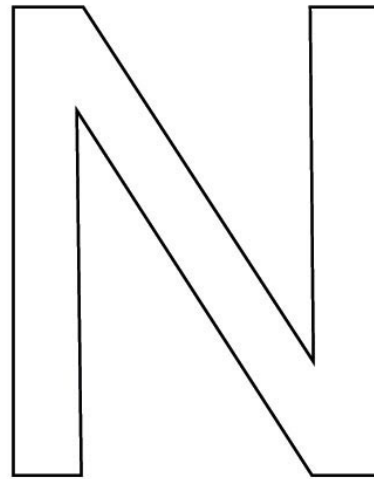

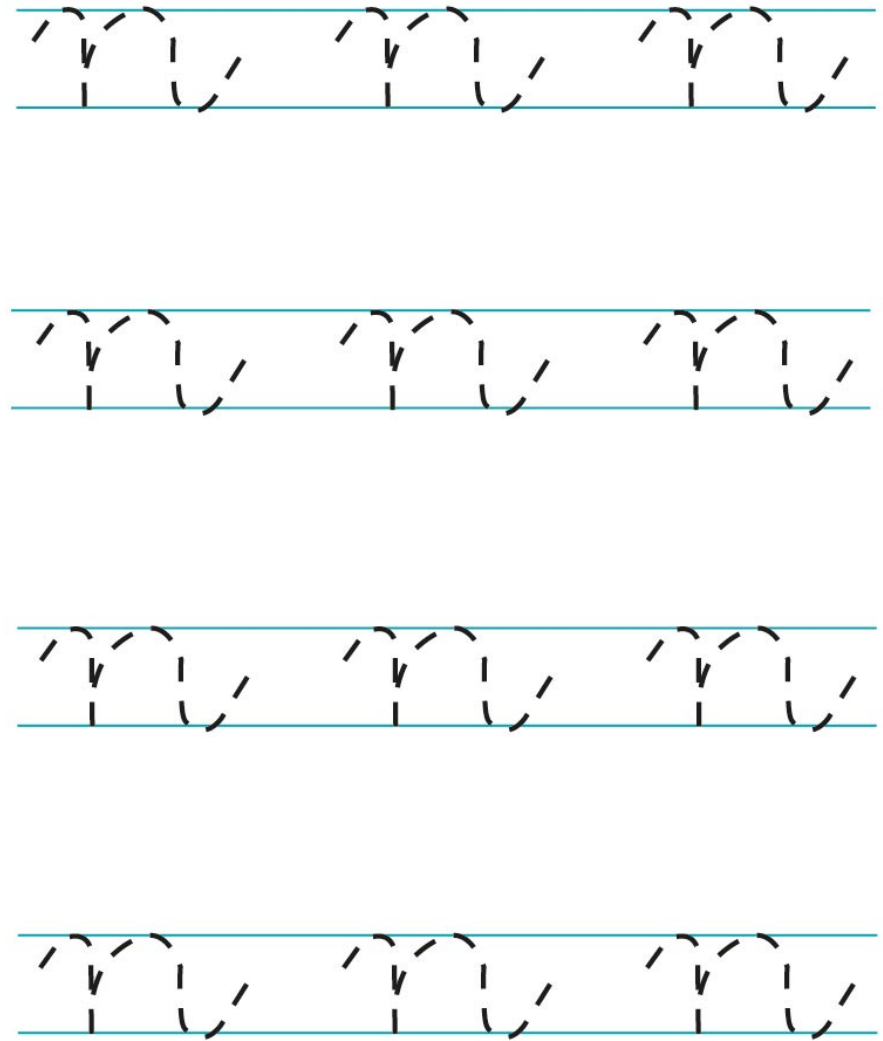
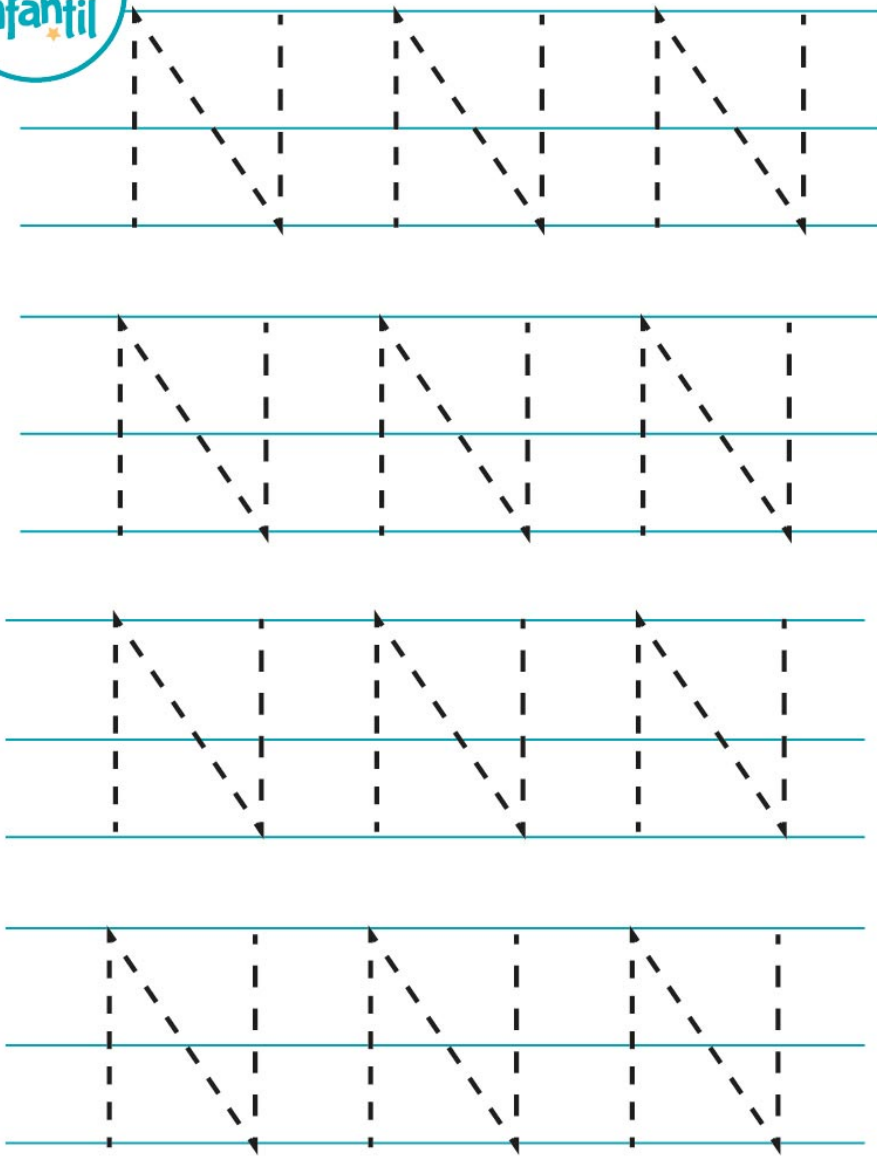

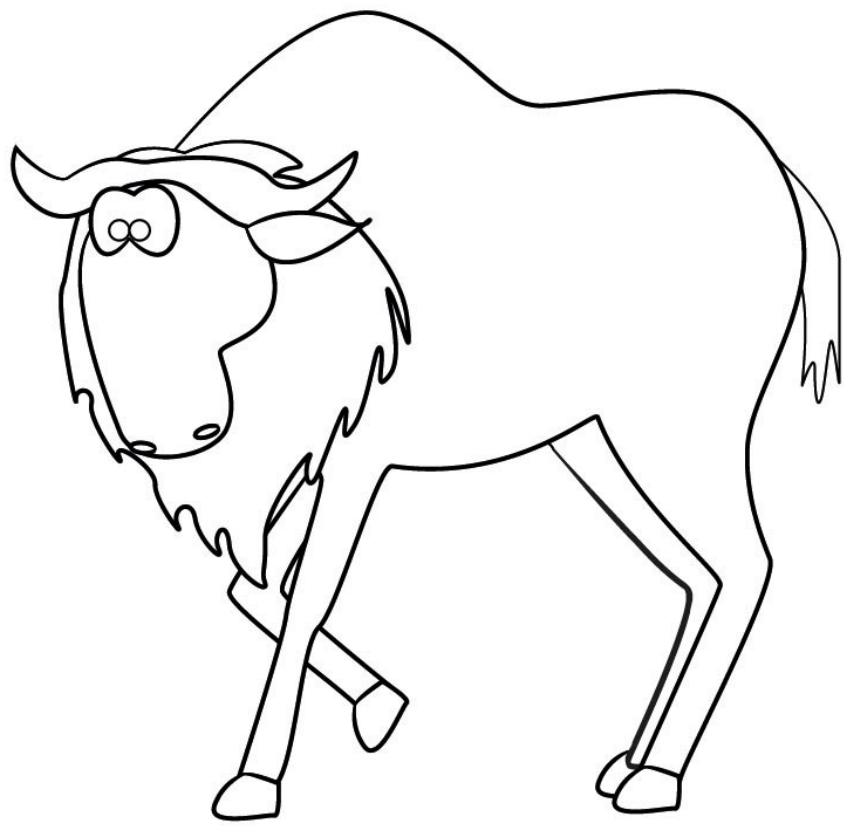
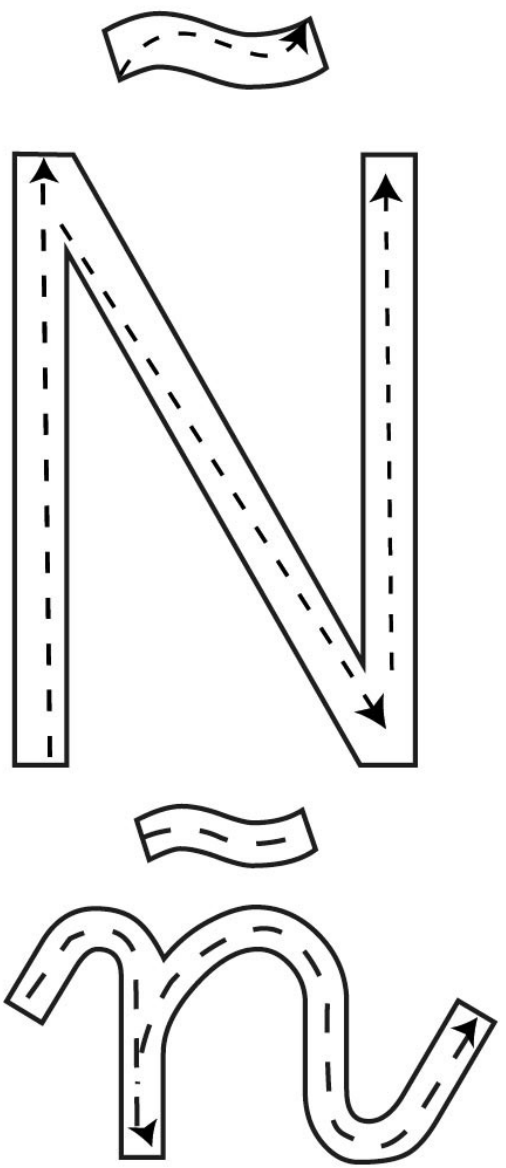

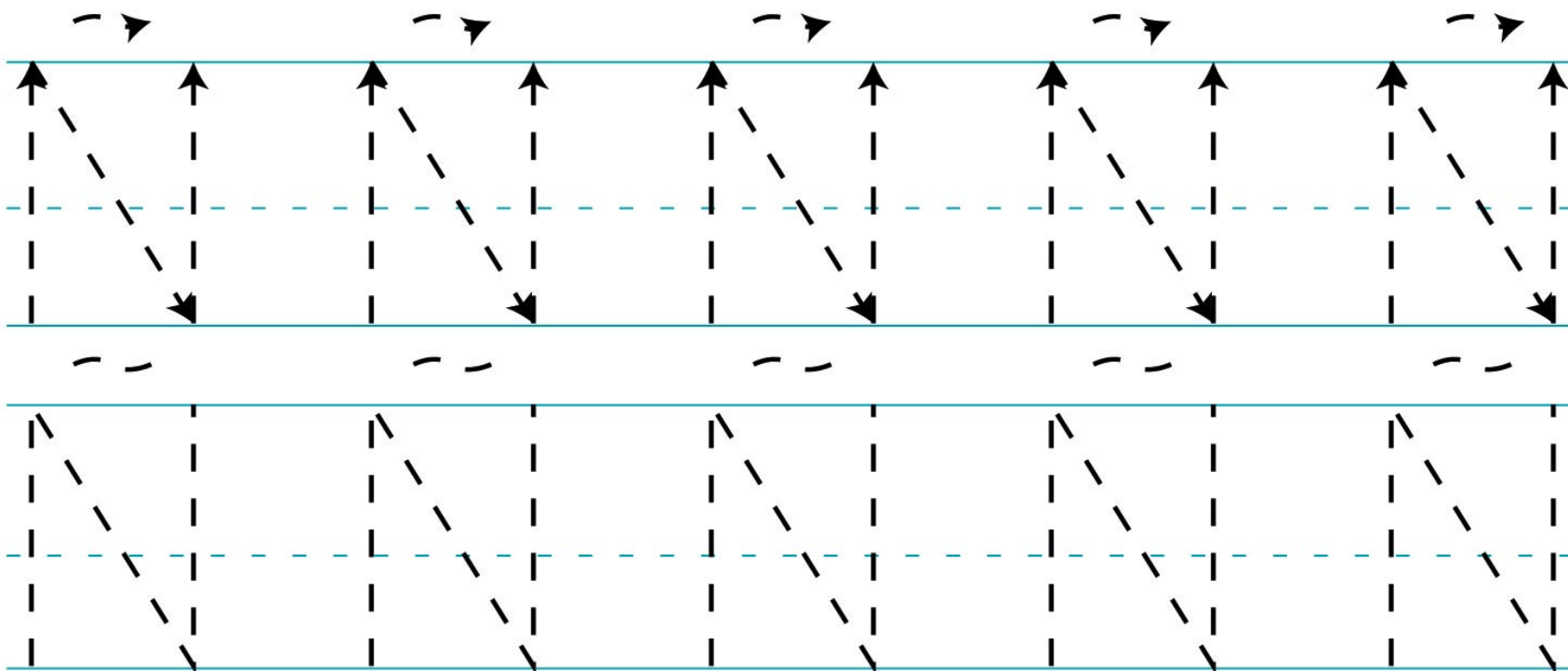
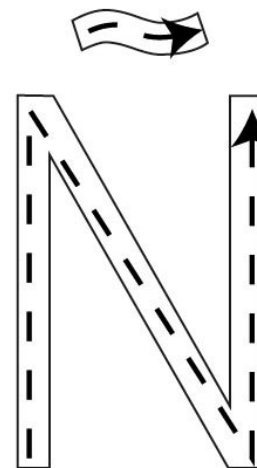
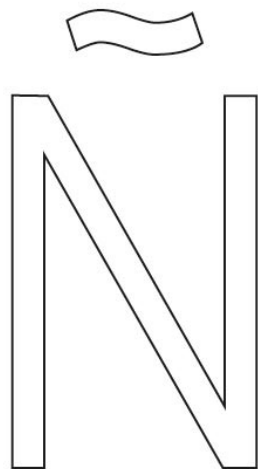

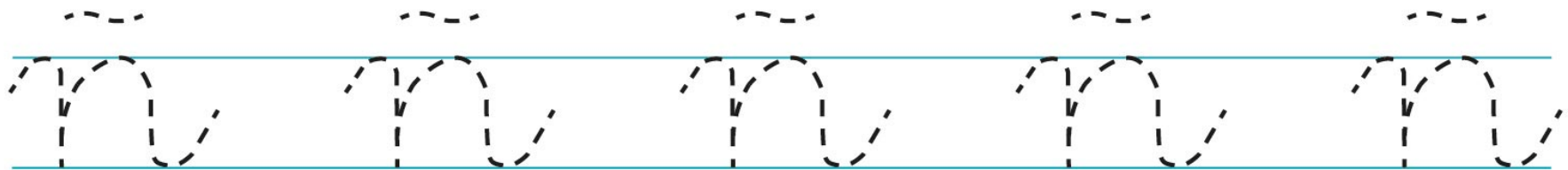
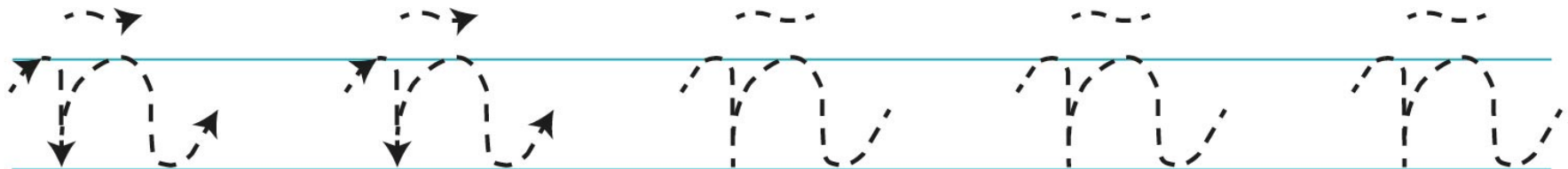
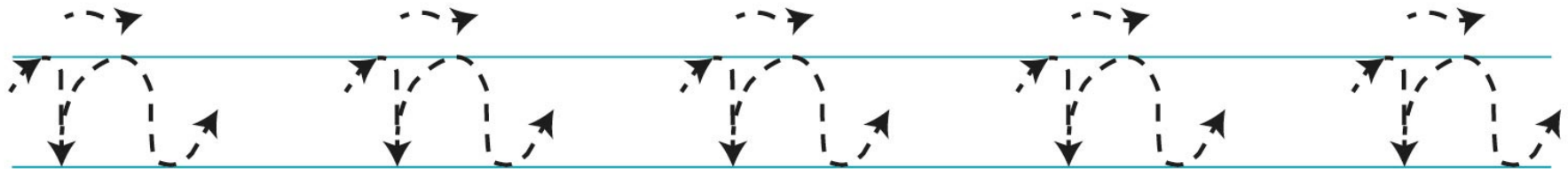
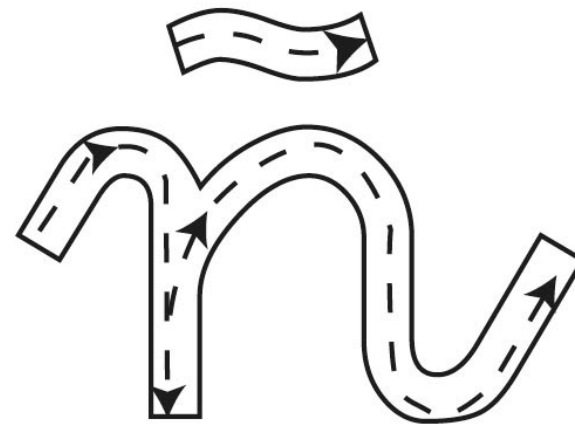
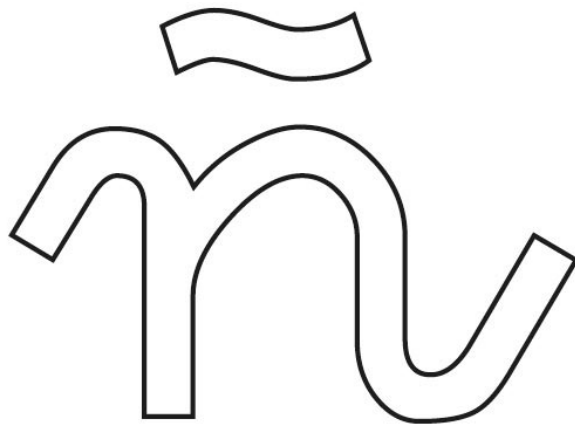

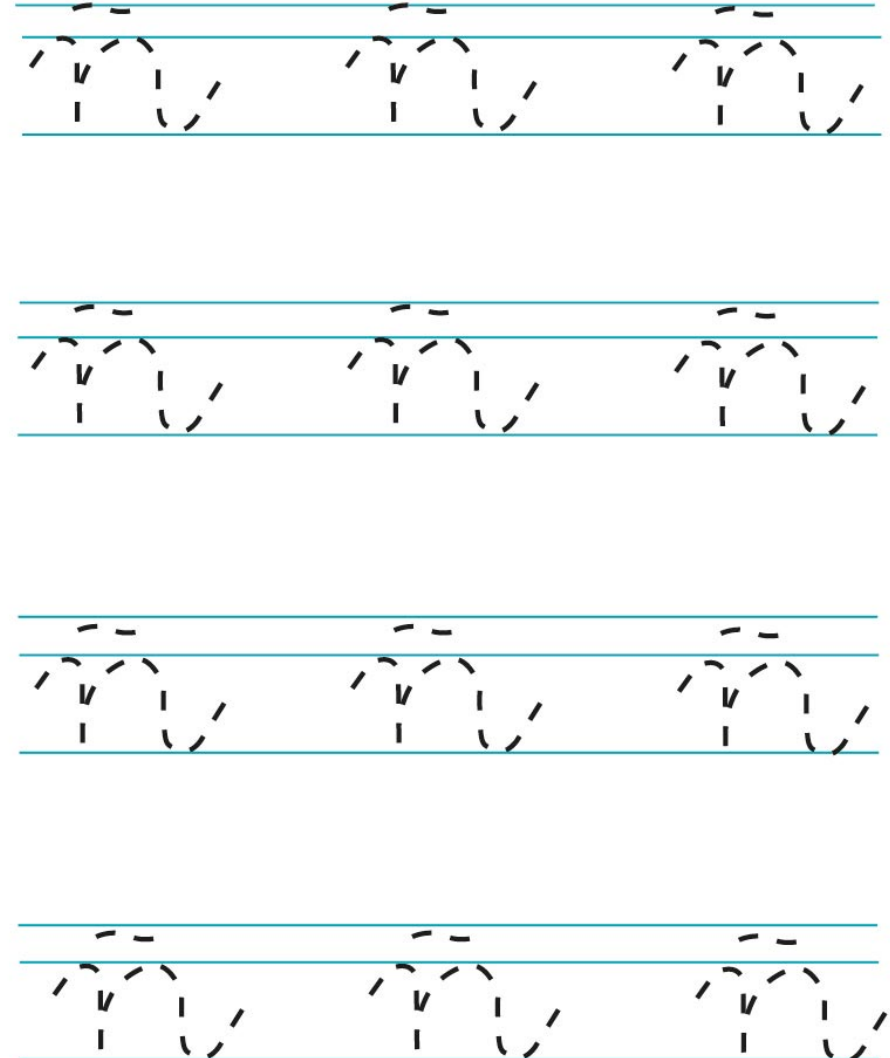
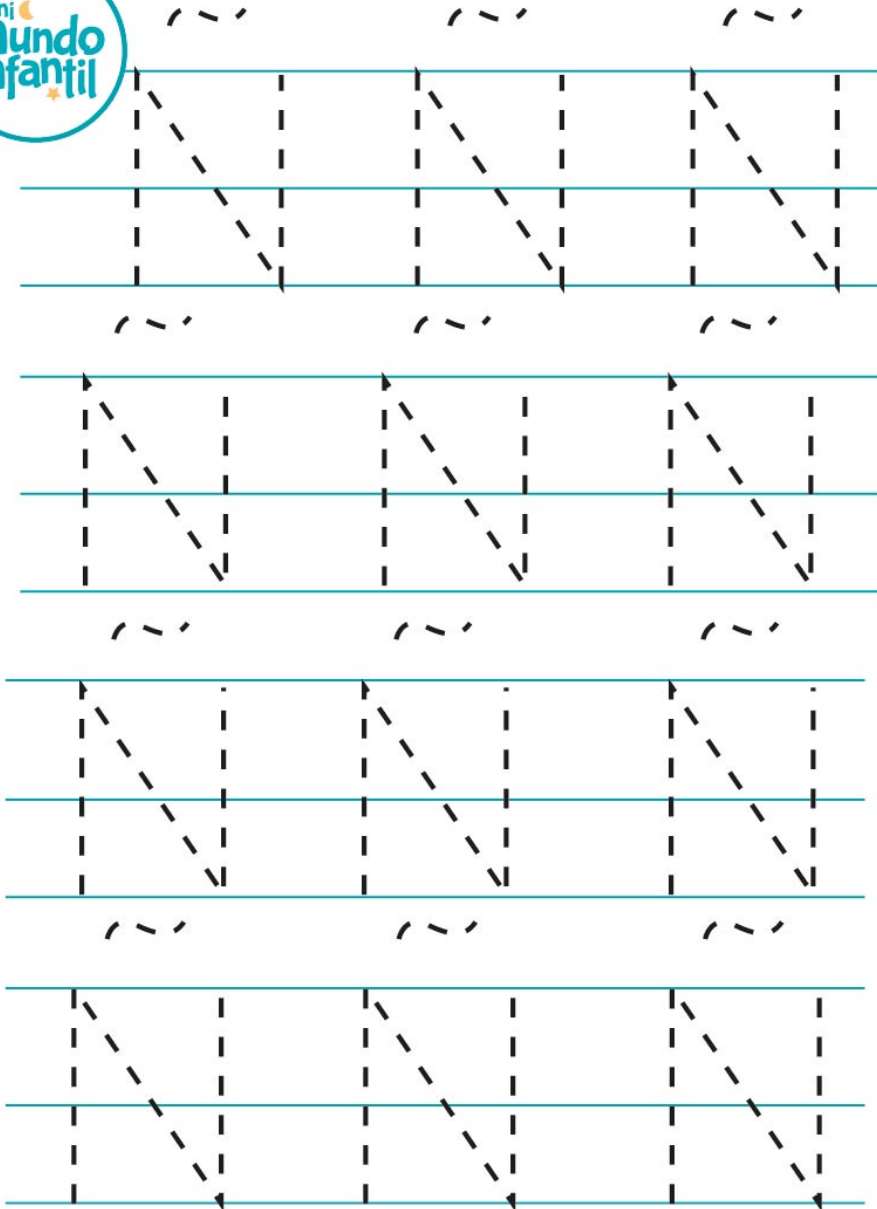

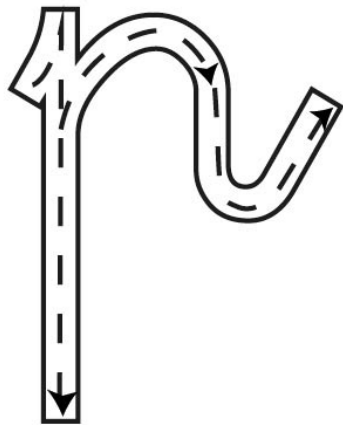
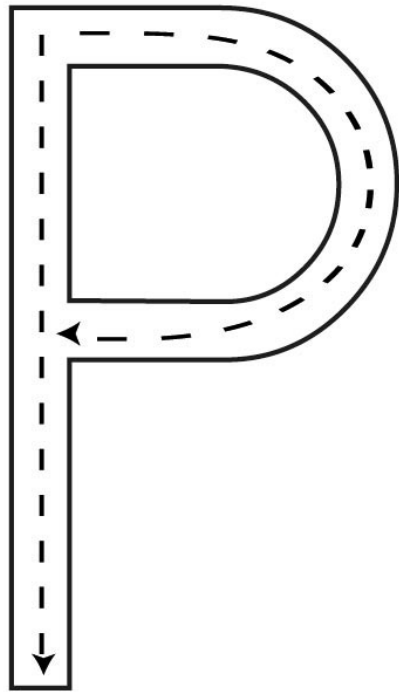

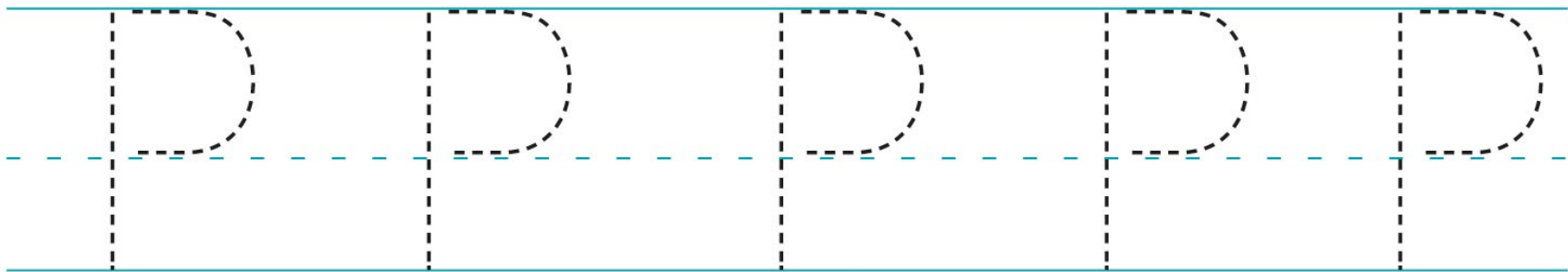
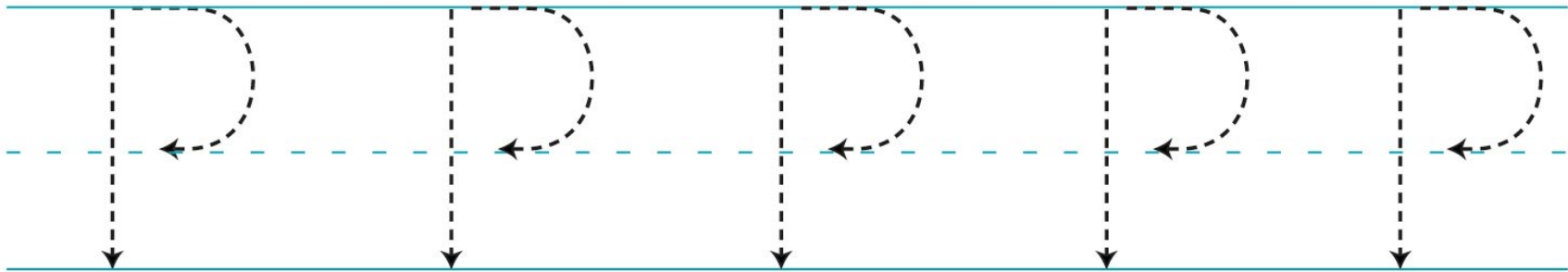
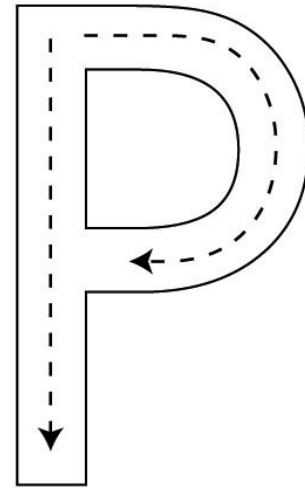
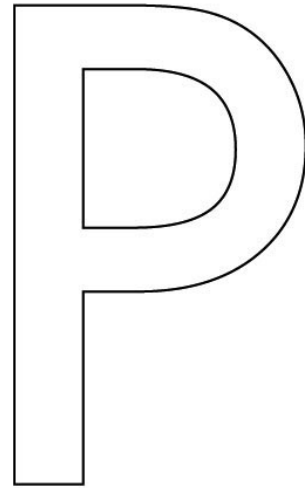

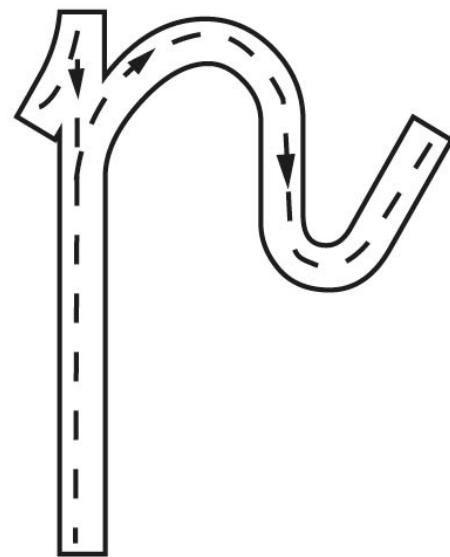
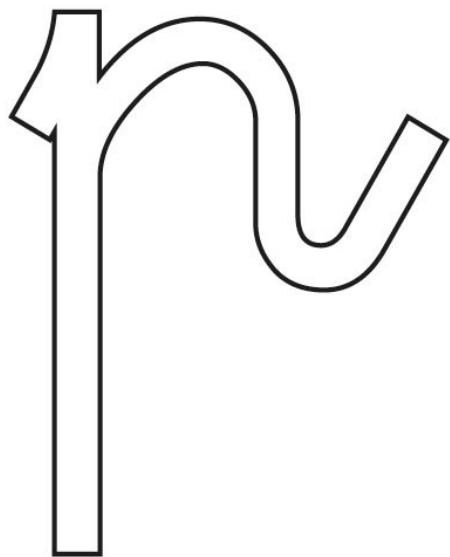

Tracing practice section with three rows of handwriting lines. Each row contains five dashed lowercase 'n' characters. The first row includes arrows indicating the stroke direction: a vertical line down, a vertical line up, and a curved line from top to bottom.

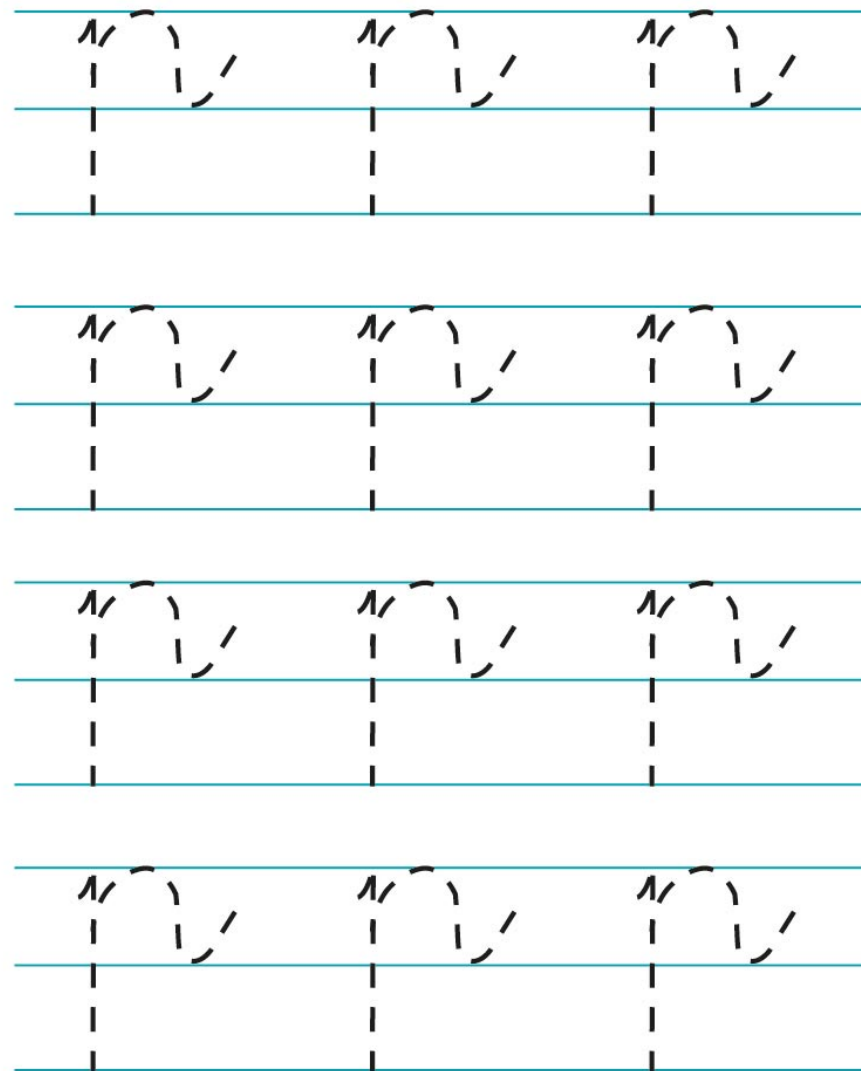
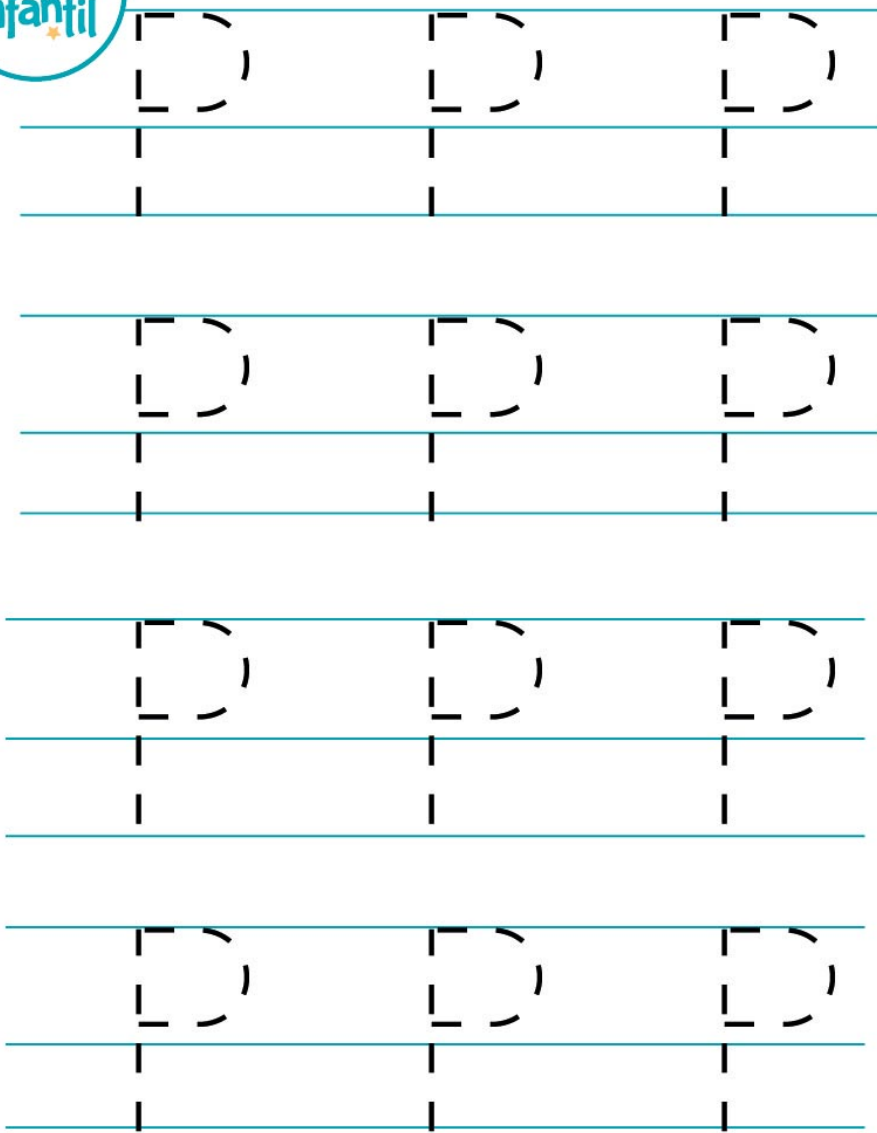

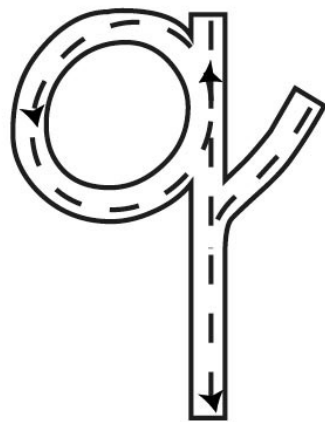
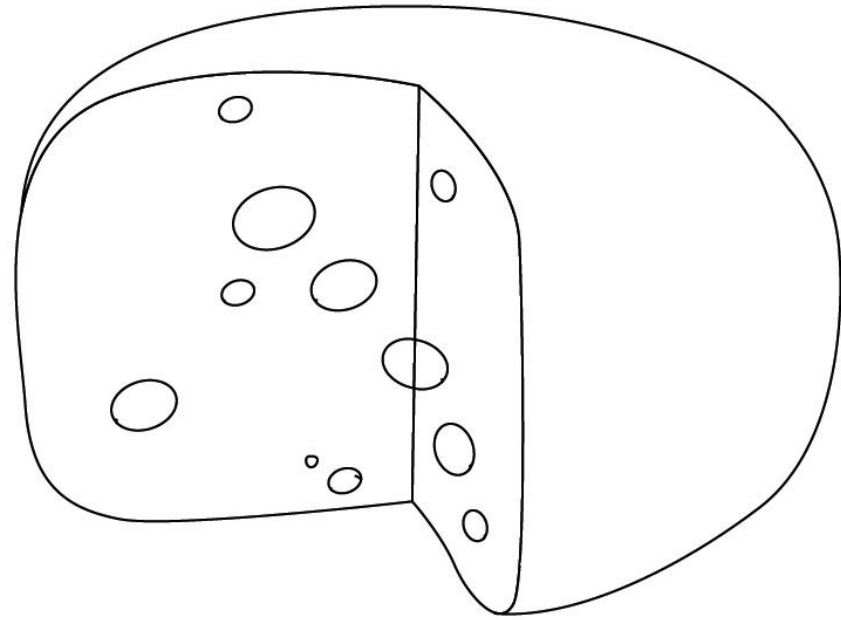
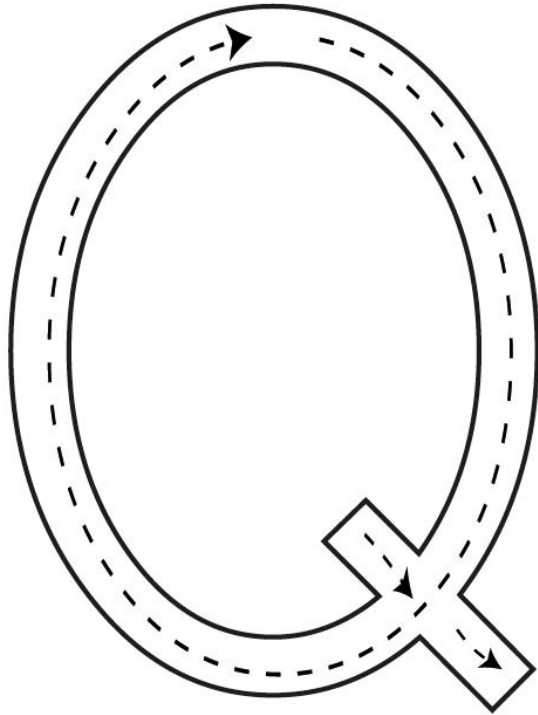

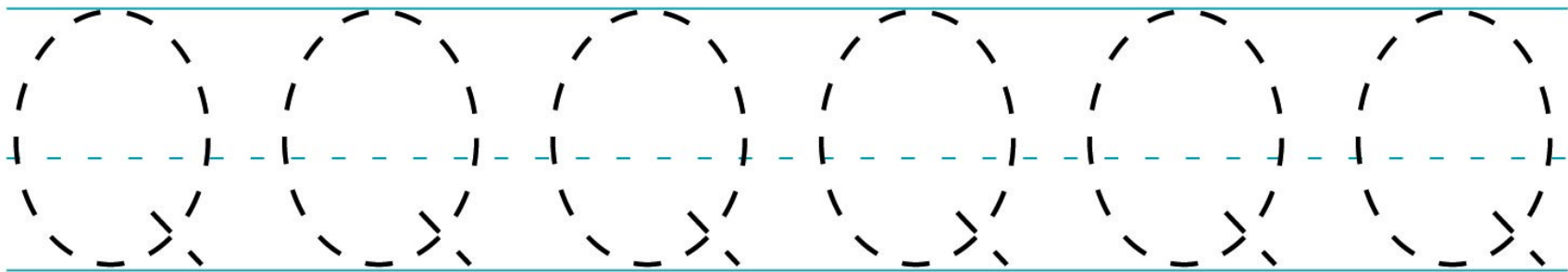
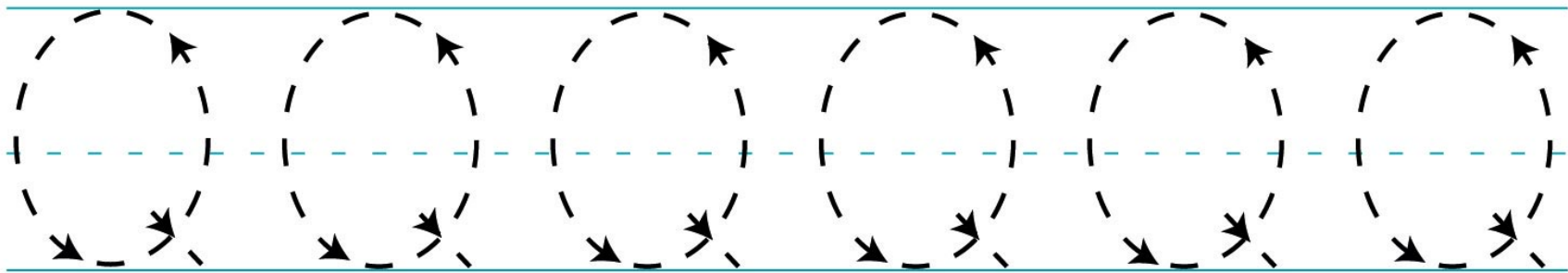
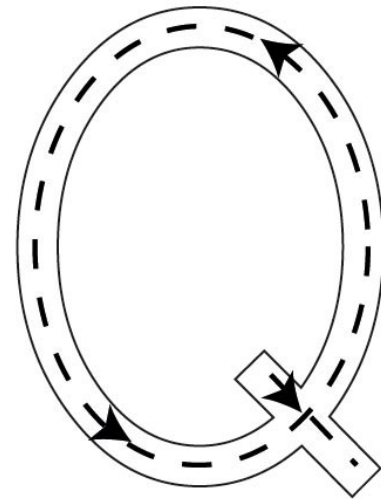
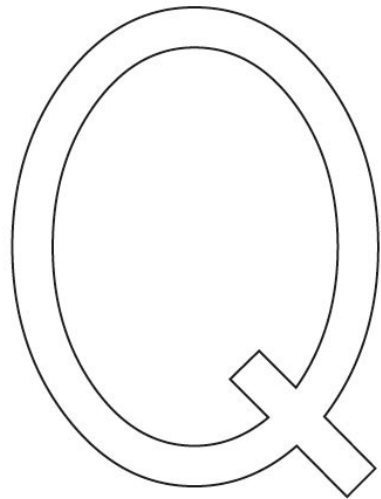

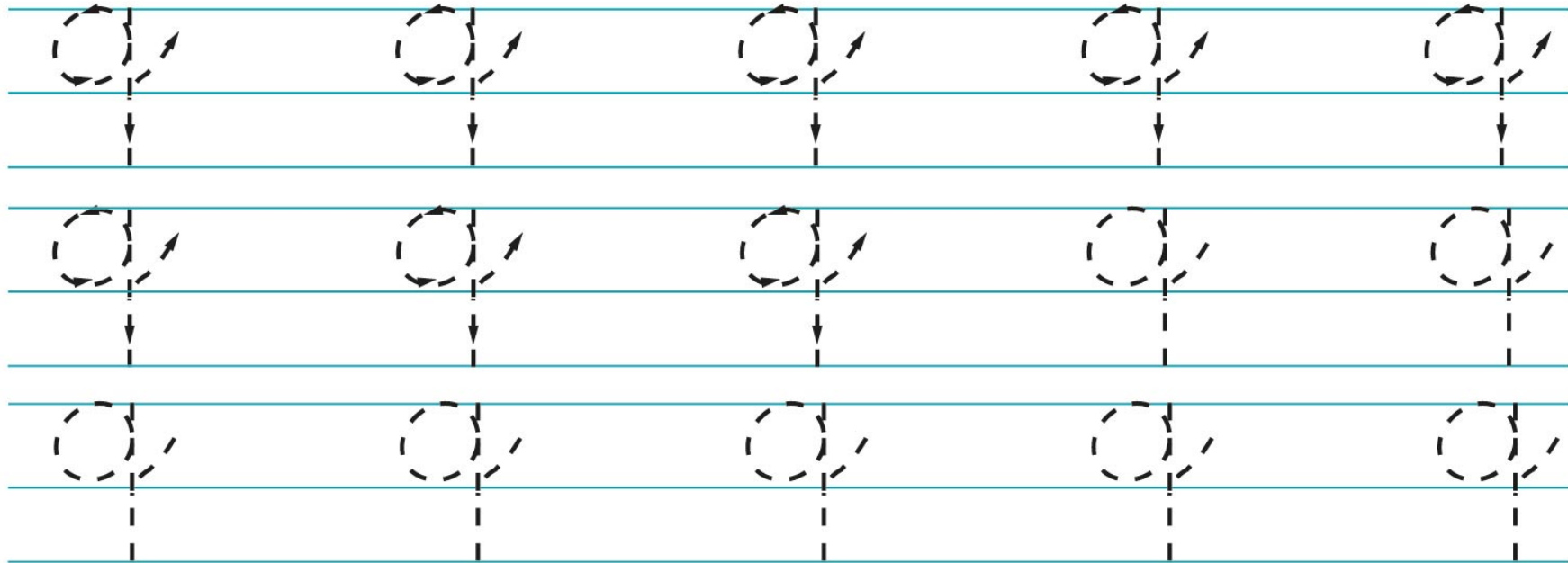
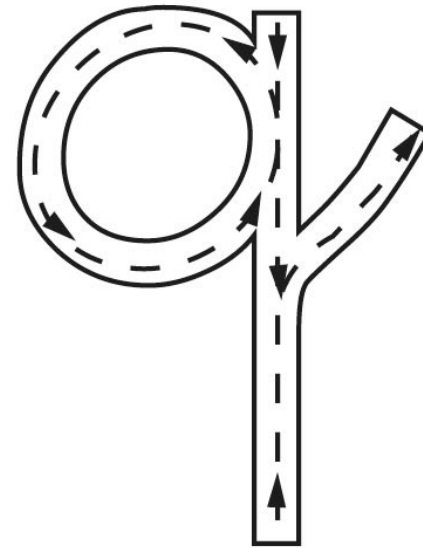
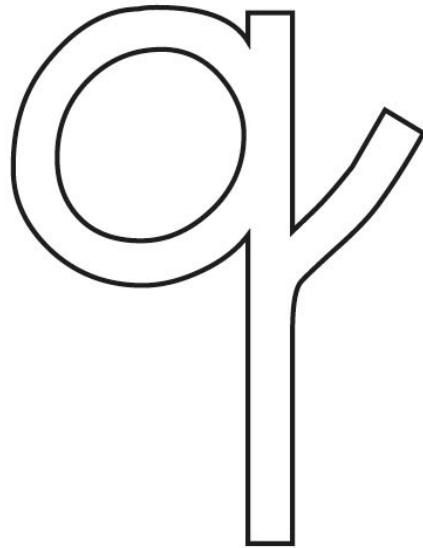

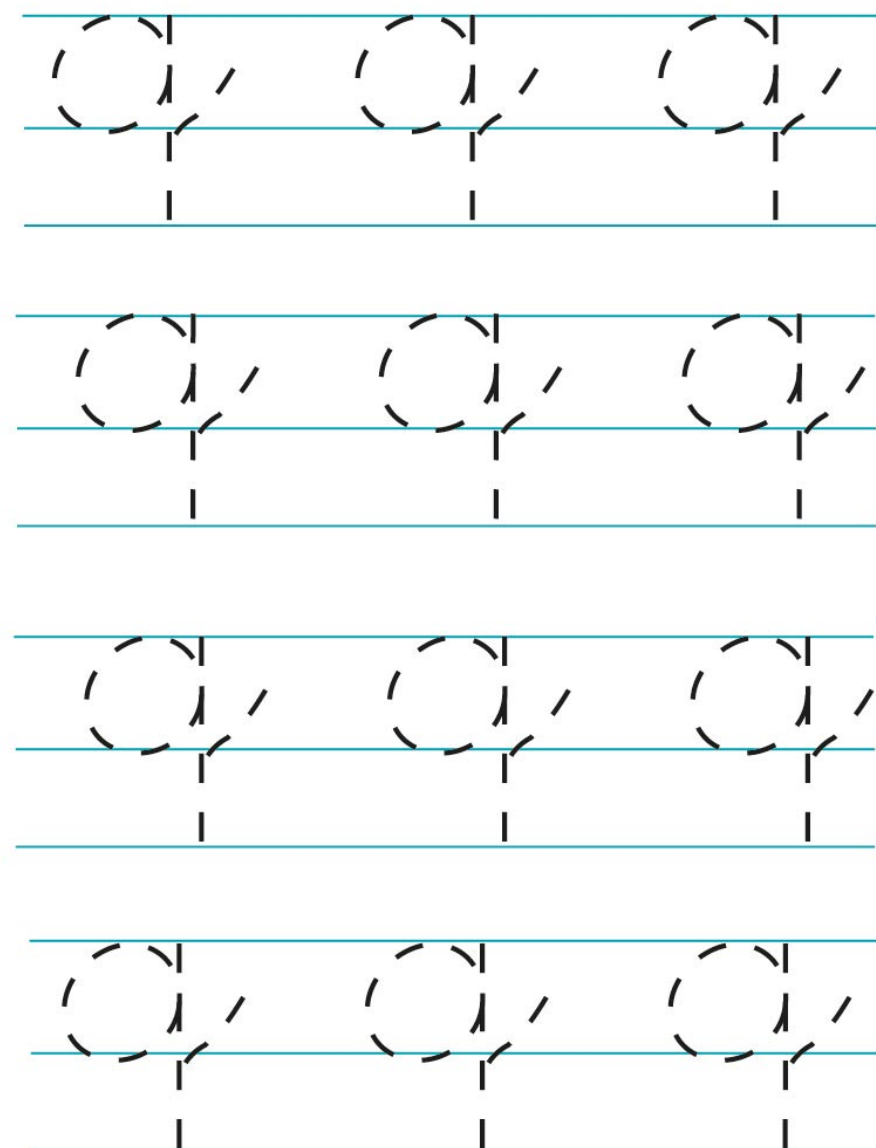
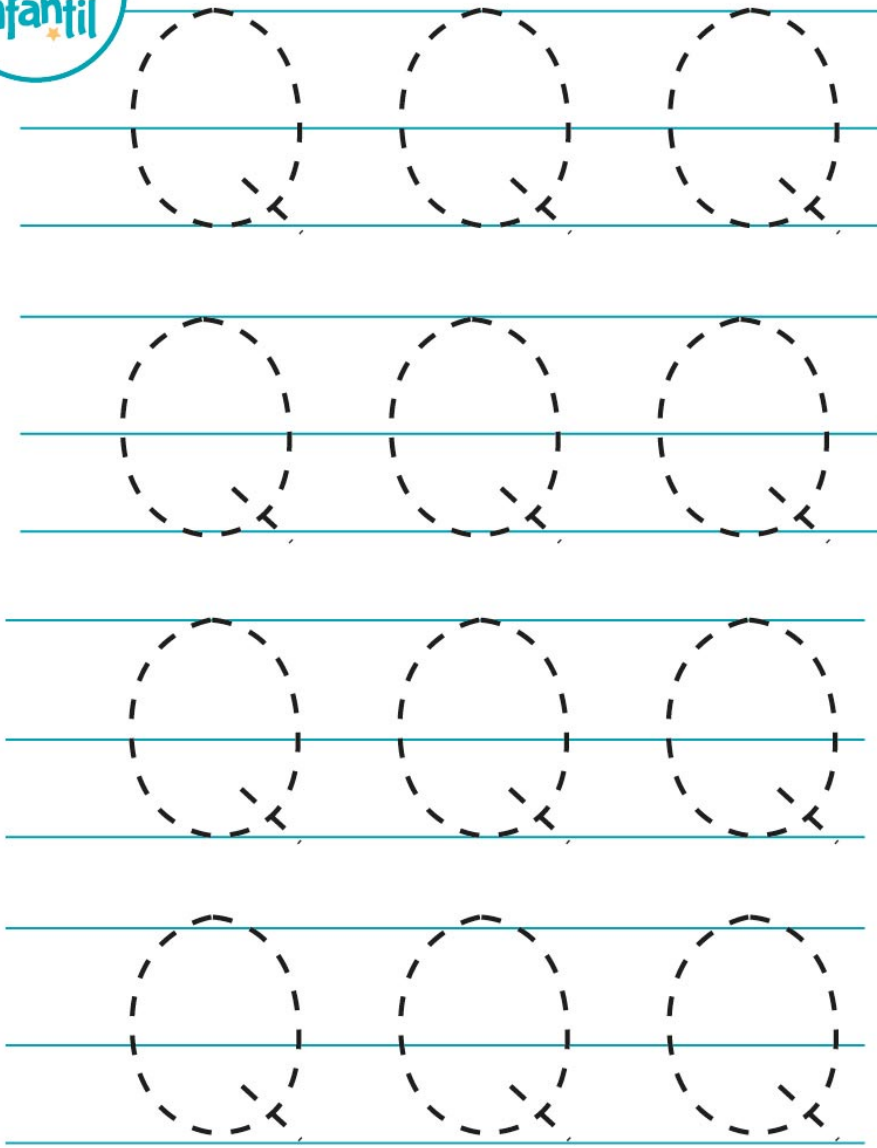

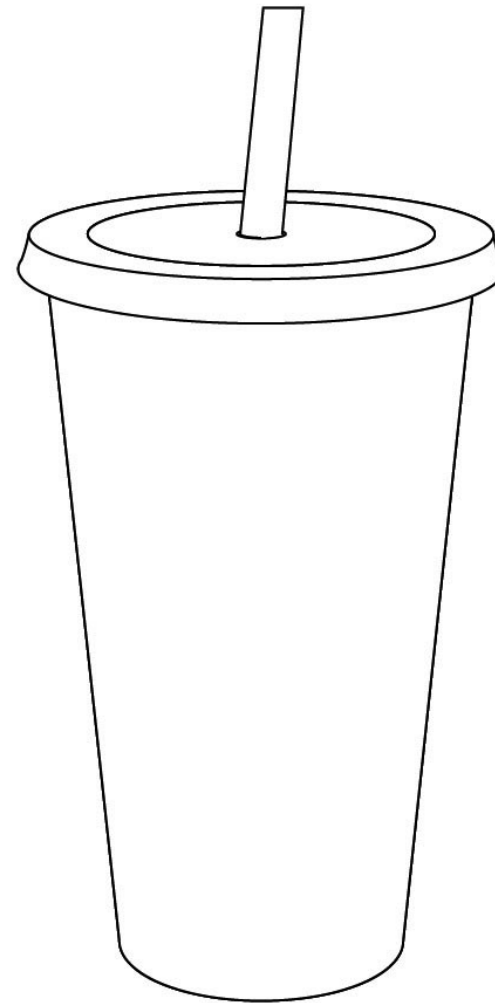
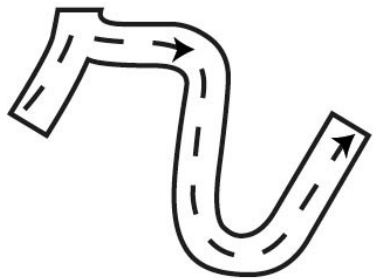
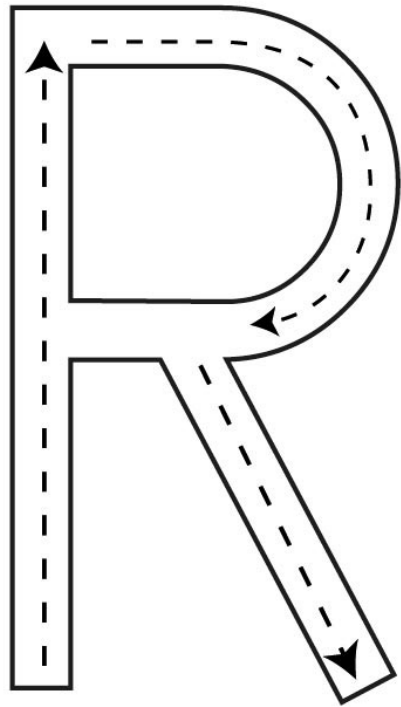

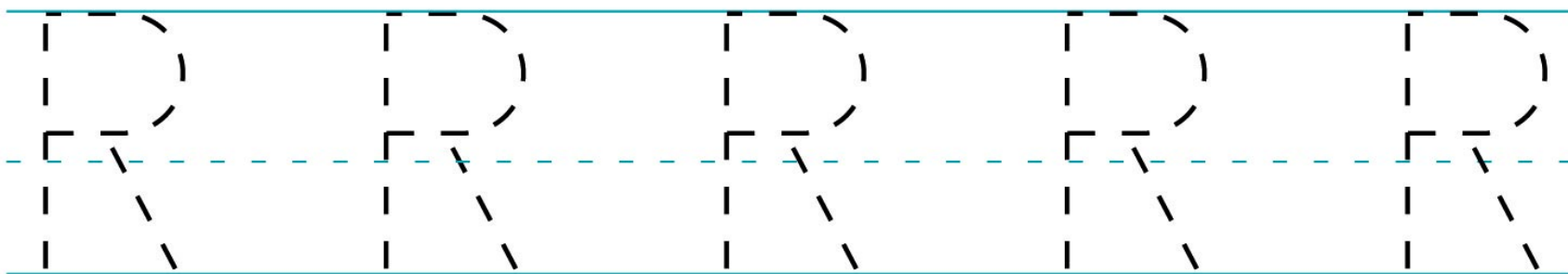
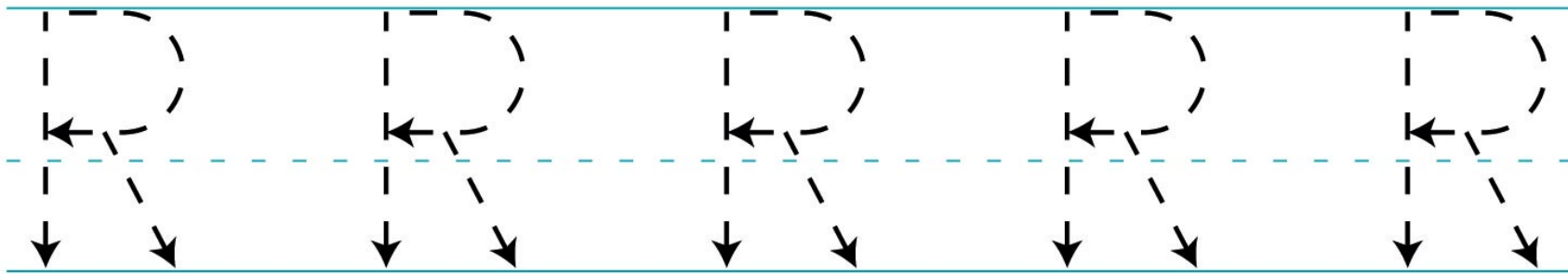
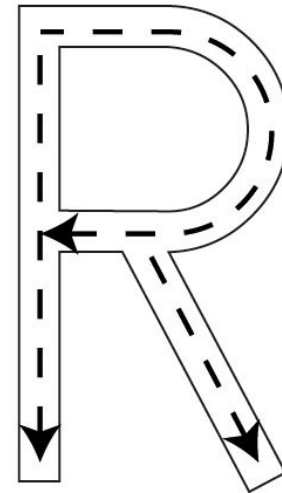
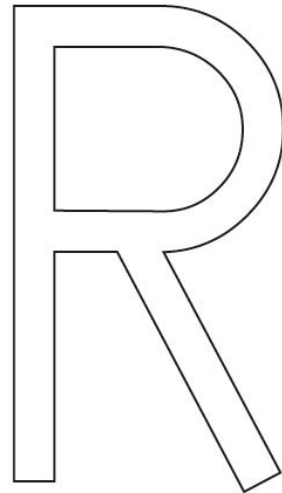

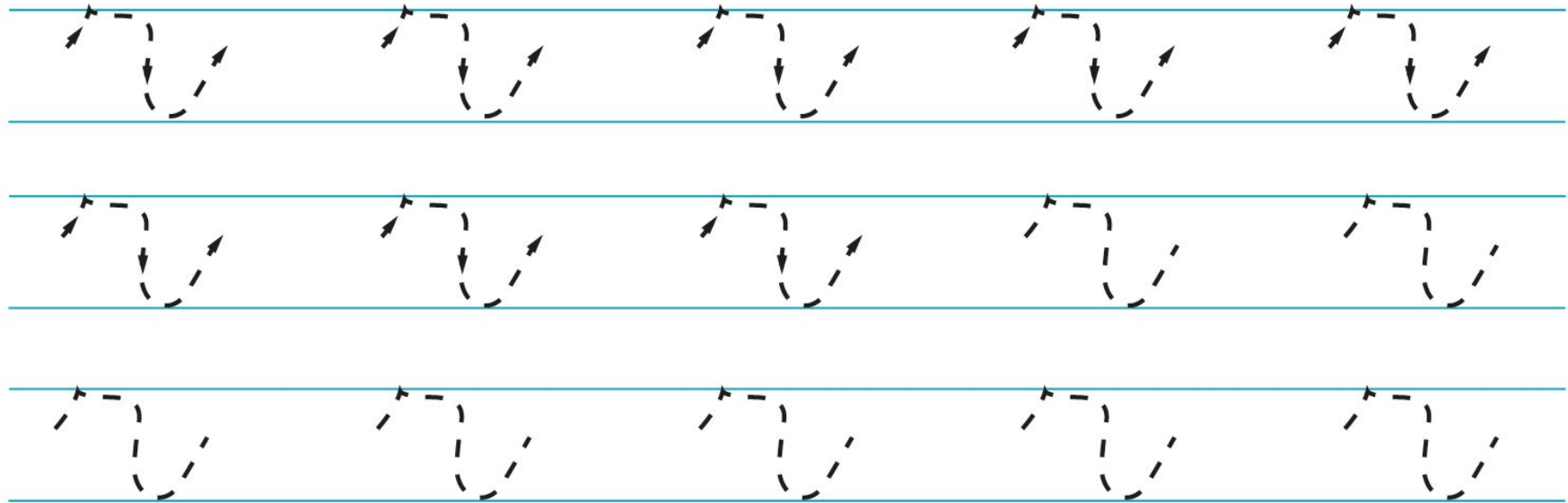
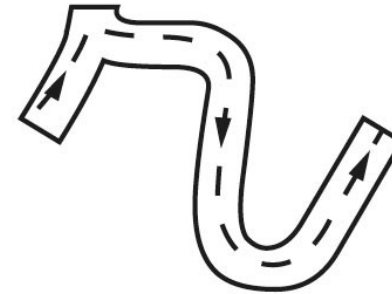
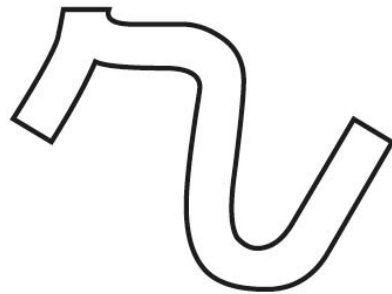

R R R

R R R

R R R

R R R

r r r

r r r

r r r

r r r

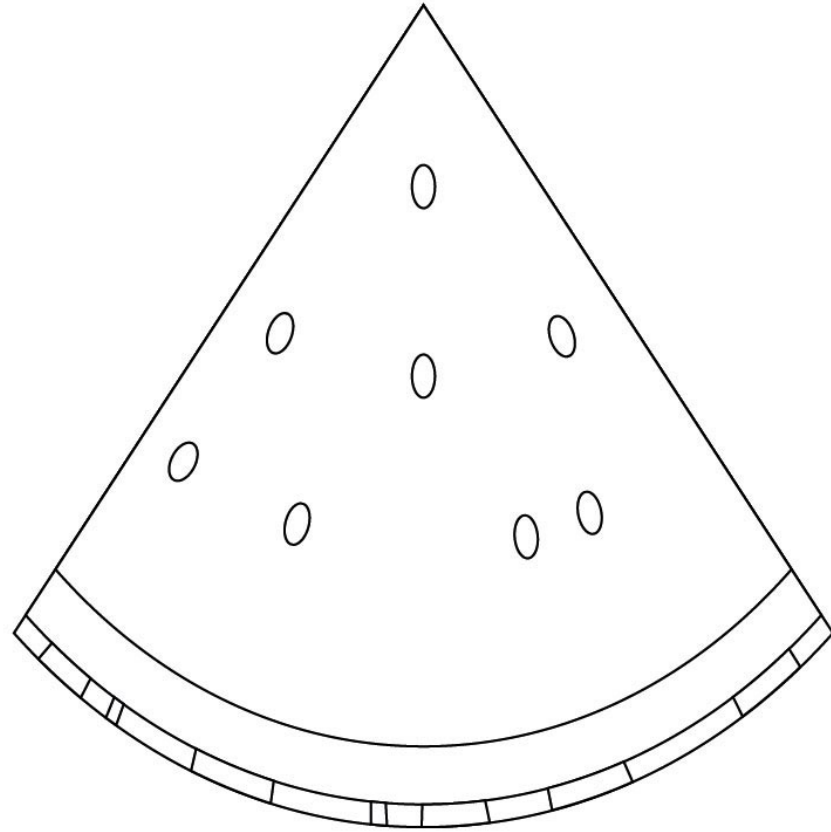
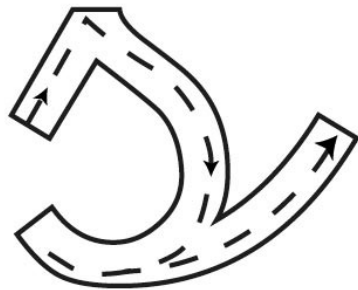
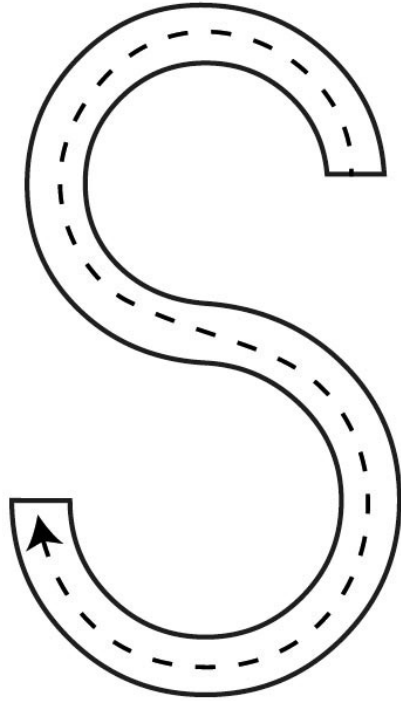

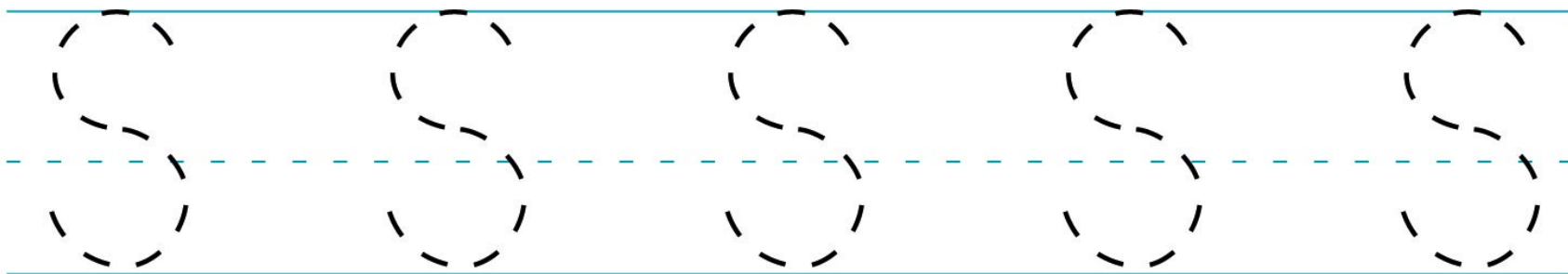
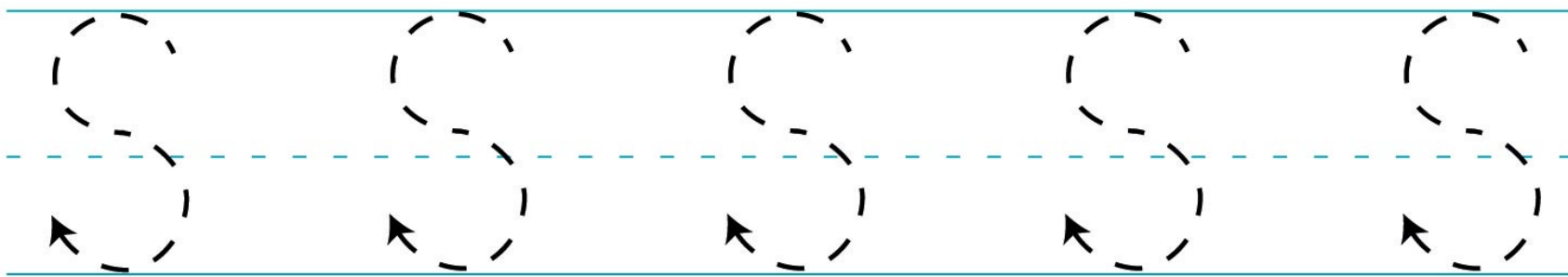
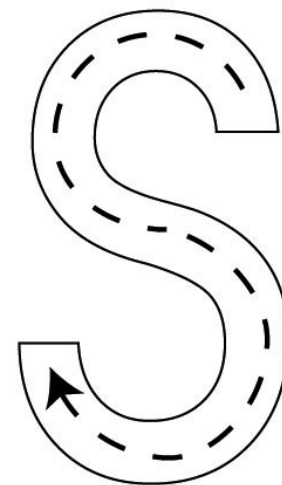
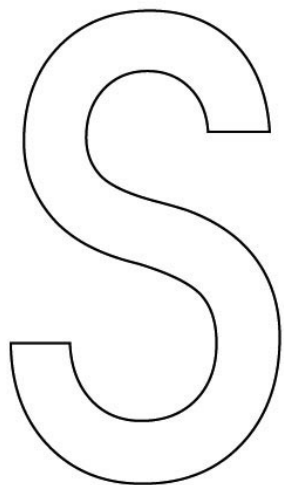

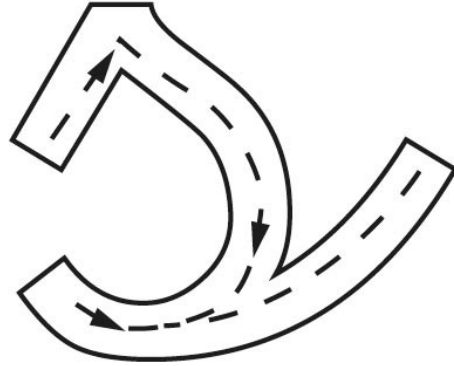
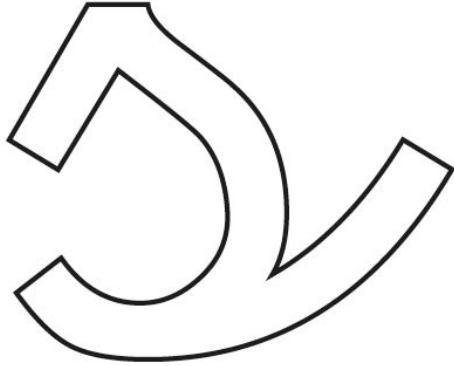

Tracing practice area consisting of three rows of horizontal lines. Each row contains five dashed outlines of the letter '3' for tracing. The first row shows the letter between two lines. The second row shows the letter between two lines with a dashed line extending from the bottom curve. The third row shows the letter between two lines with a dashed line extending from the bottom curve at a different angle.

S S S

S S S

S S S

S S S

S S S

S S S

S S S

S S S

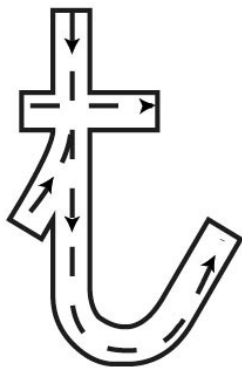
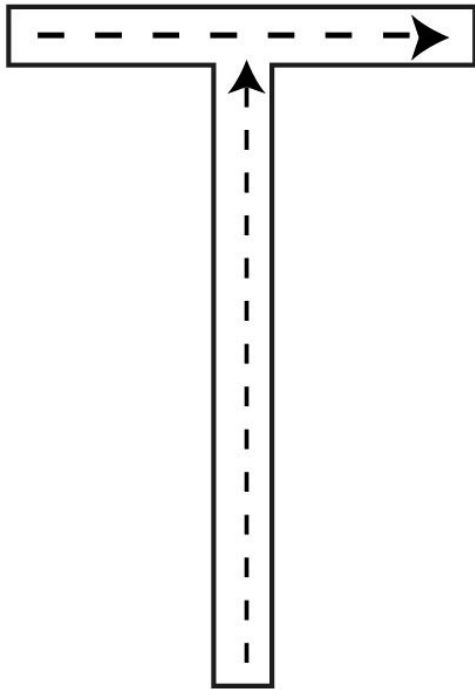

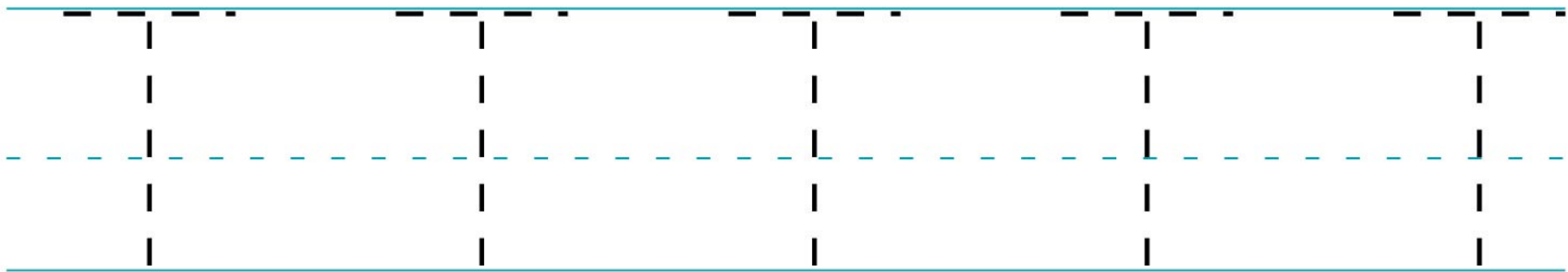
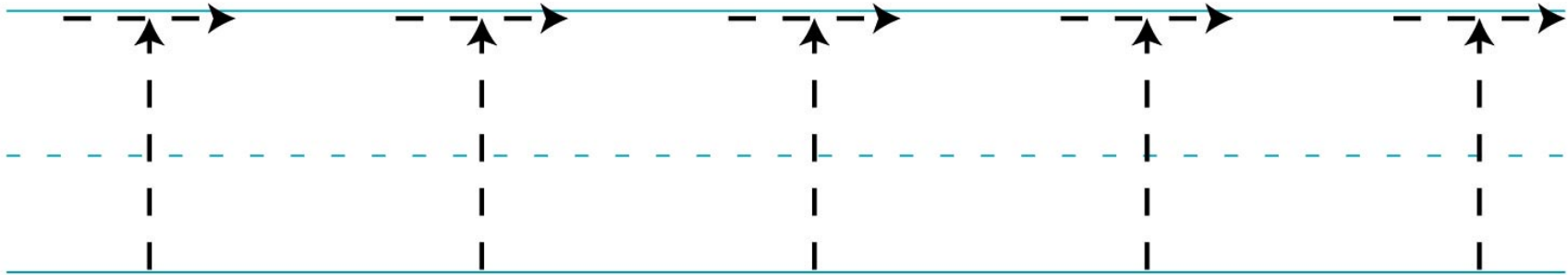
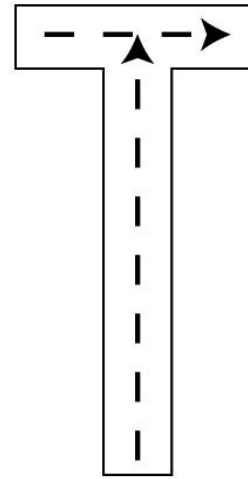
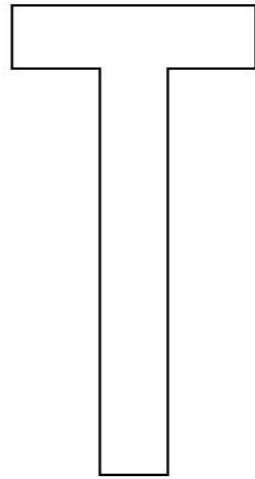

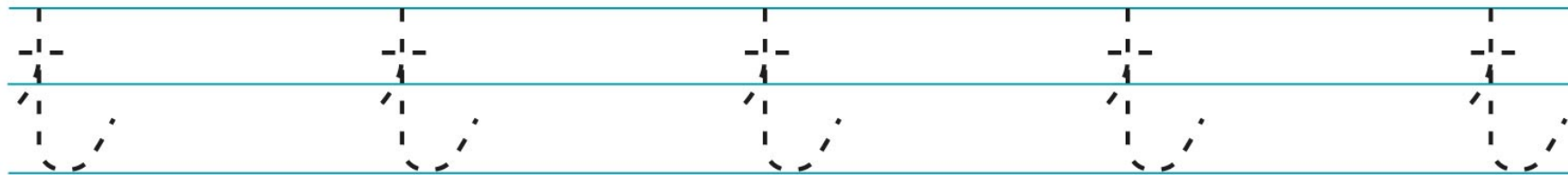
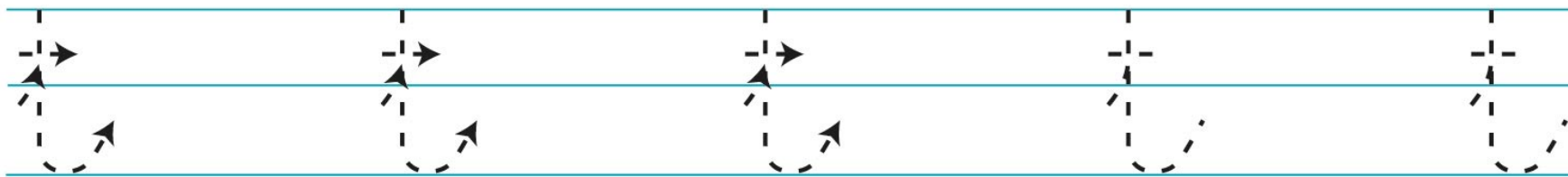
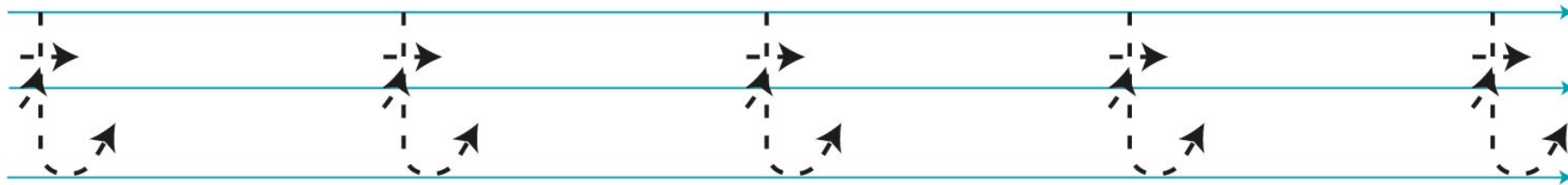
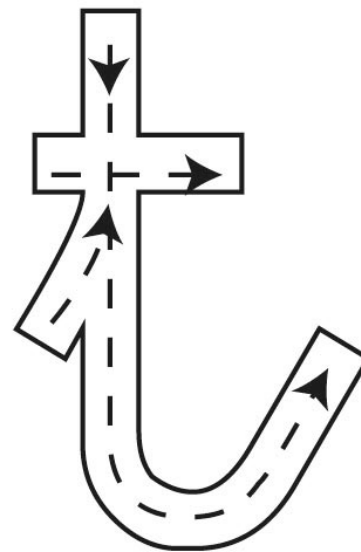
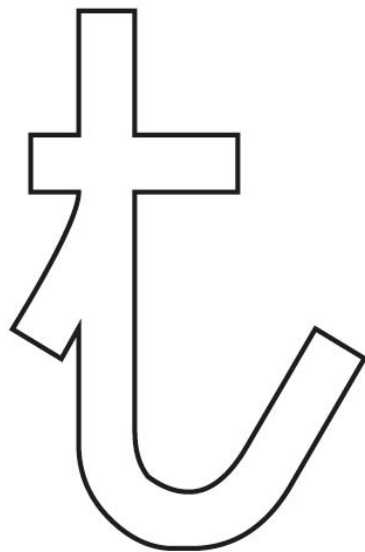

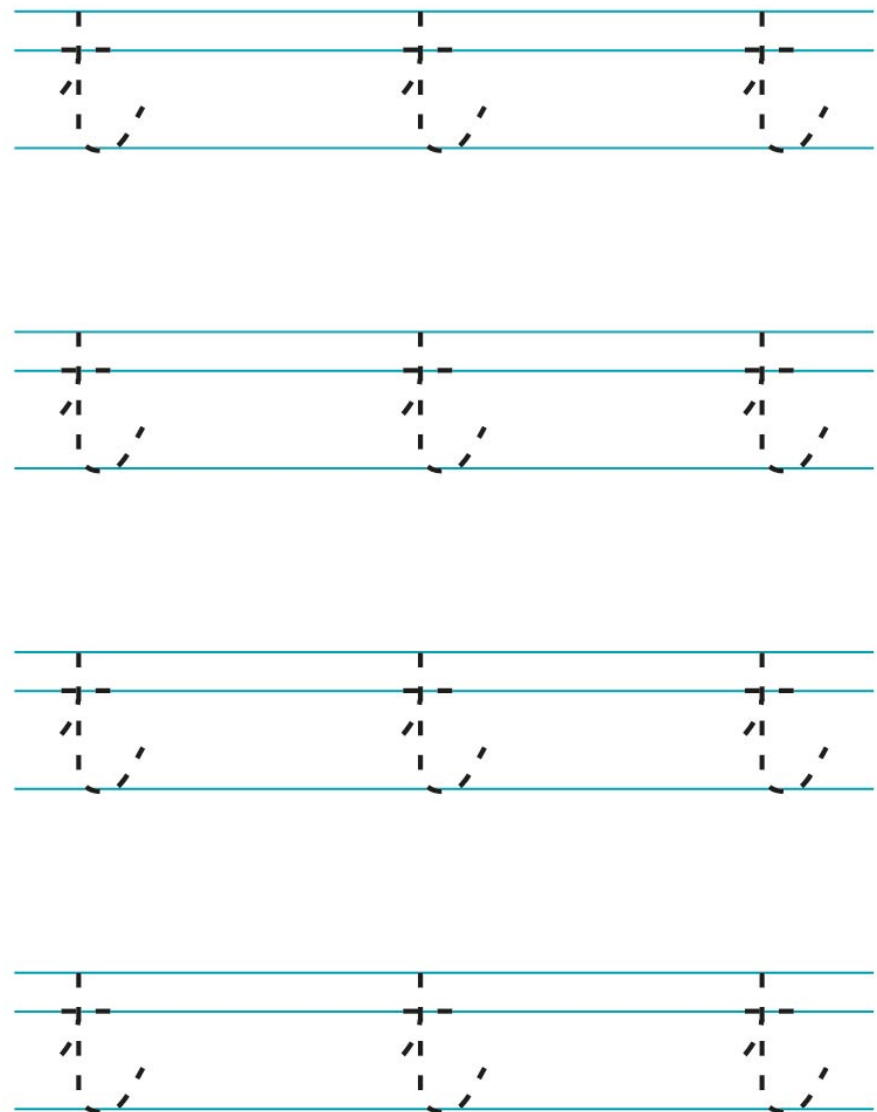
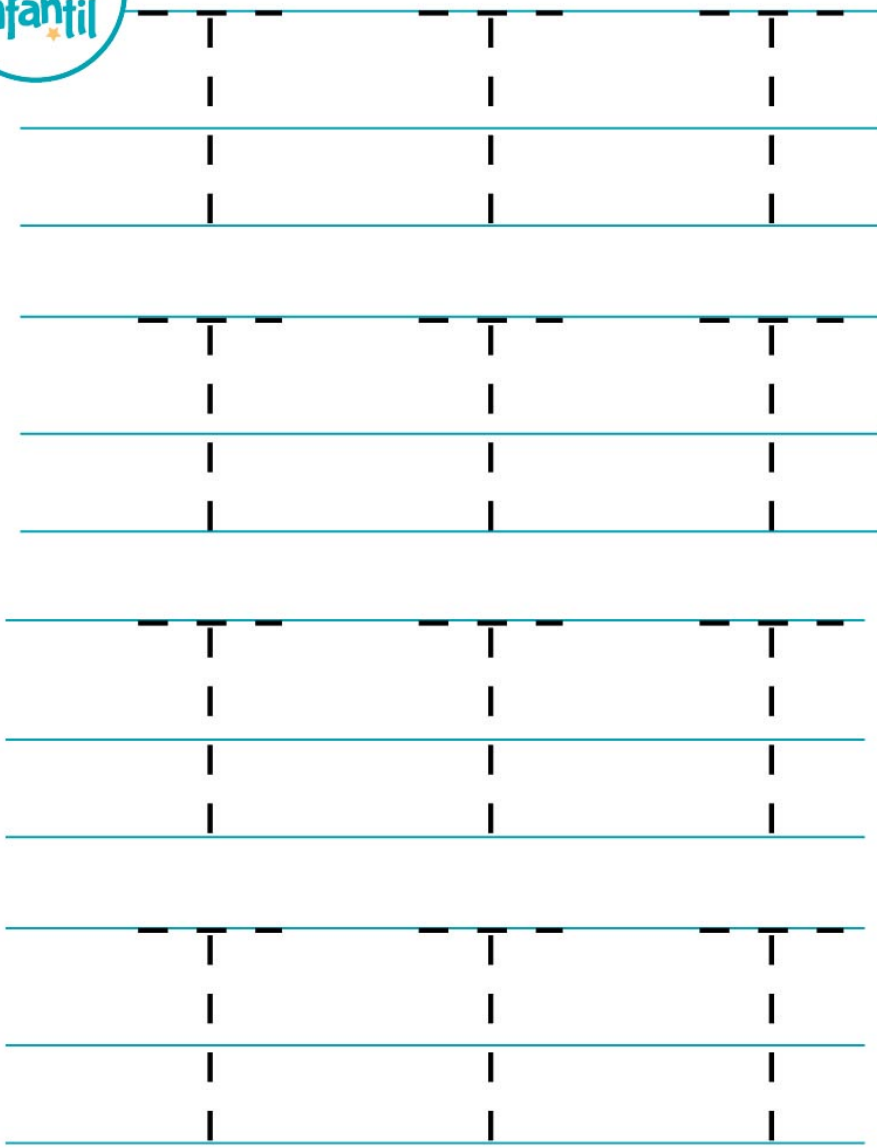

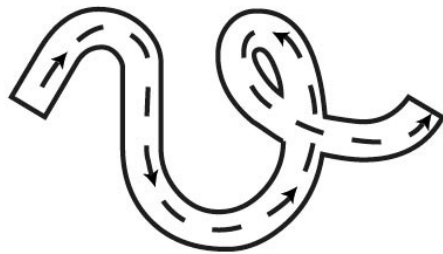
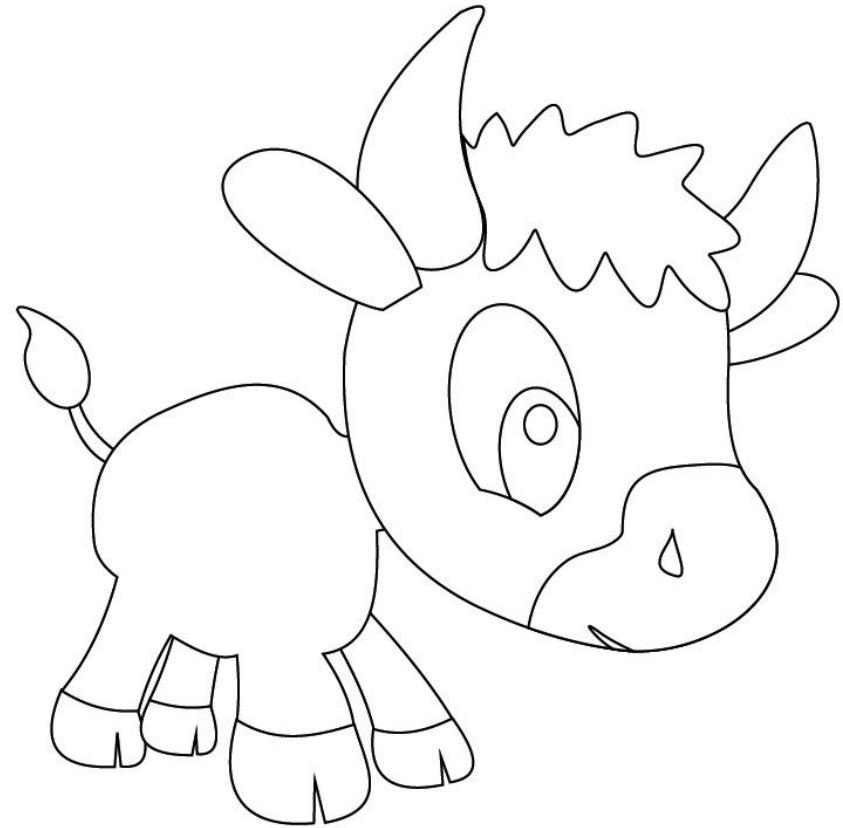
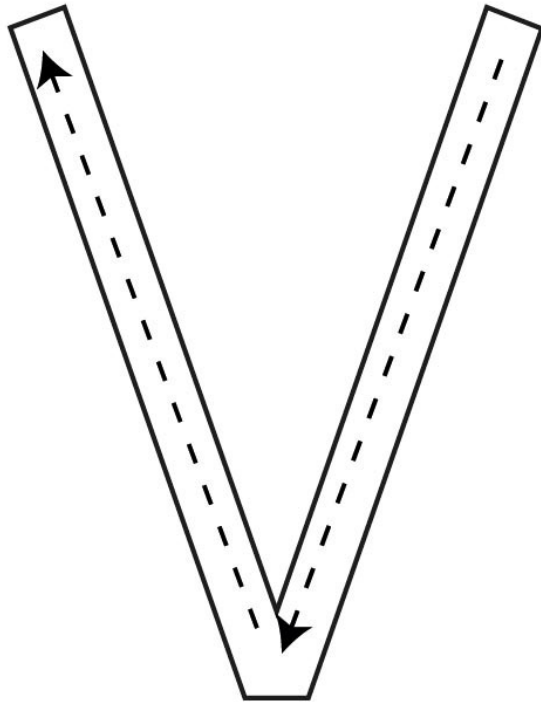

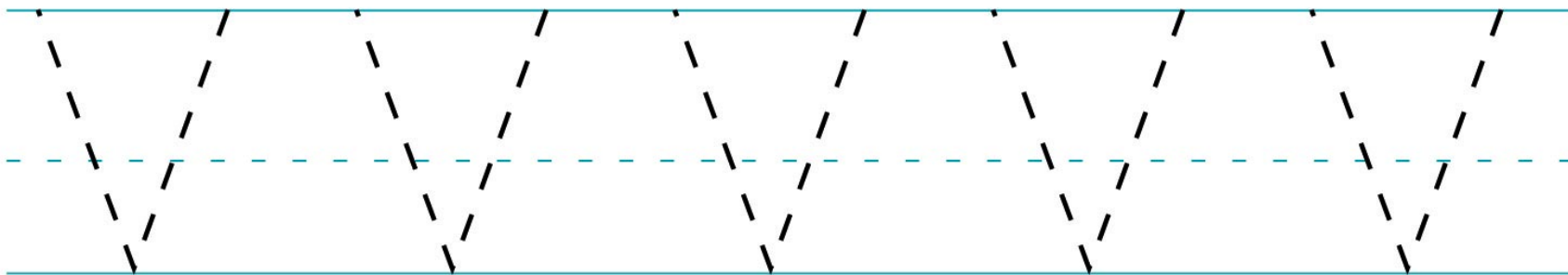
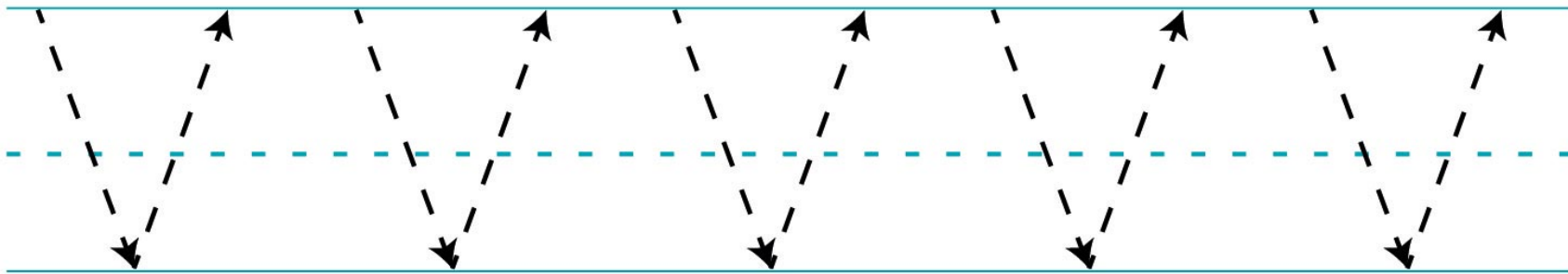
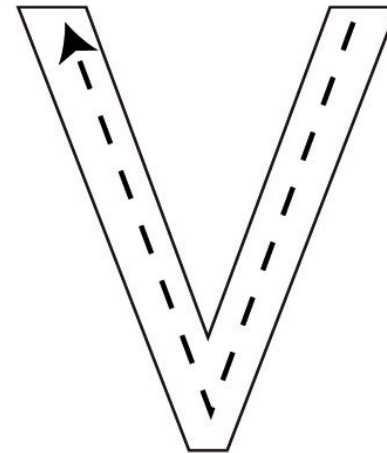
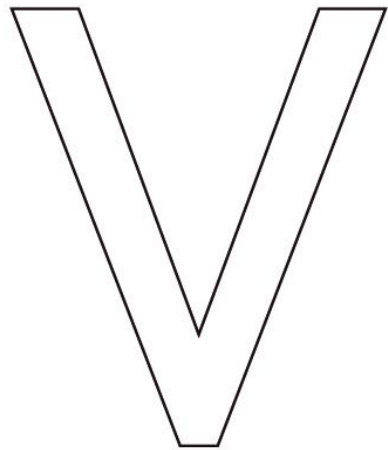

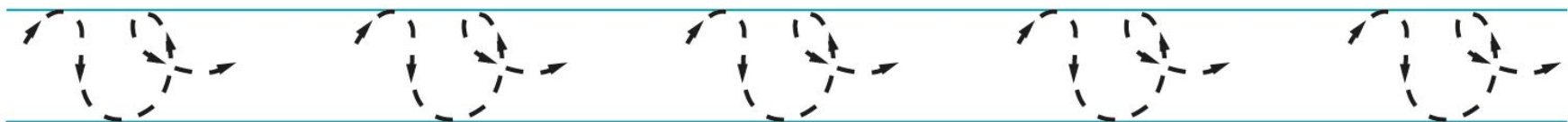
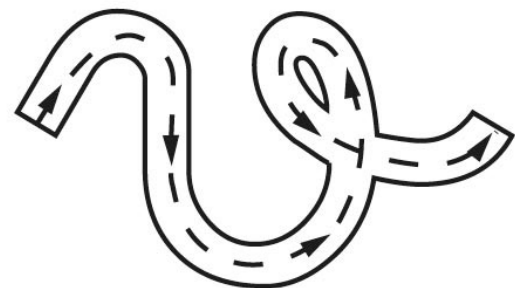
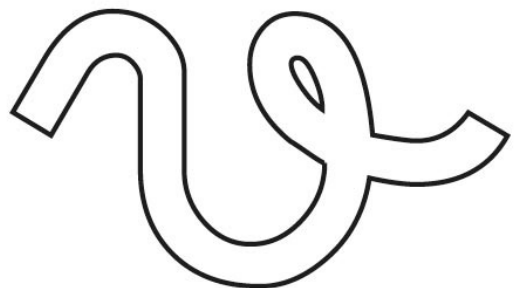

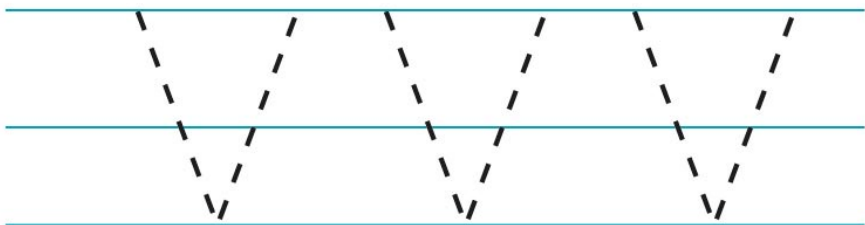
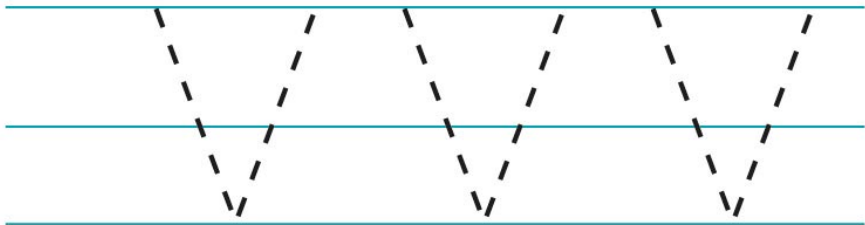
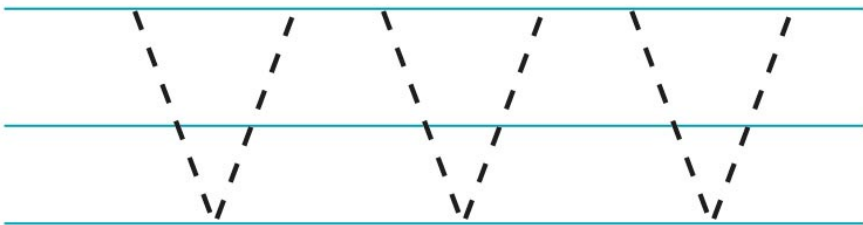
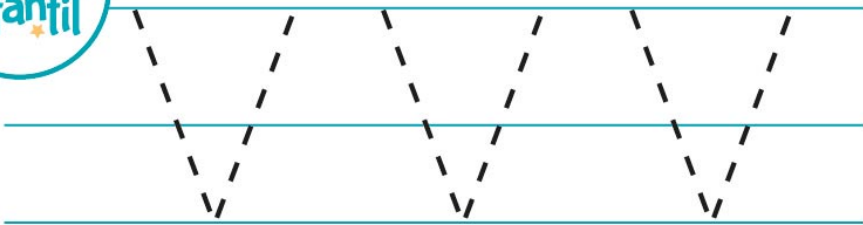

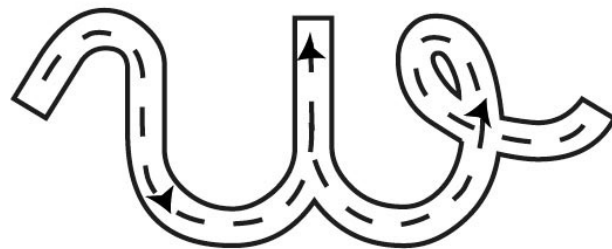
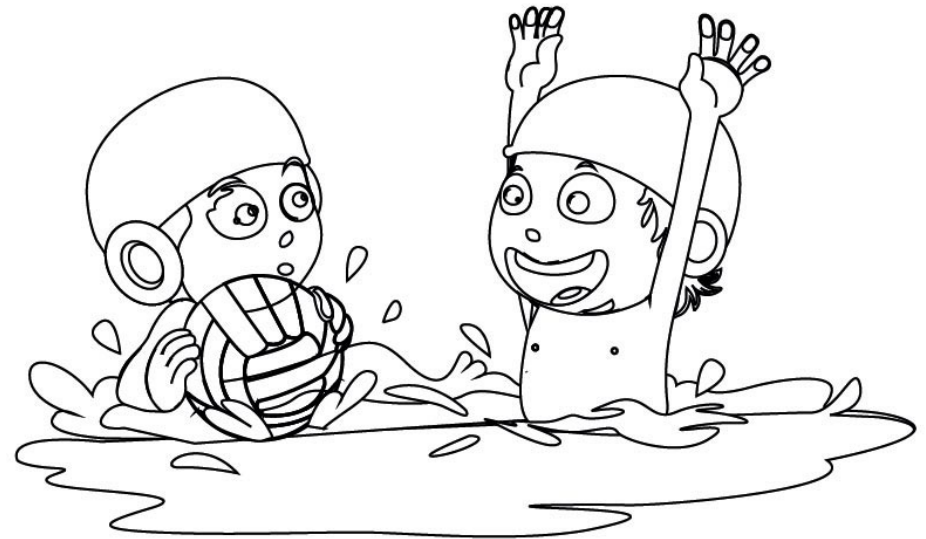
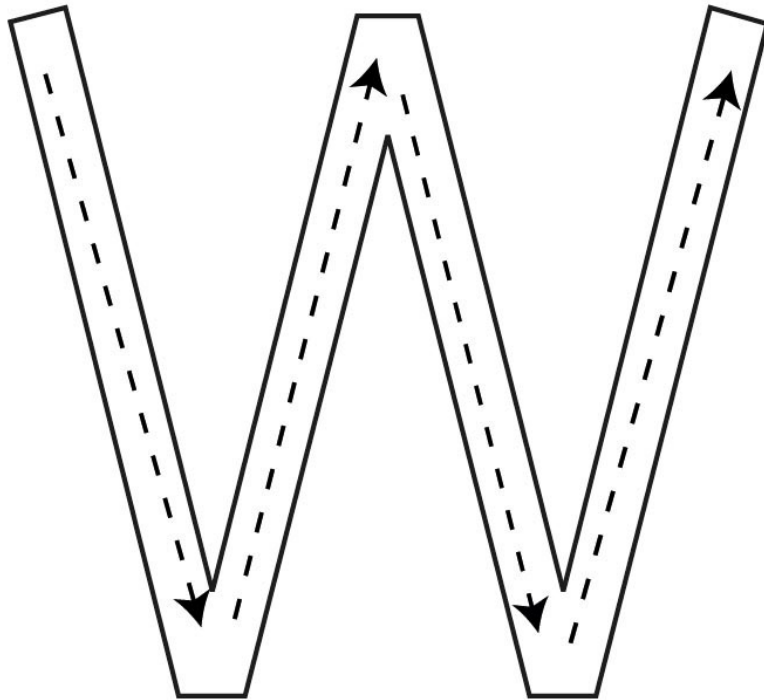

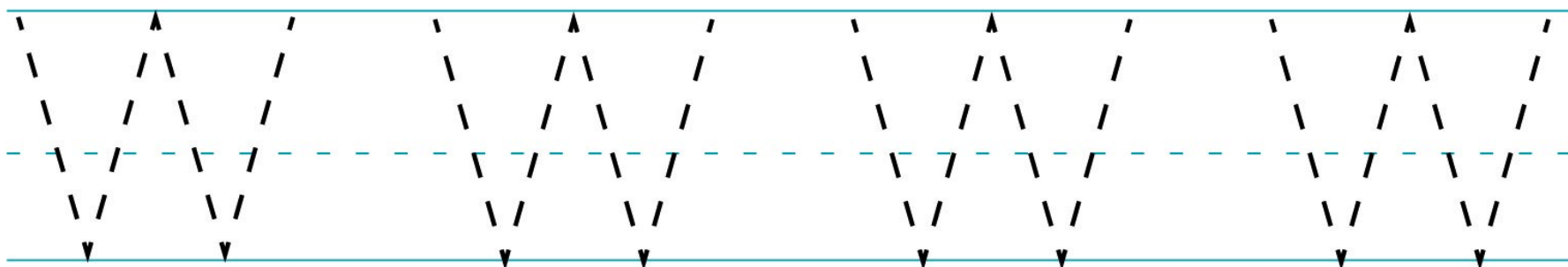
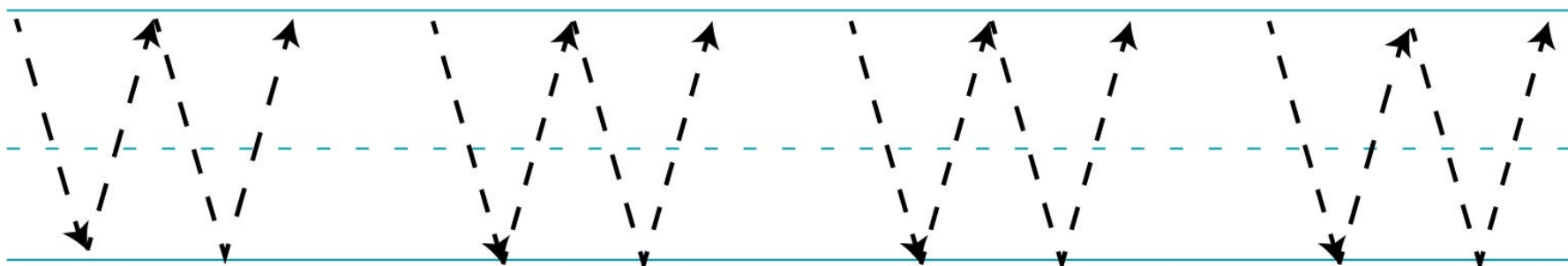
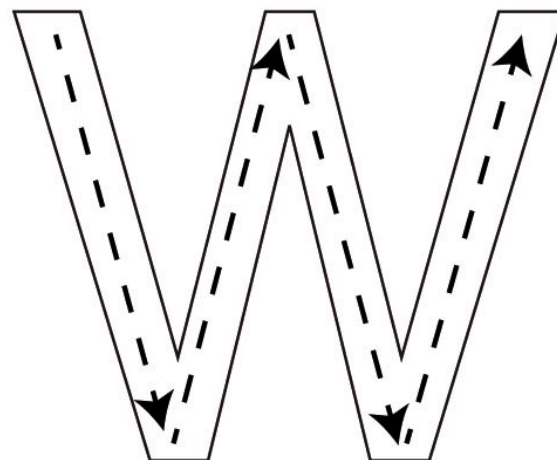
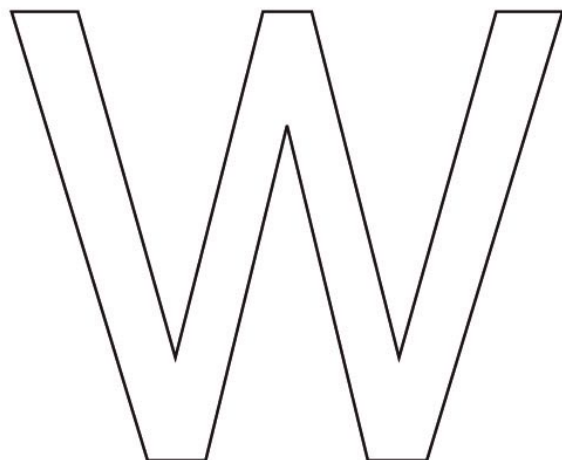

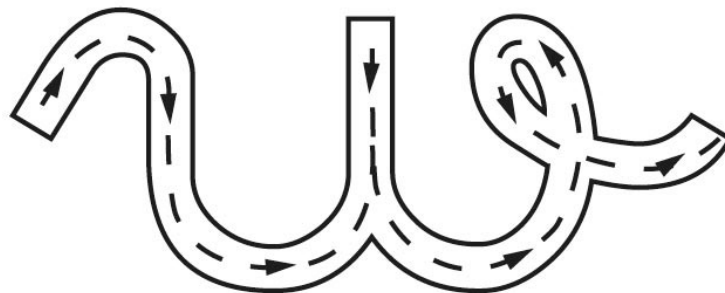

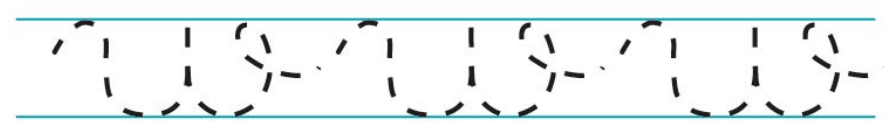
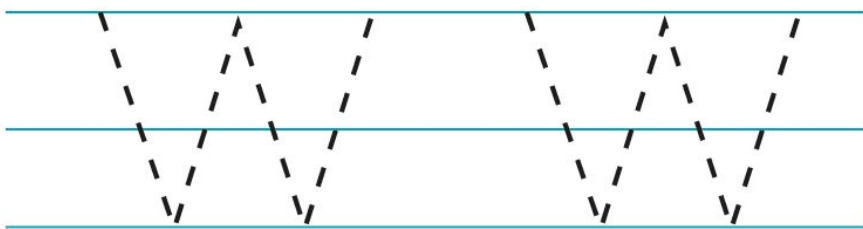
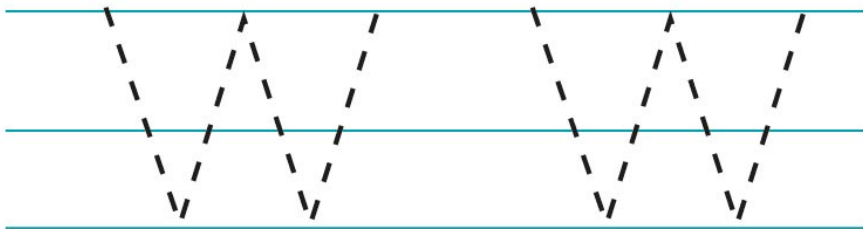
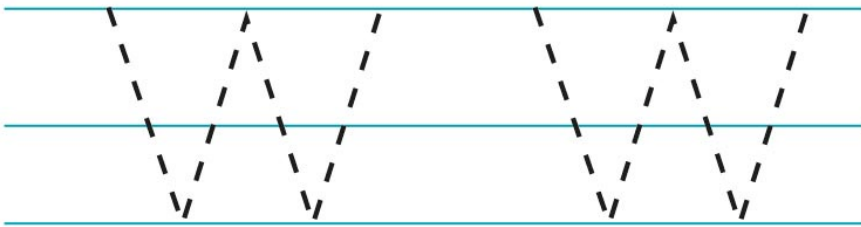
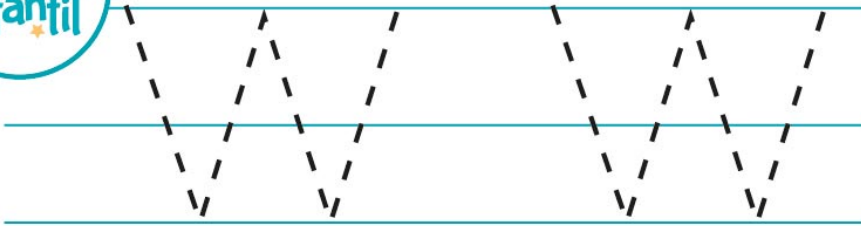

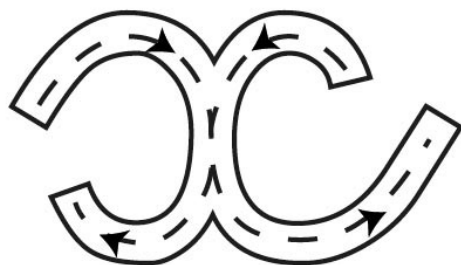
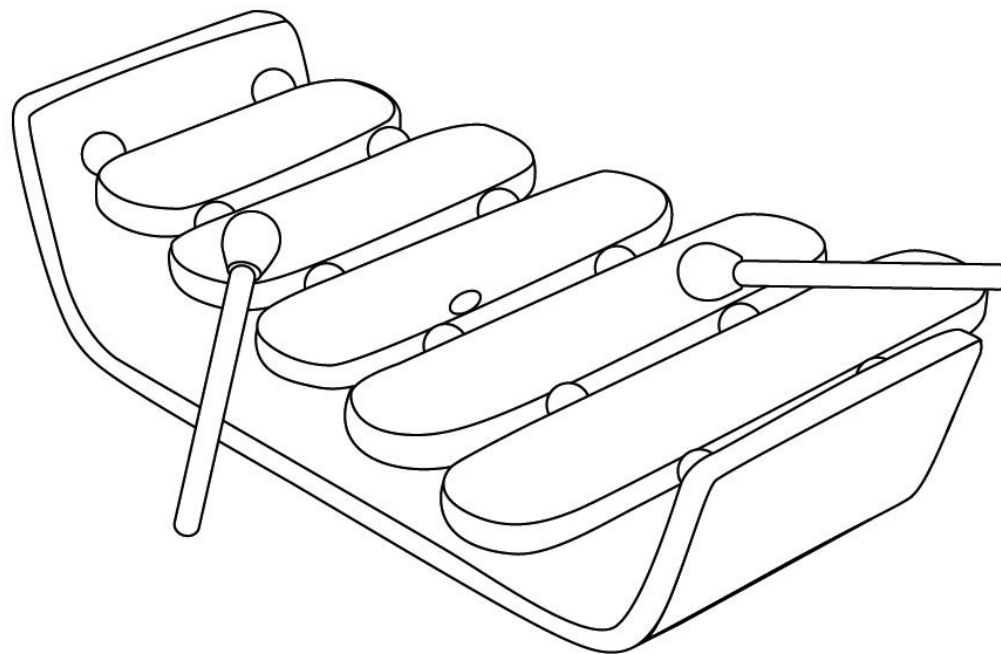
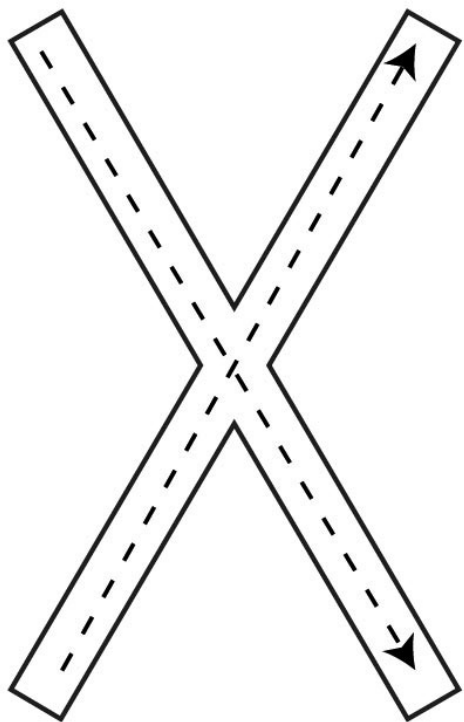

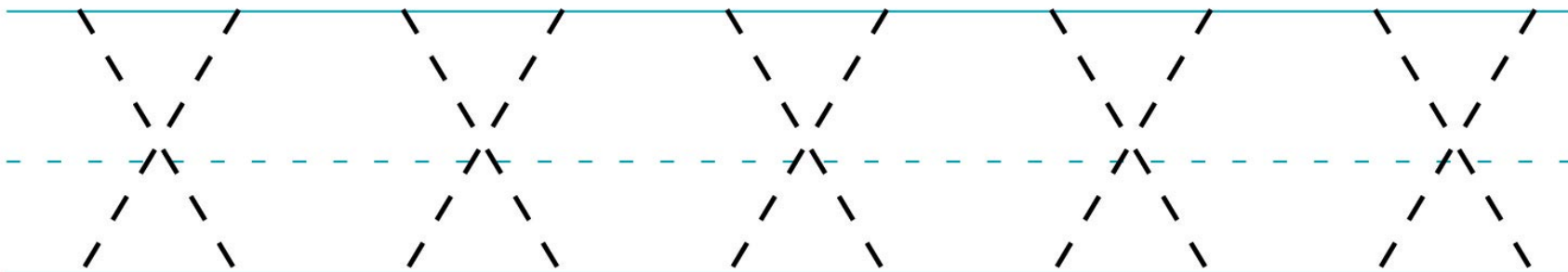
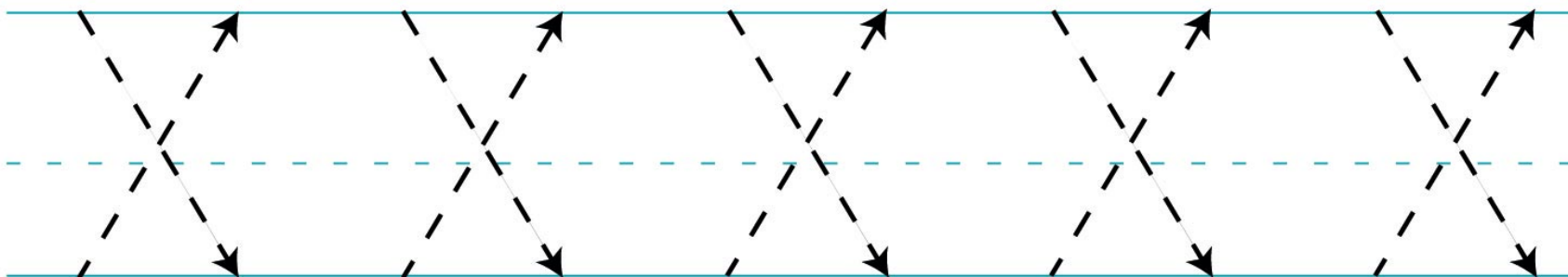
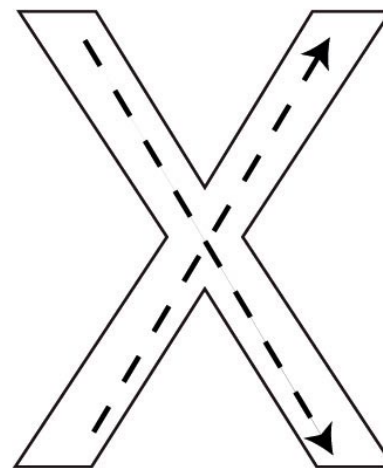
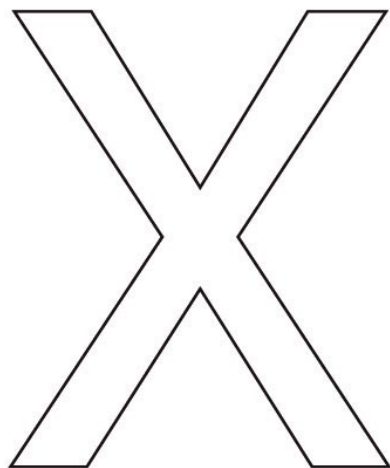

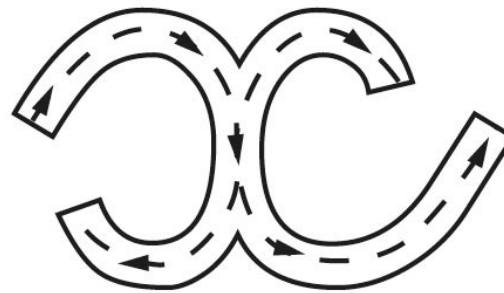
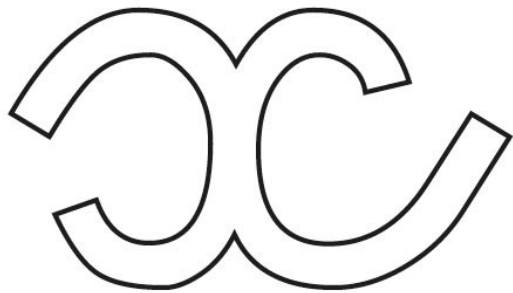

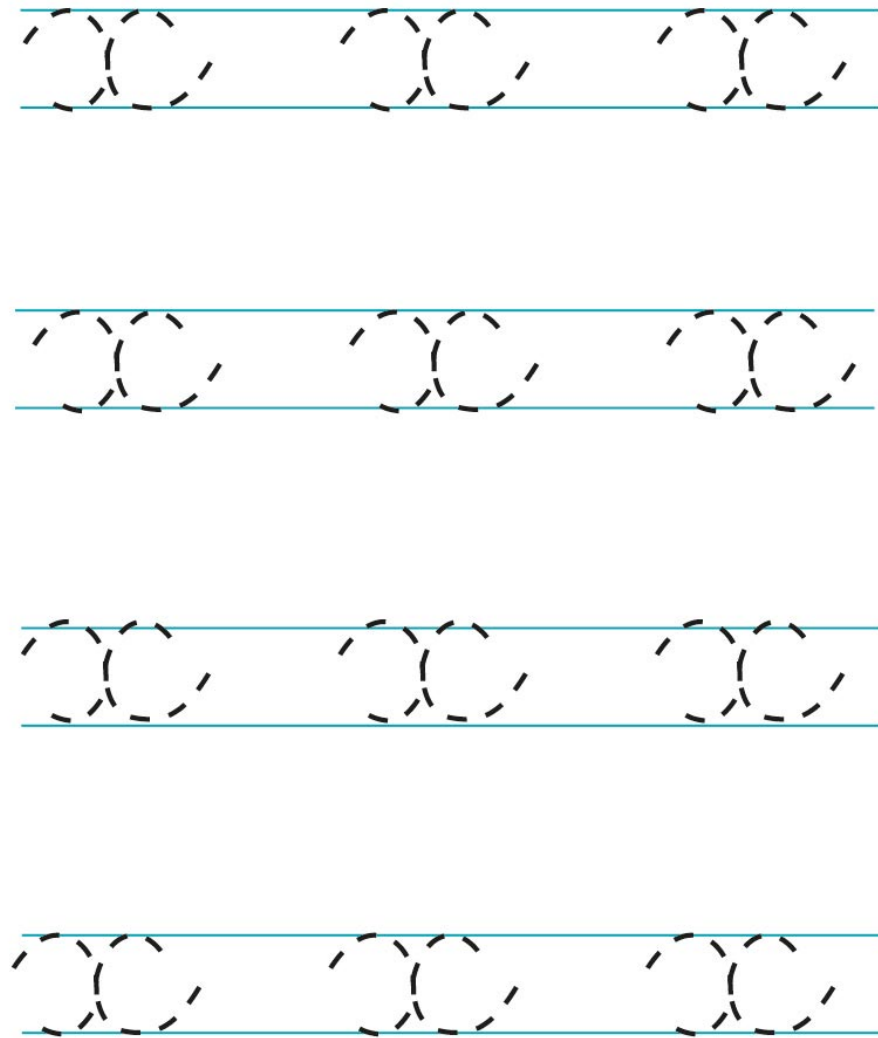
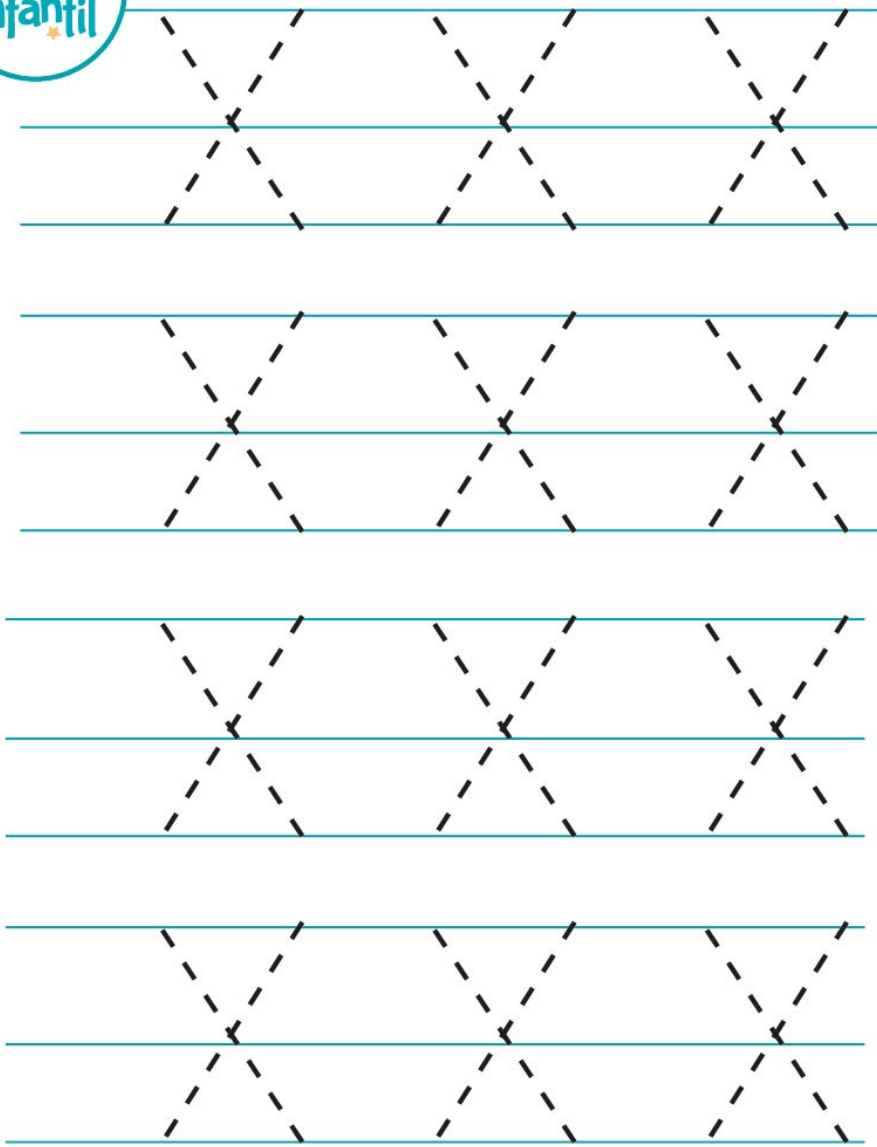

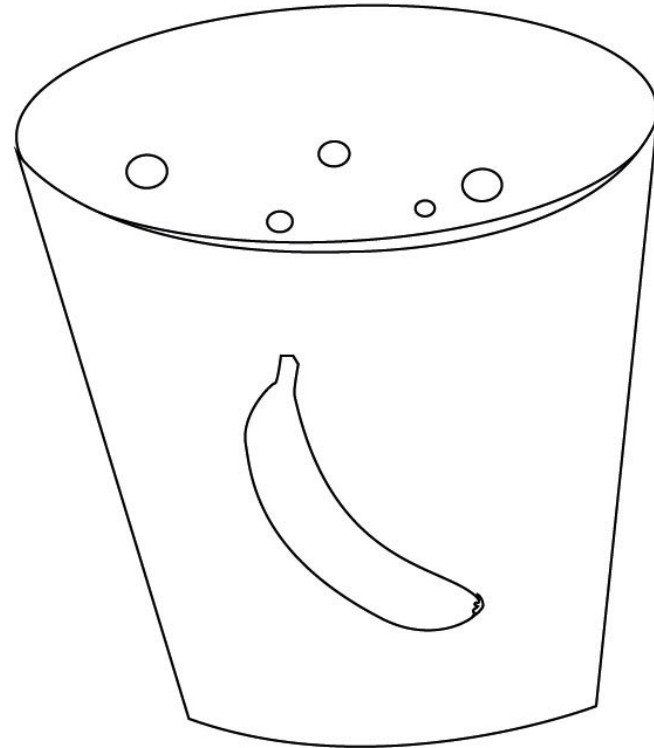
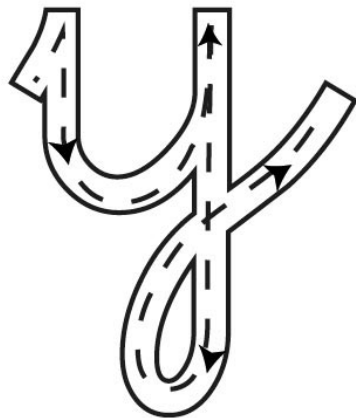
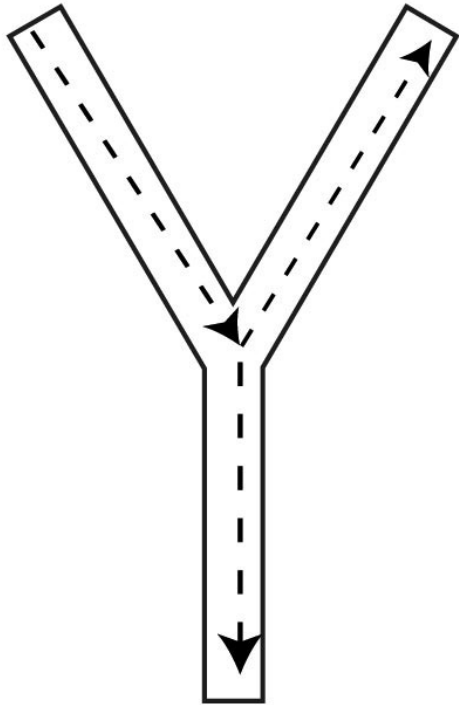

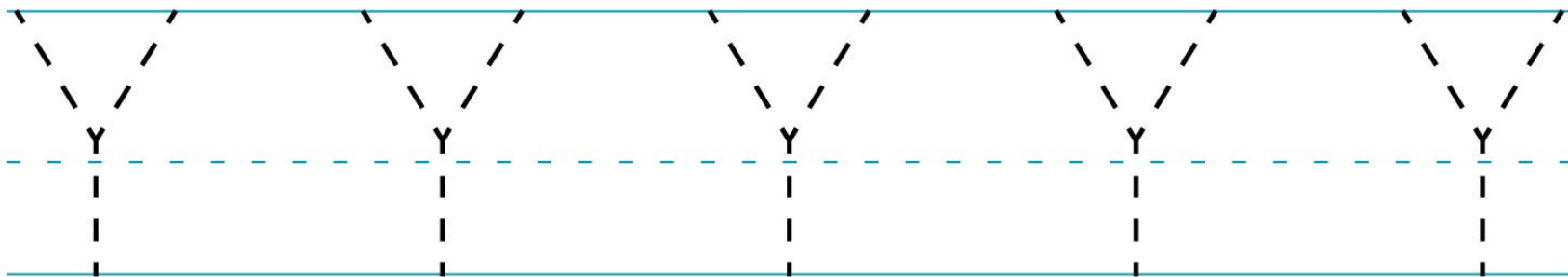
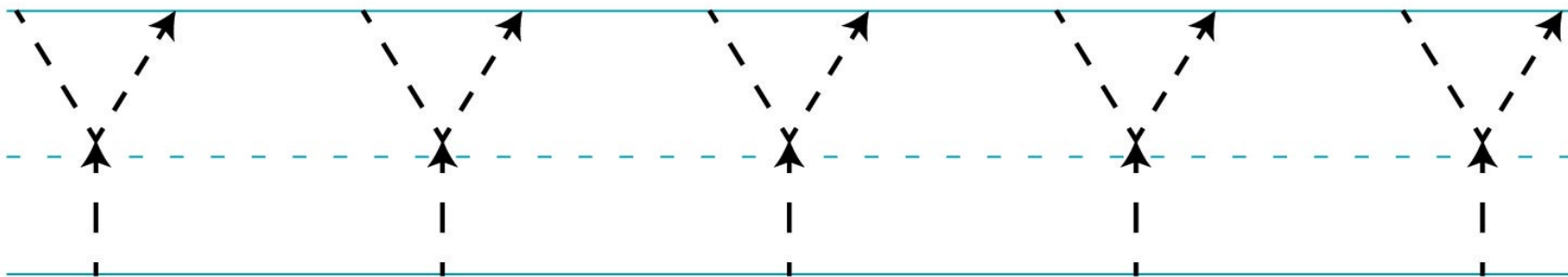
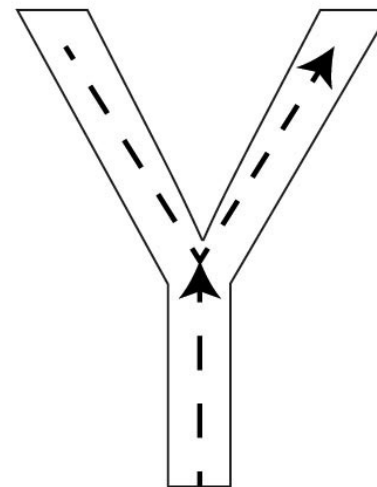
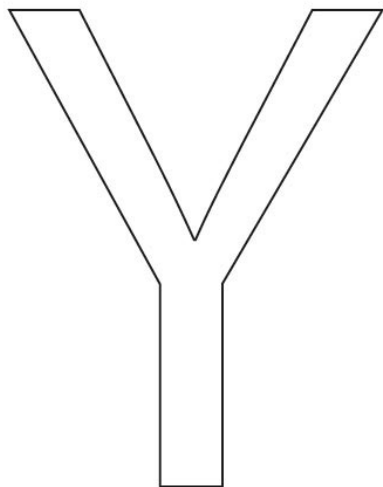

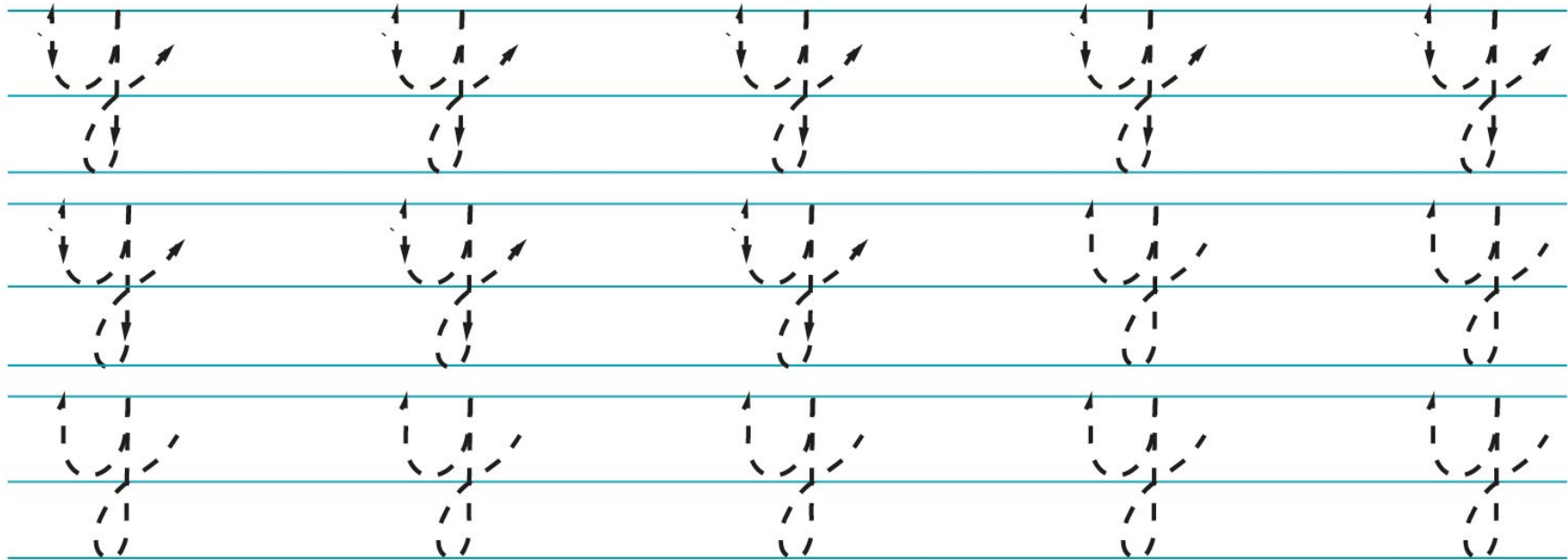
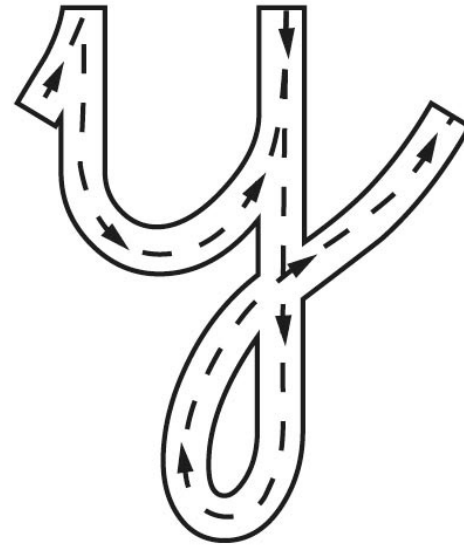
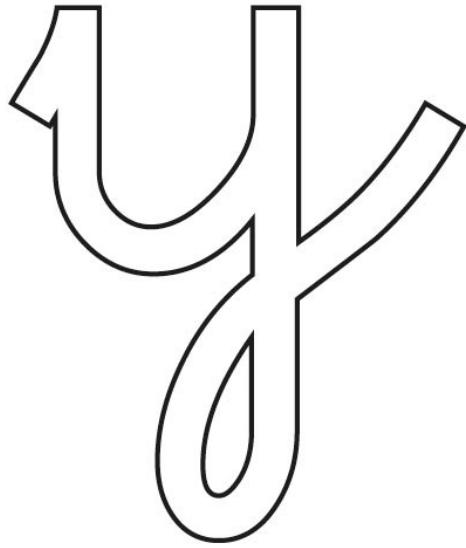

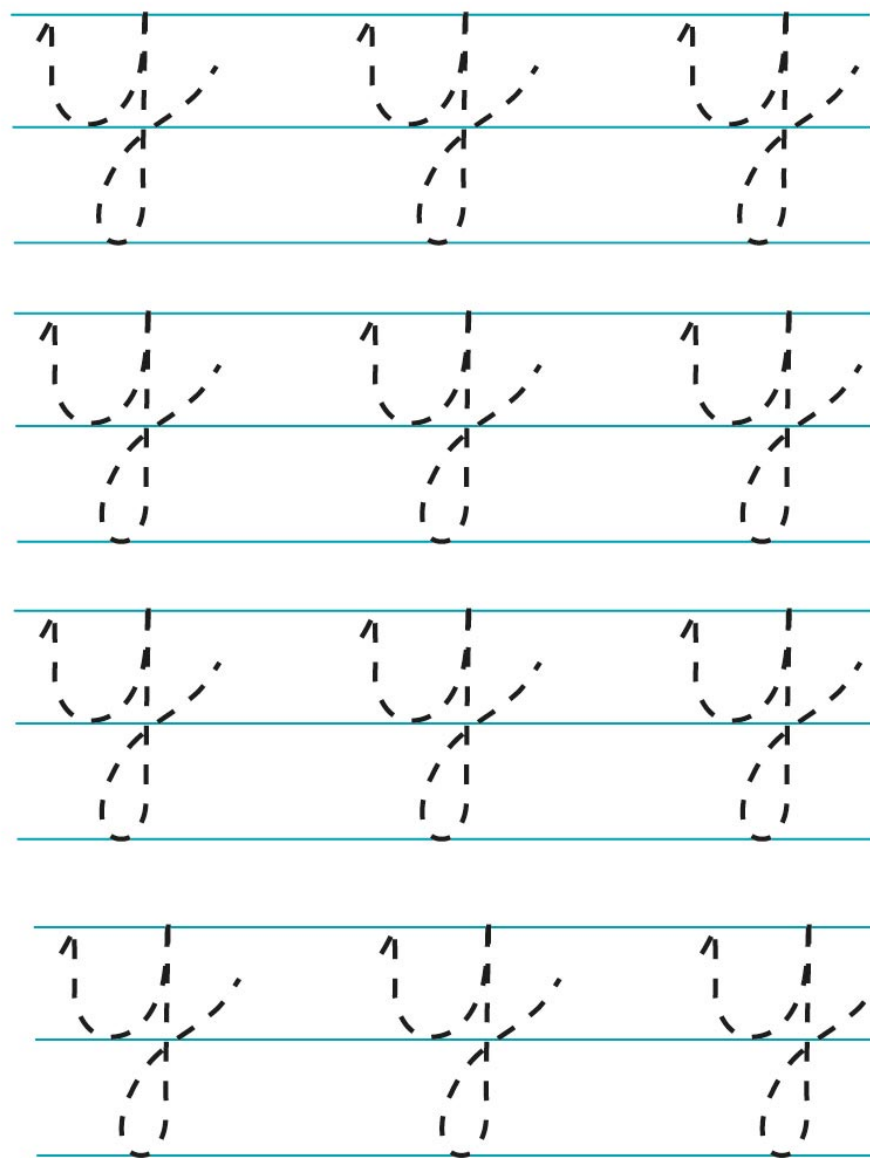
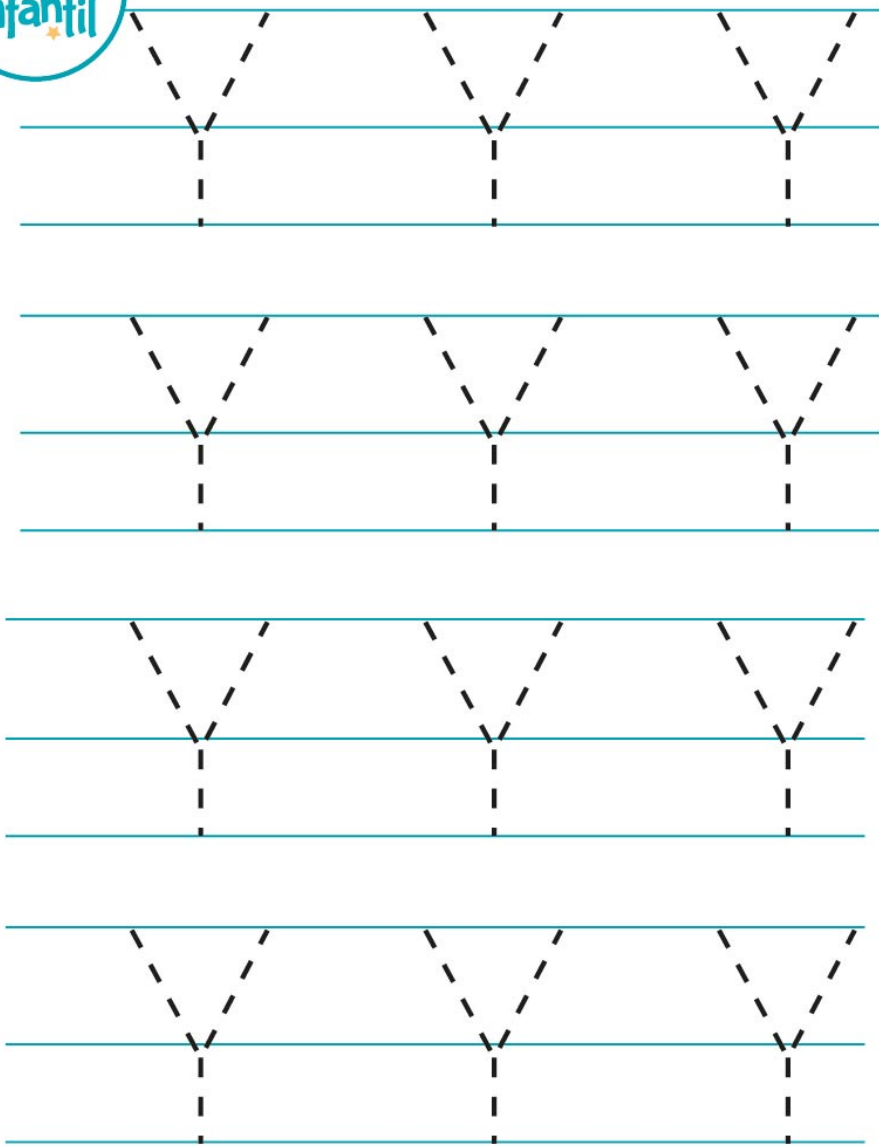

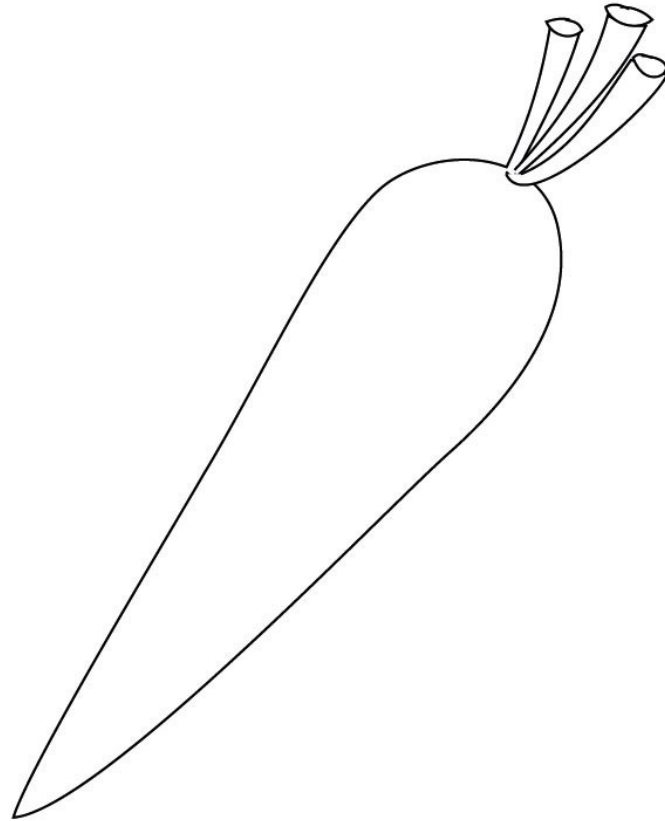
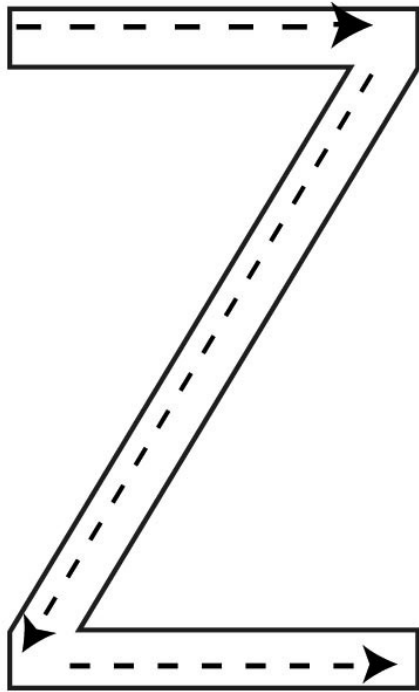

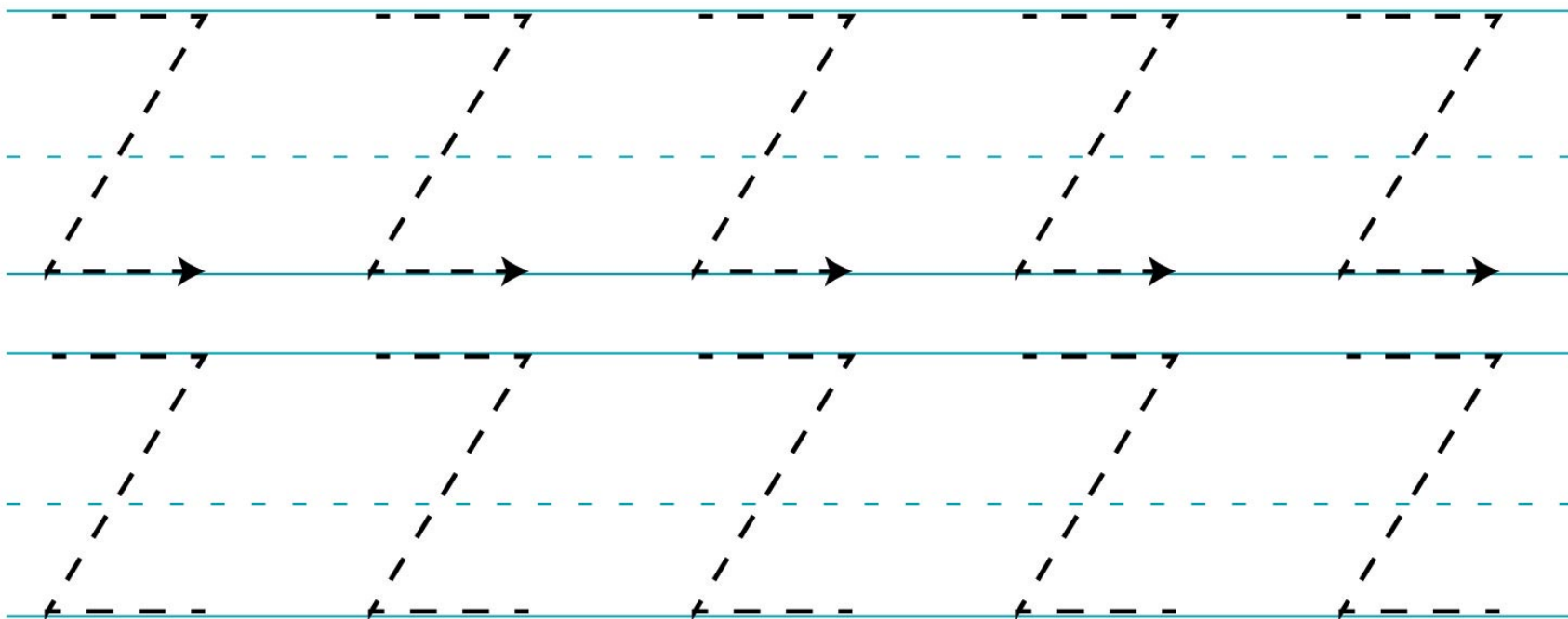
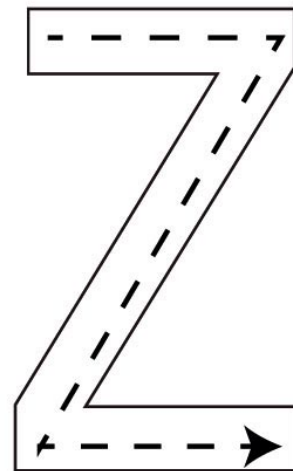
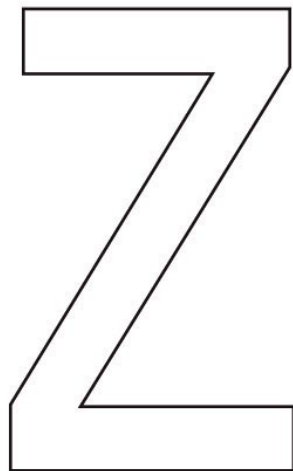

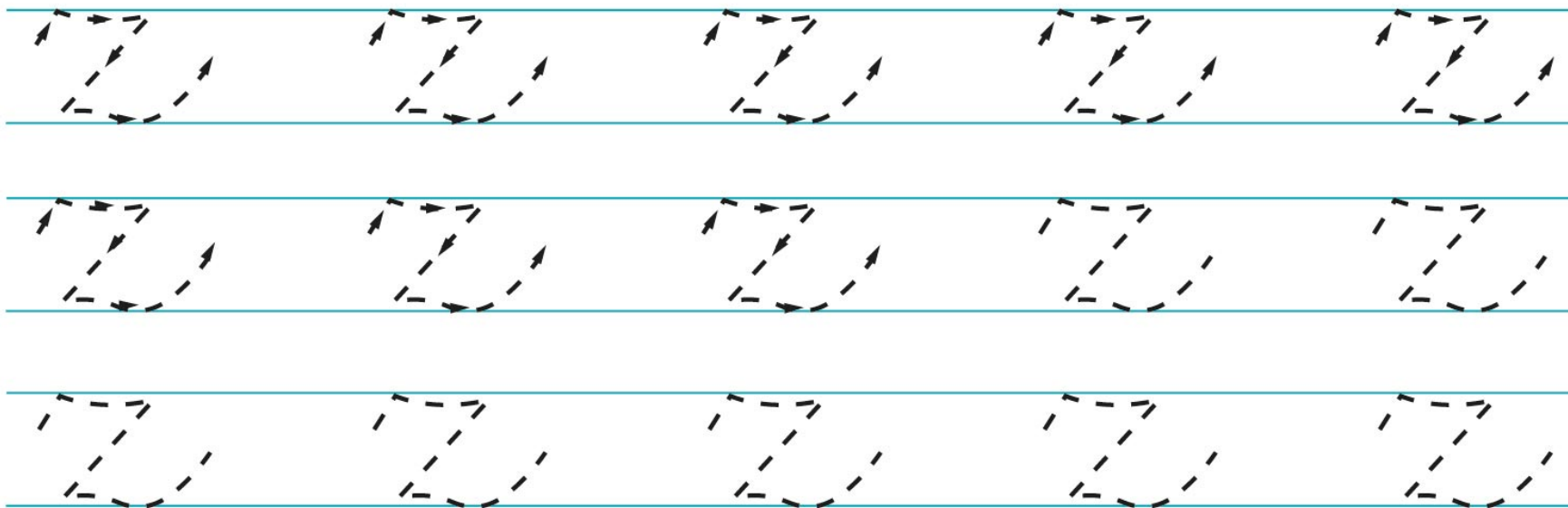
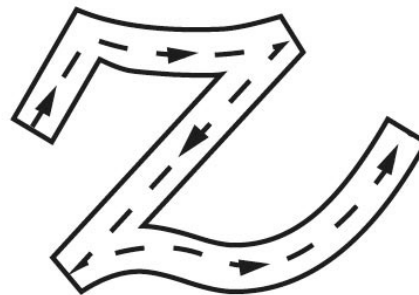

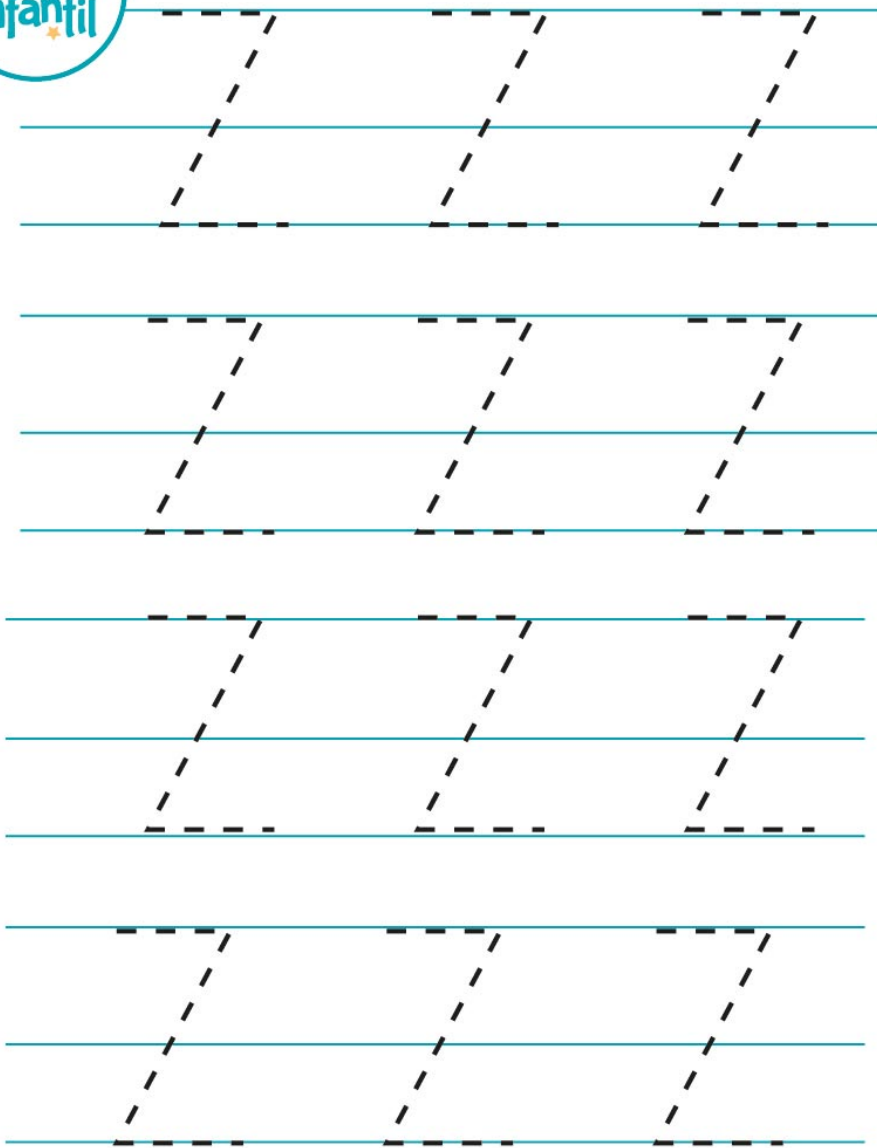

DOSSIER DE ACTIVIDADES

BASADO EN

Ceci y Leo
Los números

DEL



AL

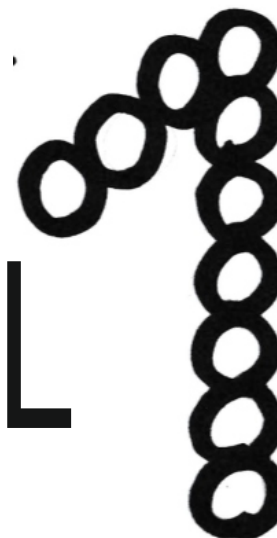

NOMBRE

CURSO

--	--

DÍA

MES

NOMBRE

--	--	--

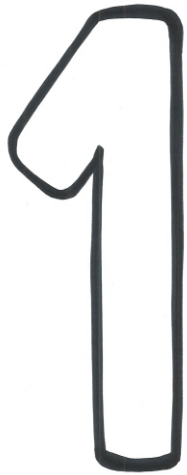

UNO



COLOREA

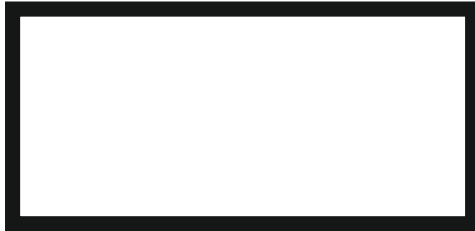

PALILLOS

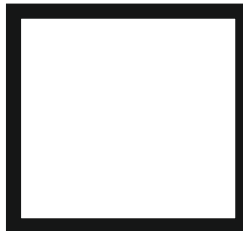

PUNTOS DEL DADO

Ceci y Leo
Los números

PEGATINAS



ESCRIBE EL NÚMERO CON TU LÁPIZ.



DÍA

MES

NOMBRE

--	--	--

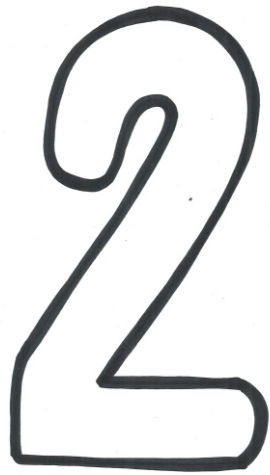

DOS



COLOREA

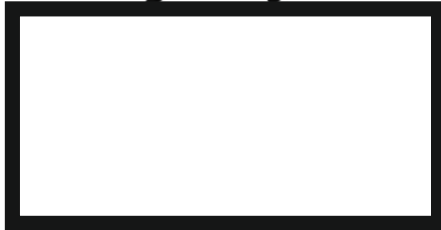

PALILLOS

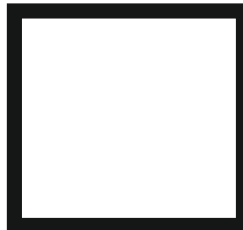

PUNTOS DEL DADO

Ceci y Leo
Los números

PEGATINAS



ESCRIBE EL NÚMERO CON TU LÁPIZ.



DÍA

MES

NOMBRE

--	--	--

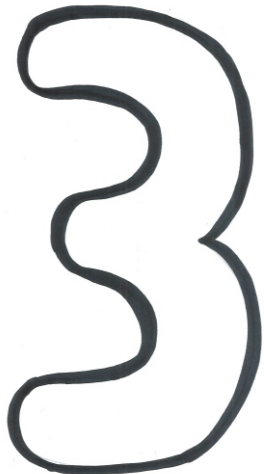

TRES



COLOREA

--

PALILLOS

--

PUNTOS DEL DADO

Ceci y Leo
Los números

PEGATINAS



ESCRIBE EL NÚMERO CON TU LÁPIZ.



DÍA

MES

NOMBRE

--	--	--

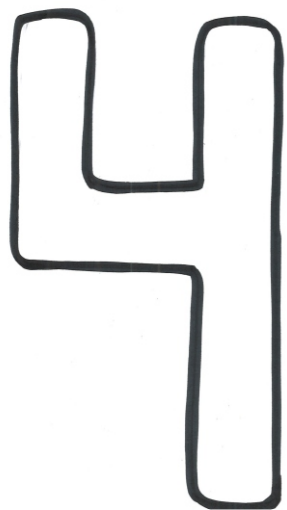

COLOREA

Ceci y Leo
Los números

CUATRO

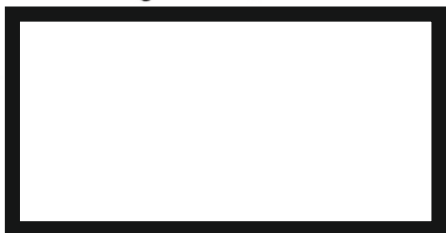

PALILLOS

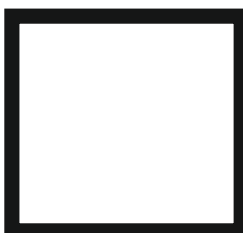

PUNTOS DEL DADO

PEGATINAS



ESCRIBE EL NÚMERO CON TU LÁPIZ.



DÍA

MES

NOMBRE

--	--	--

5



COLOREA

Ceci y Leo
Los números

CINCO

--

PALILLOS

--

PUNTOS DEL DADO

PEGATINAS



ESCRIBE EL NÚMERO CON TU LÁPIZ.



DÍA

MES

NOMBRE

--	--	--



COLOREA



Ceci y Leo
Los números

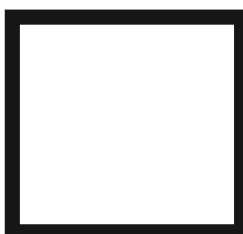
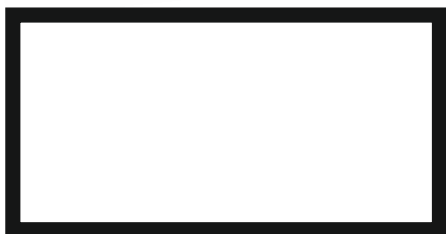

SEIS

PALILLOS

PUNTOS DEL DADO

PEGATINAS



ESCRIBE EL NÚMERO CON TU LÁPIZ.



DÍA

MES

NOMBRE

--	--	--

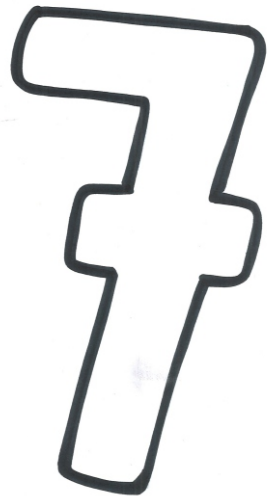

COLOREA



Ceci y Leo
Los números

SIETE

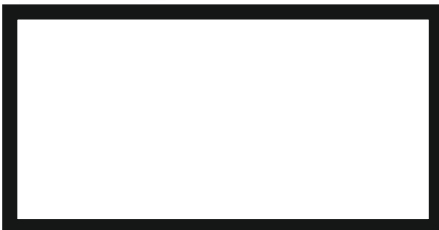

PALILLOS

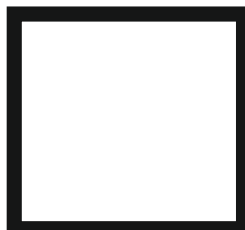

PUNTOS DEL DADO

PEGATINAS

--

ESCRIBE EL NÚMERO CON TU LÁPIZ.



DÍA

MES

NOMBRE

--	--	--

COLOREA

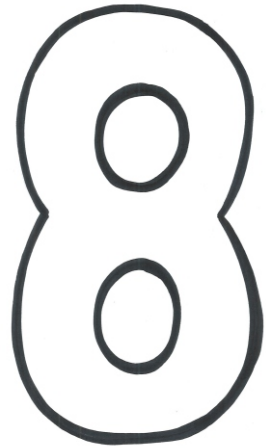

Ceci y Leo

Los números

--

PALILLOS

--

PUNTOS DEL DADO

PEGATINAS

OCHO

--	--

ESCRIBE EL NÚMERO CON TU LÁPIZ.



DÍA

MES

NOMBRE

--	--	--

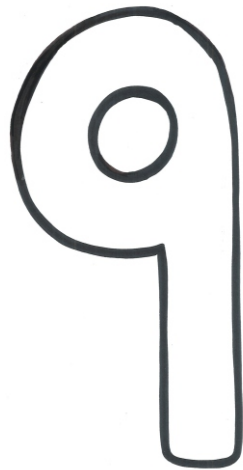

COLOREA



Ceci y Leo
Los números

NUEVE



PALILLOS

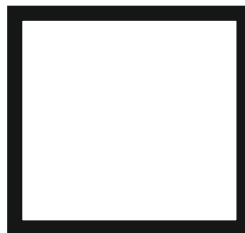

PUNTOS DEL DADO

PEGATINAS



ESCRIBE EL NÚMERO CON TU LÁPIZ.

DÍA

MES

NOMBRE

--	--	--

COLOREA

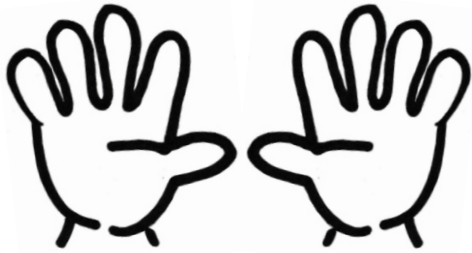
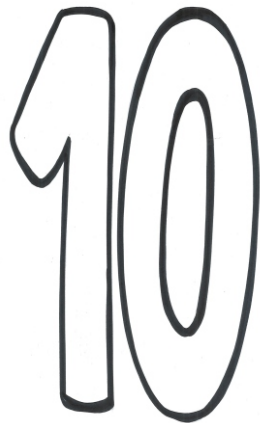

Ceci y Leo
Los números

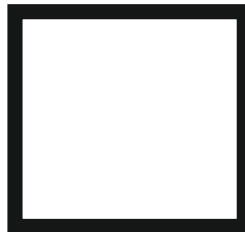

DIEZ

PALILLOS

PUNTOS DEL DADO

PEGATINAS

ESCRIBE EL NÚMERO CON TU LÁPIZ.



BUSCA LAS 5 DIFERENCIAS Y COLOREA



Busca las 5 diferencias y colorea

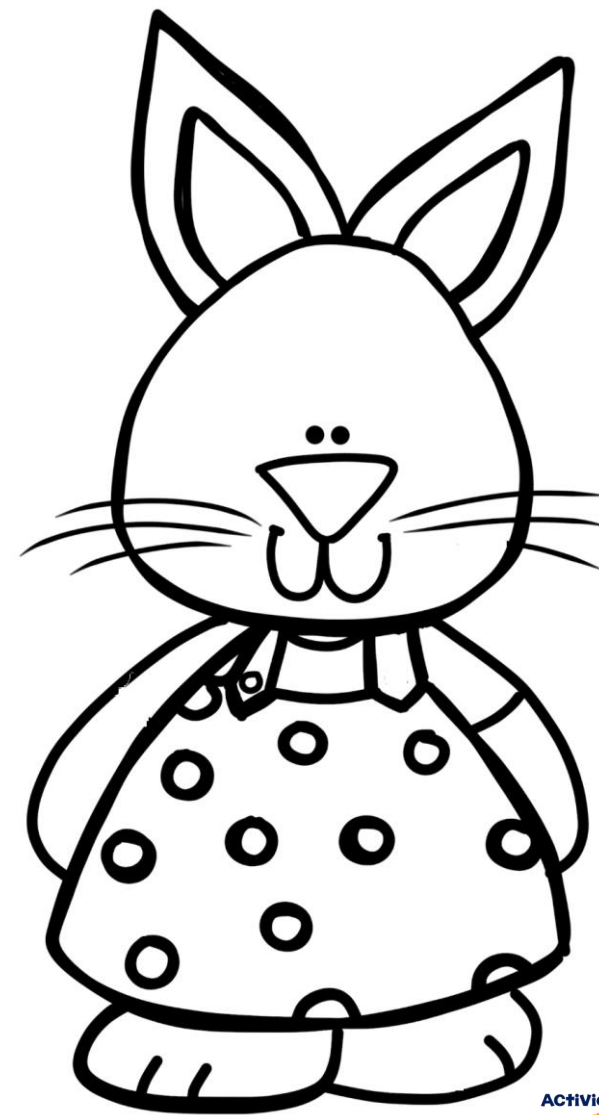
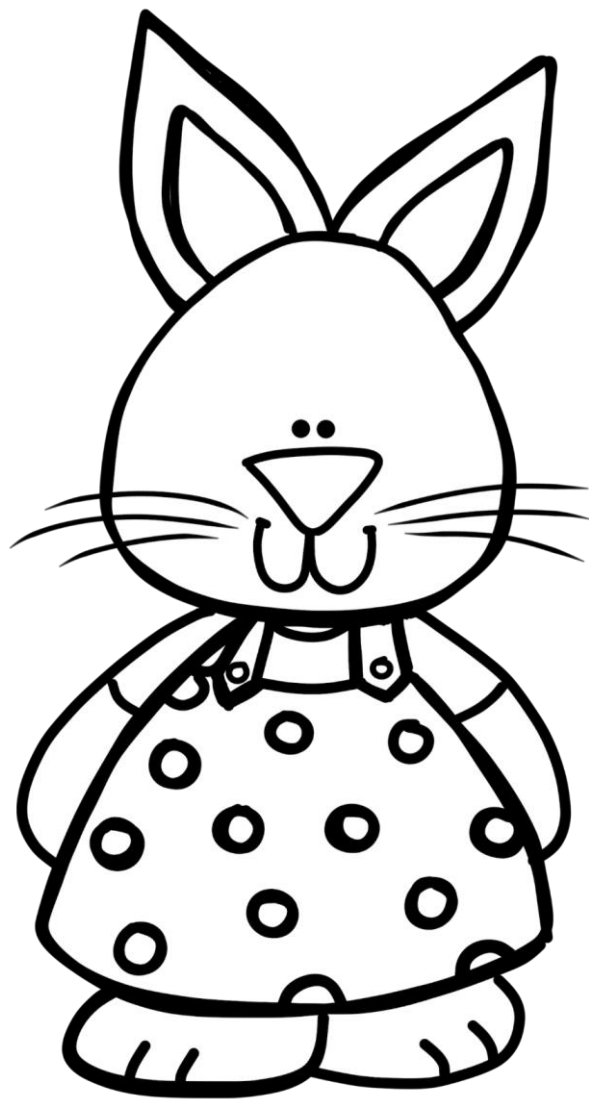

Busca las 5 diferencias y colorea

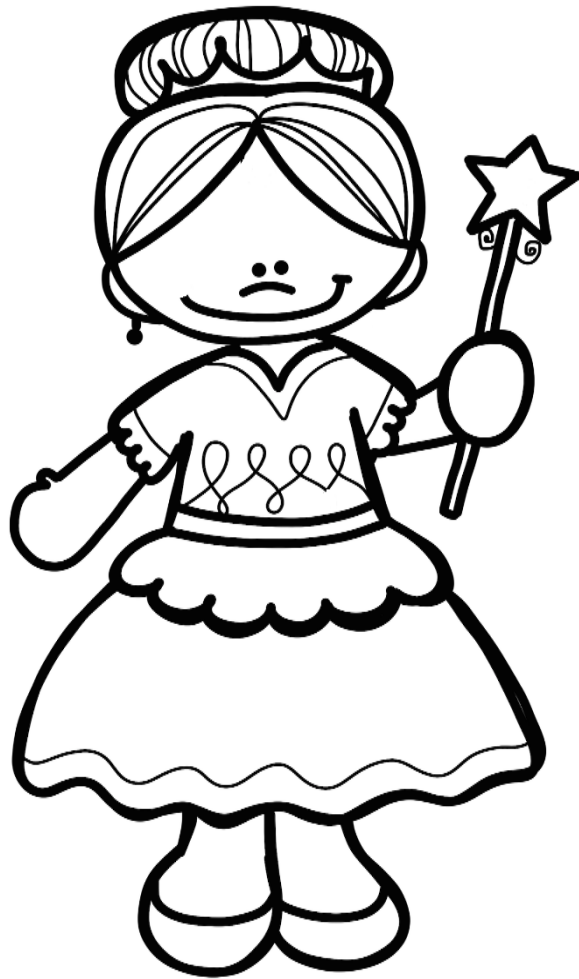

Busca las 5 diferencias y colorea

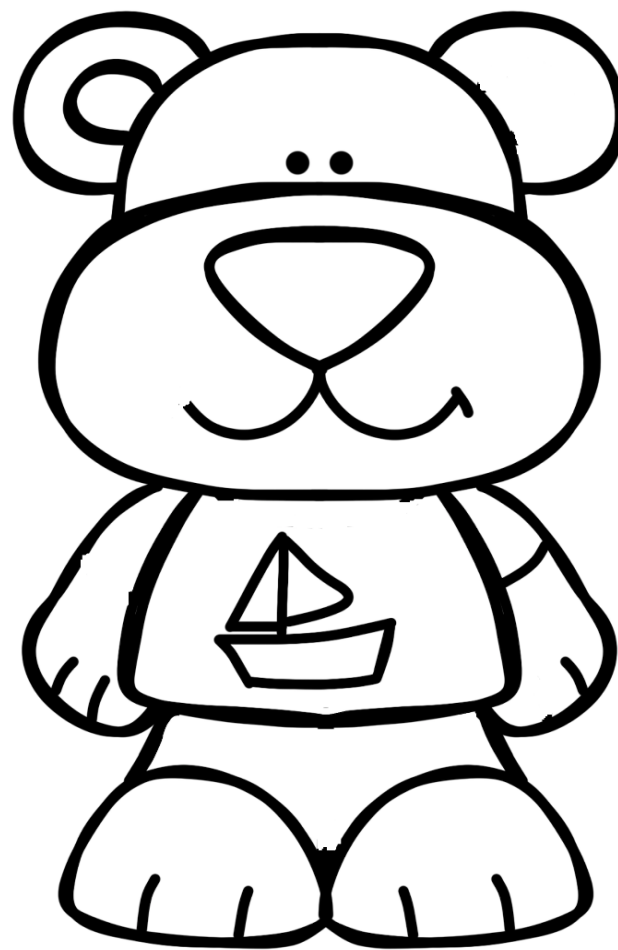
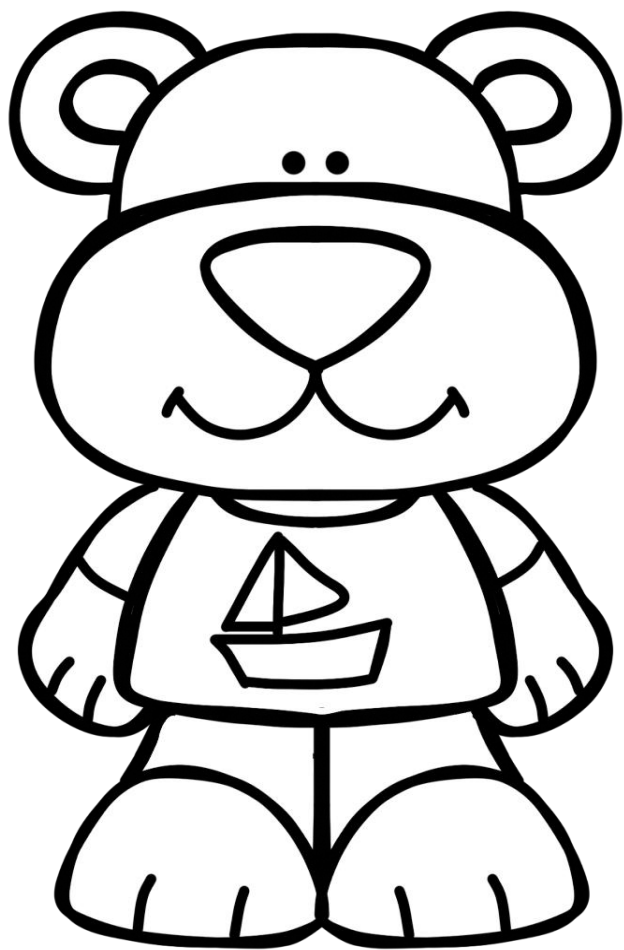

Busca las 5 diferencias y colorea

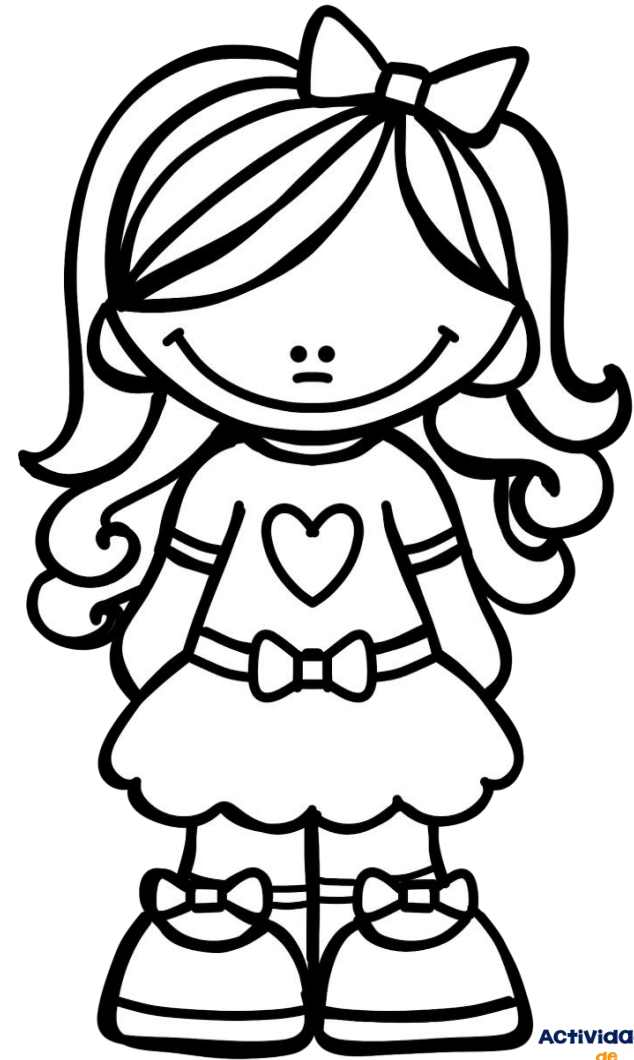
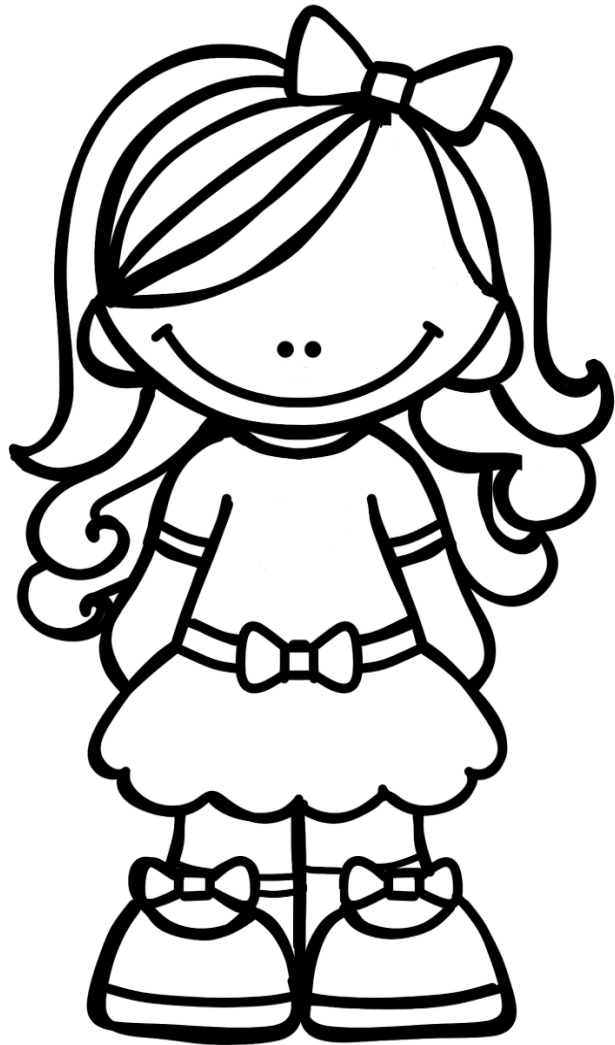

Busca las 5 diferencias y colorea

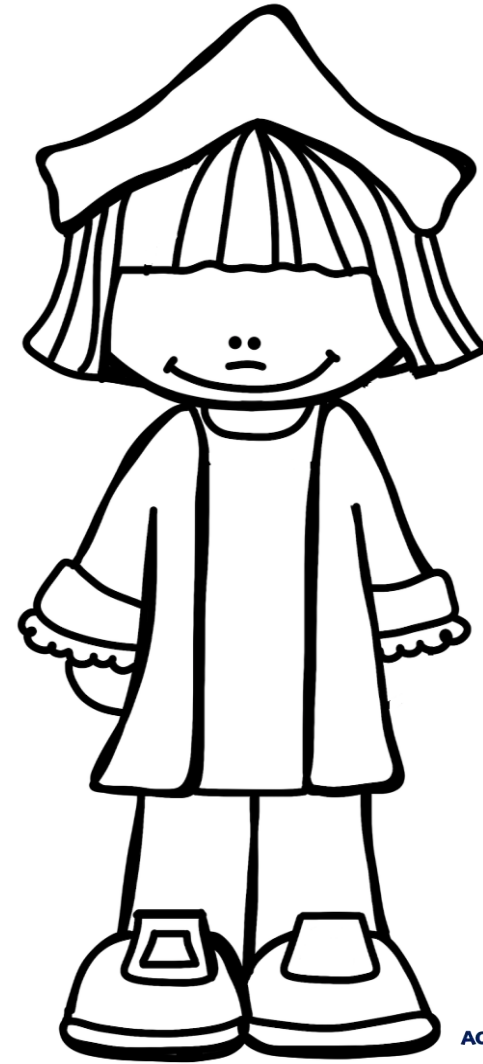
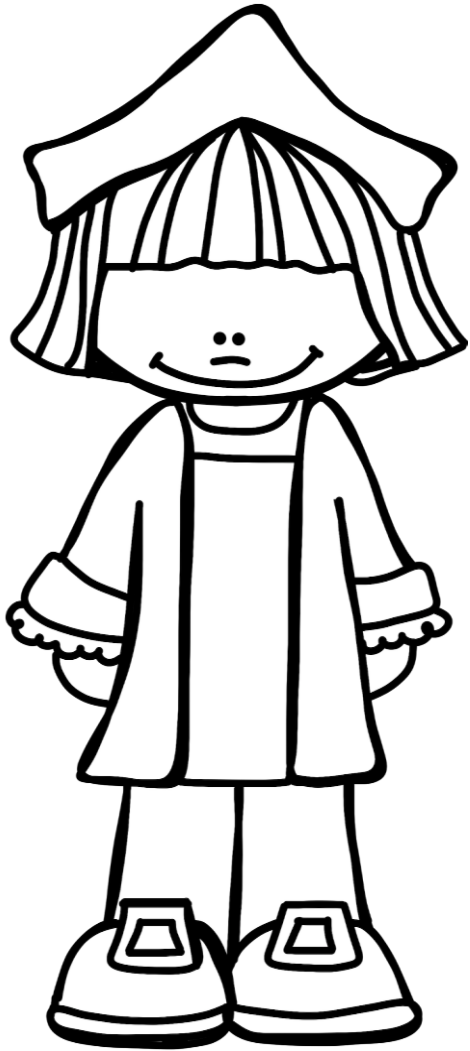

Busca las 5 diferencias y colorea



Busca las 5 diferencias y colorea

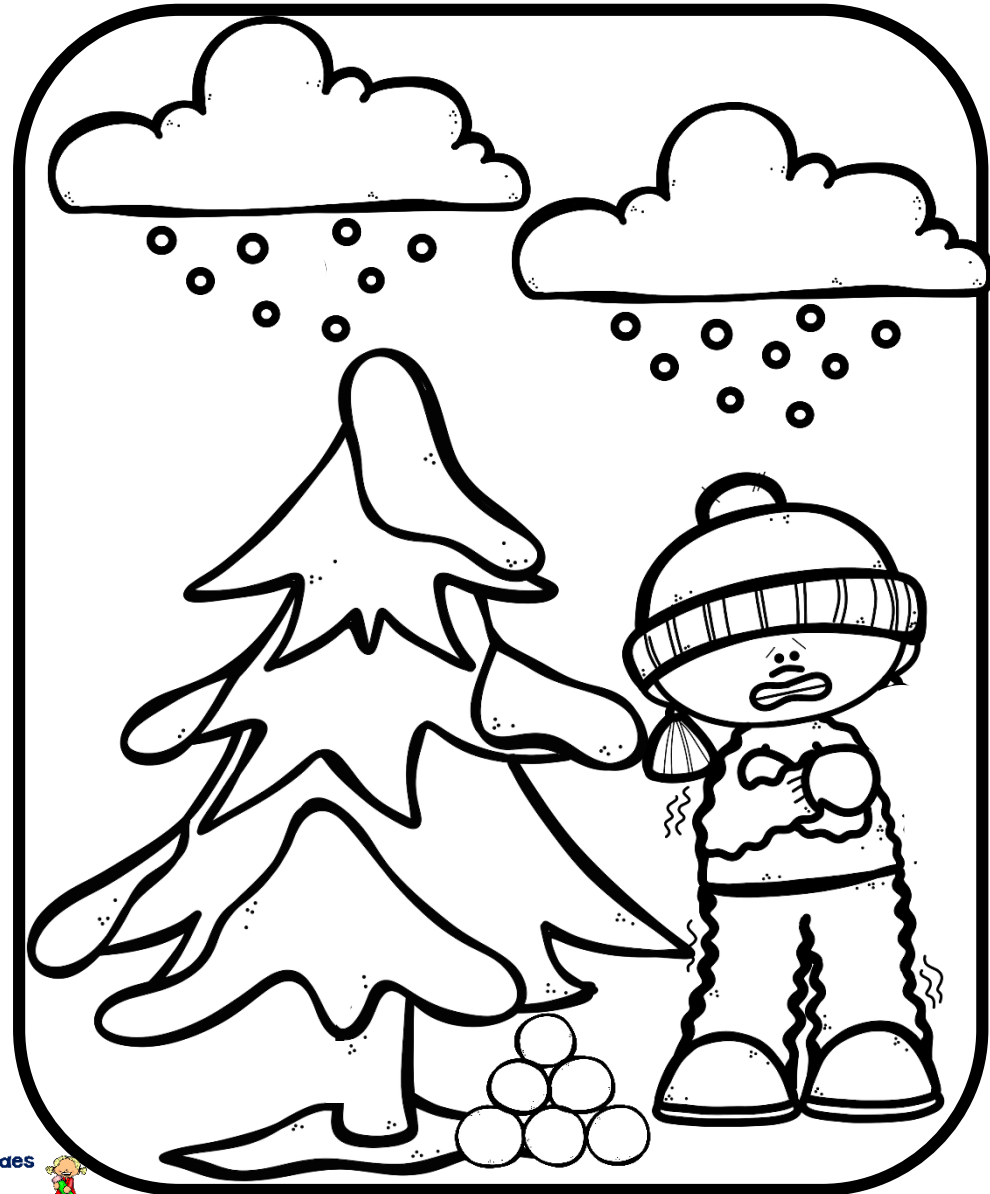

Busca las 5 diferencias y colorea

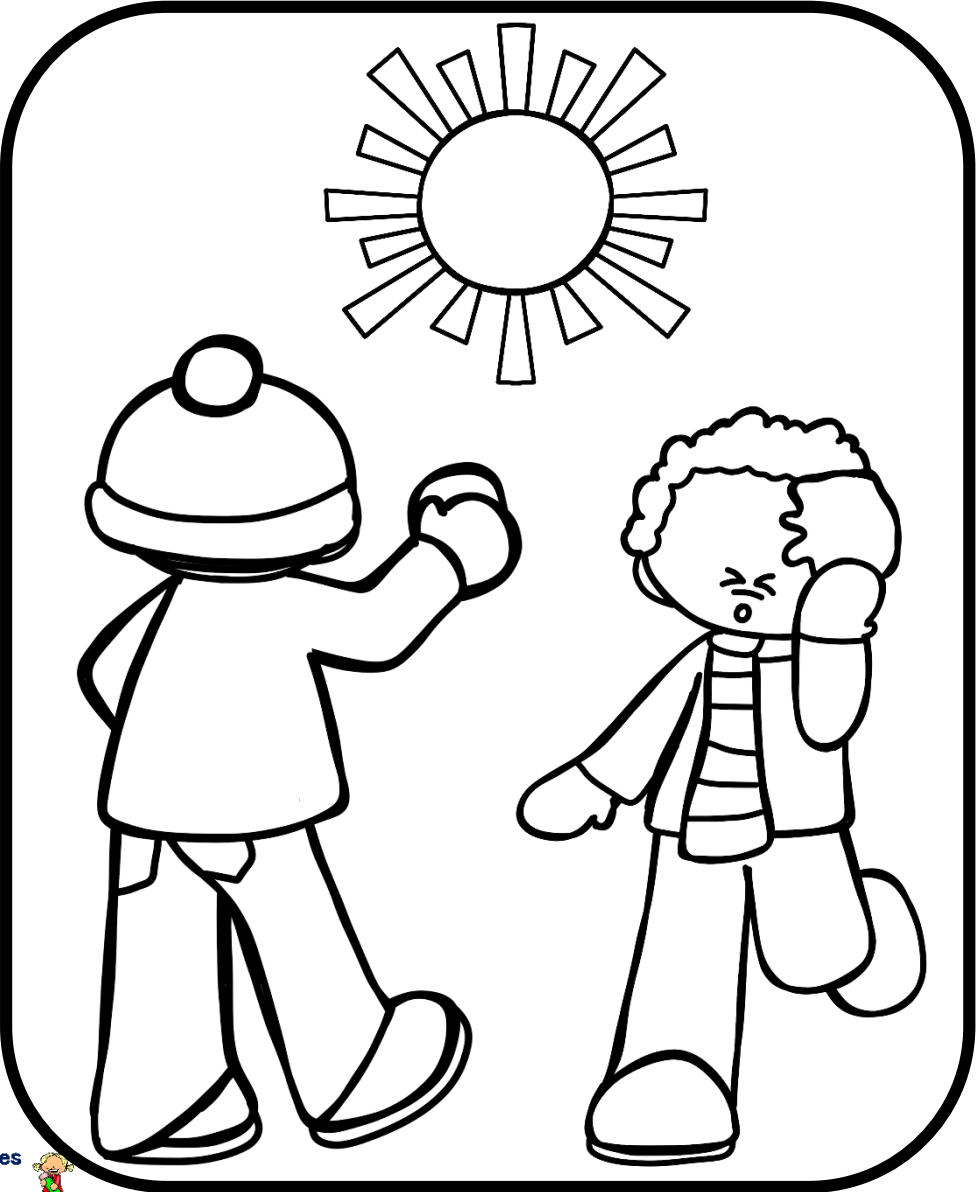
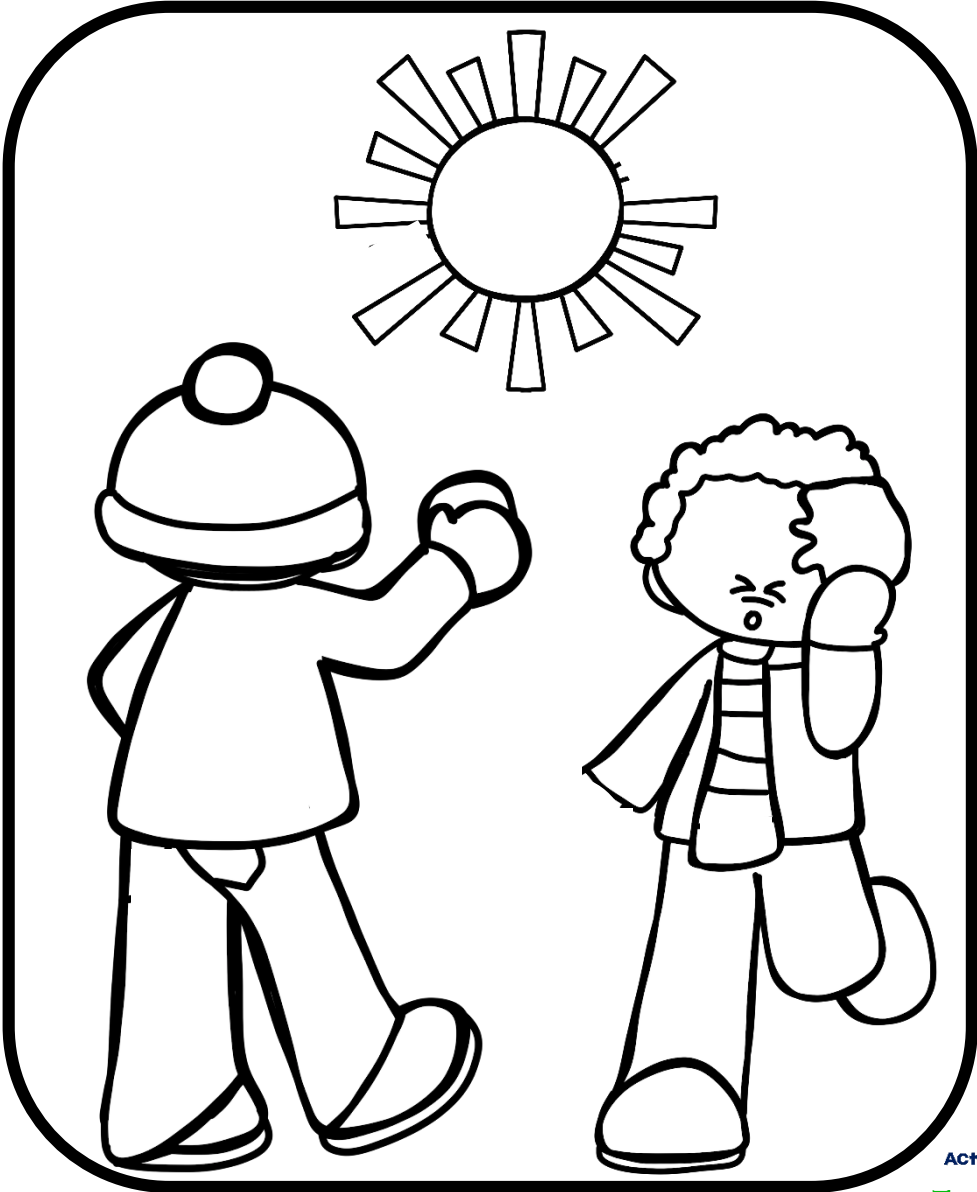

Busca las 5 diferencias y colorea

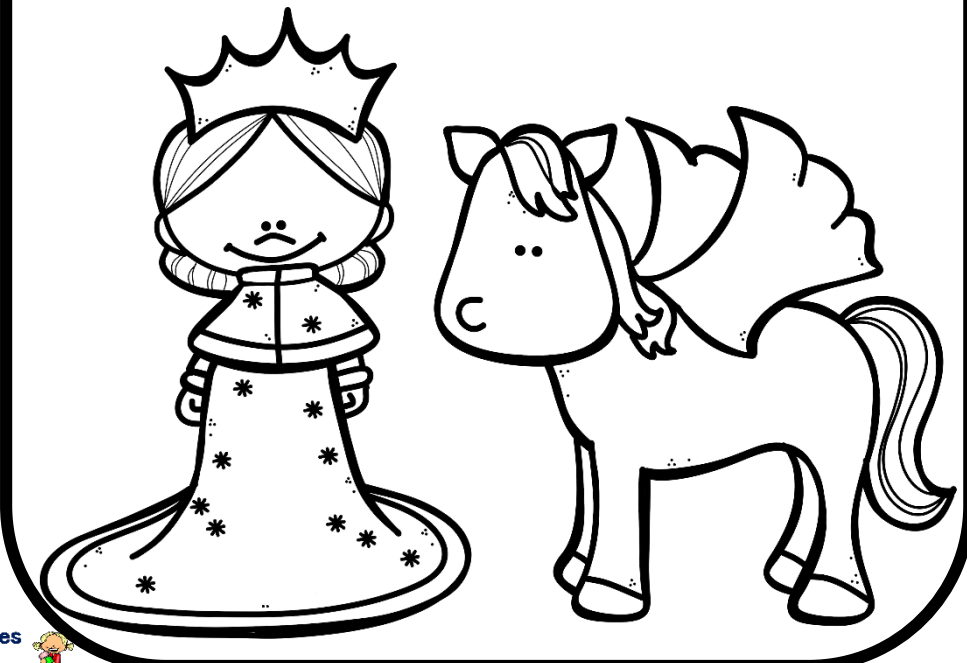
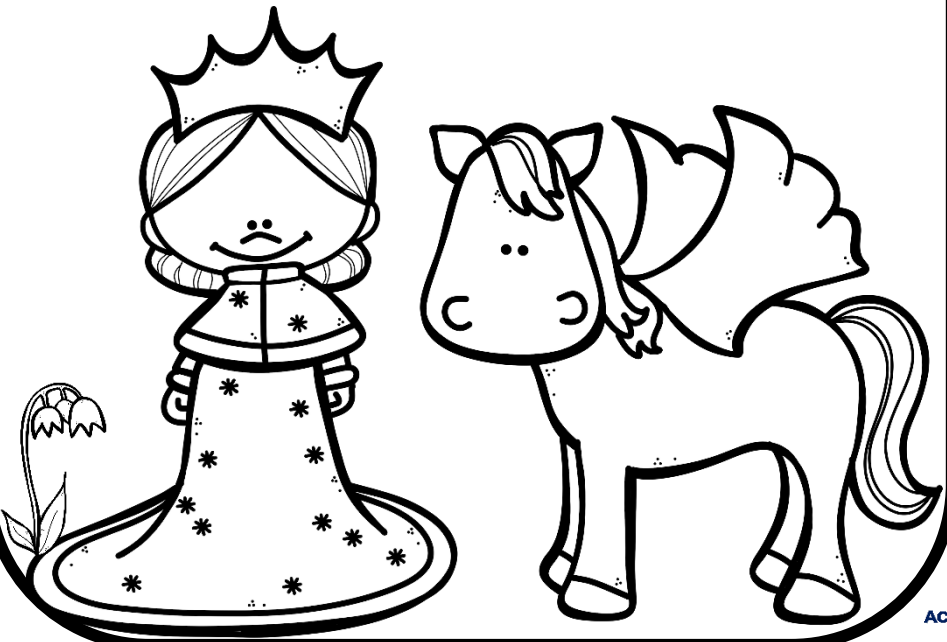

Soluciones



Soluciones

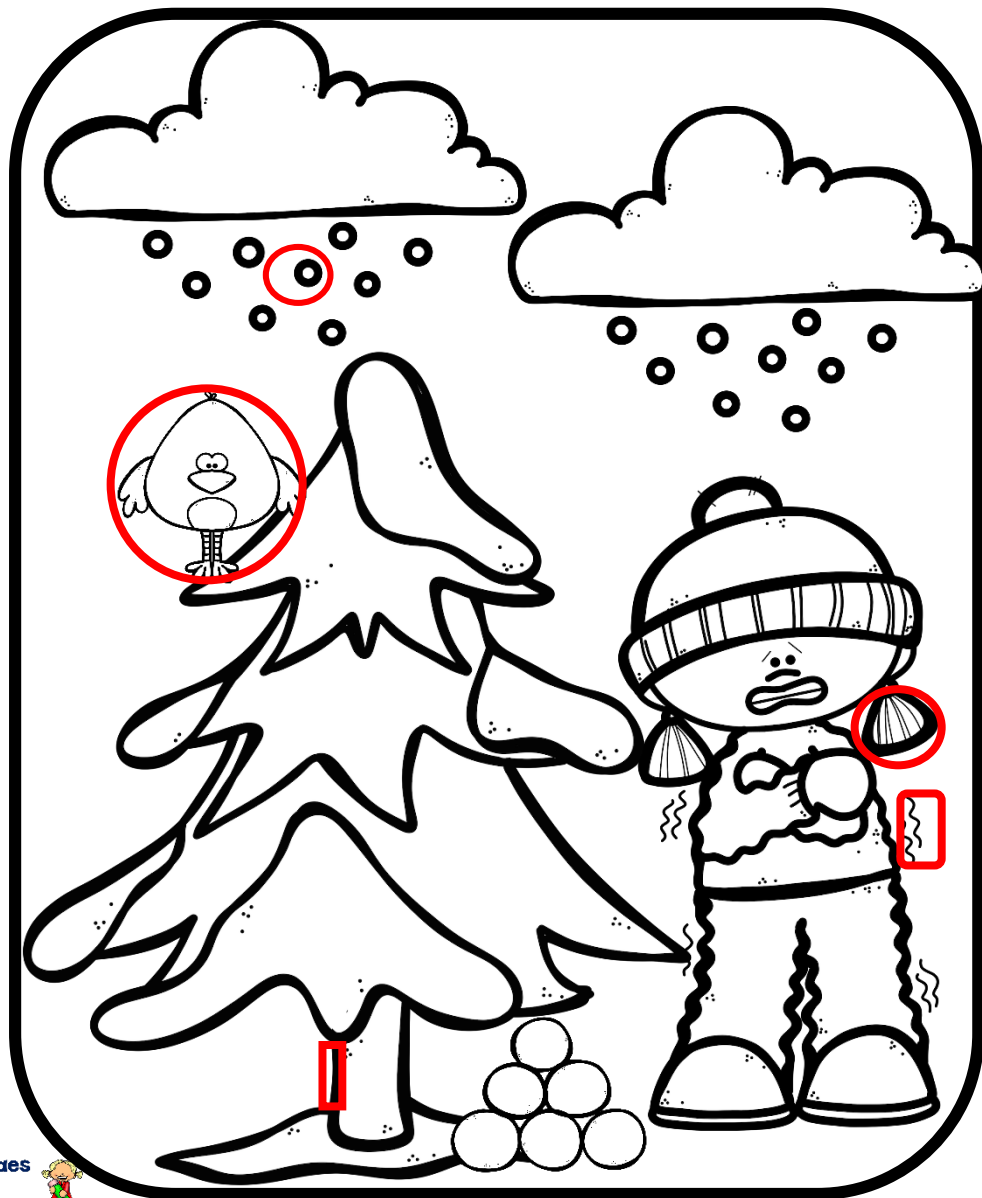

Soluciones

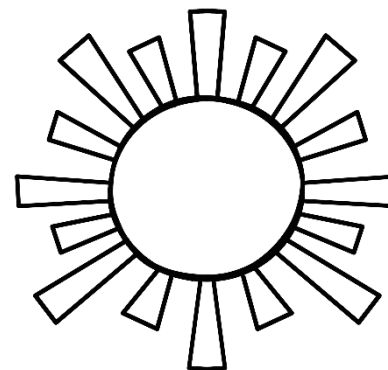
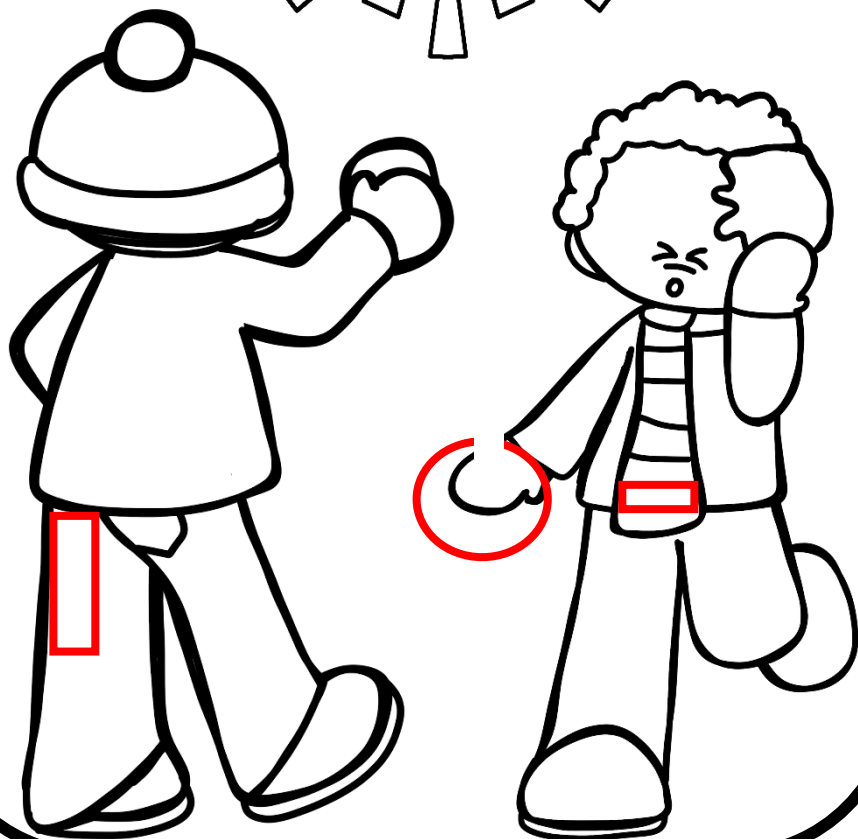
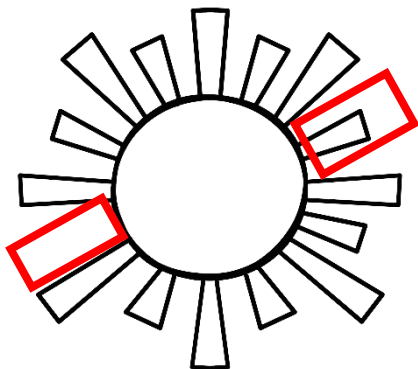

Soluciones

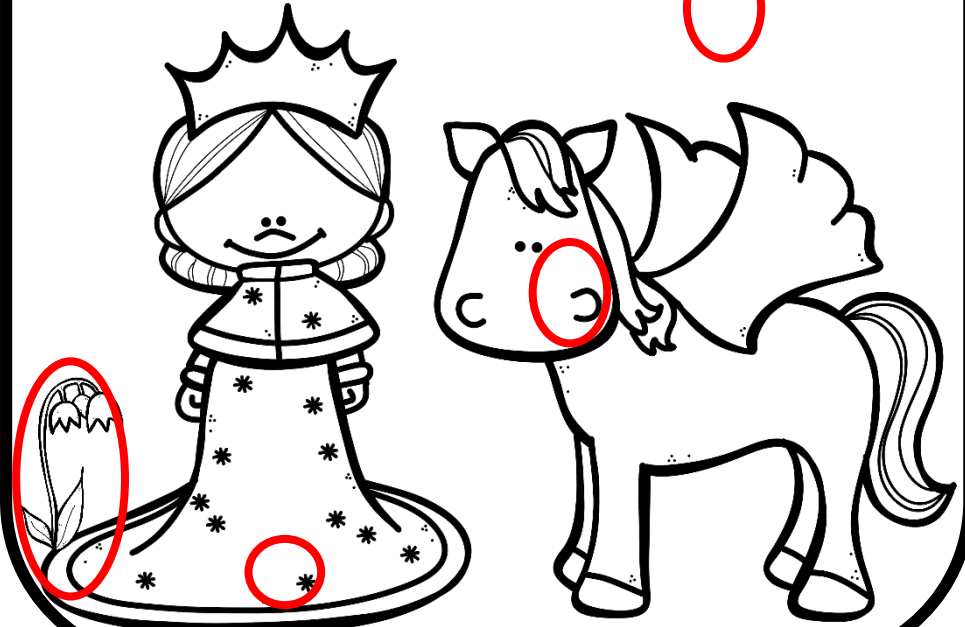
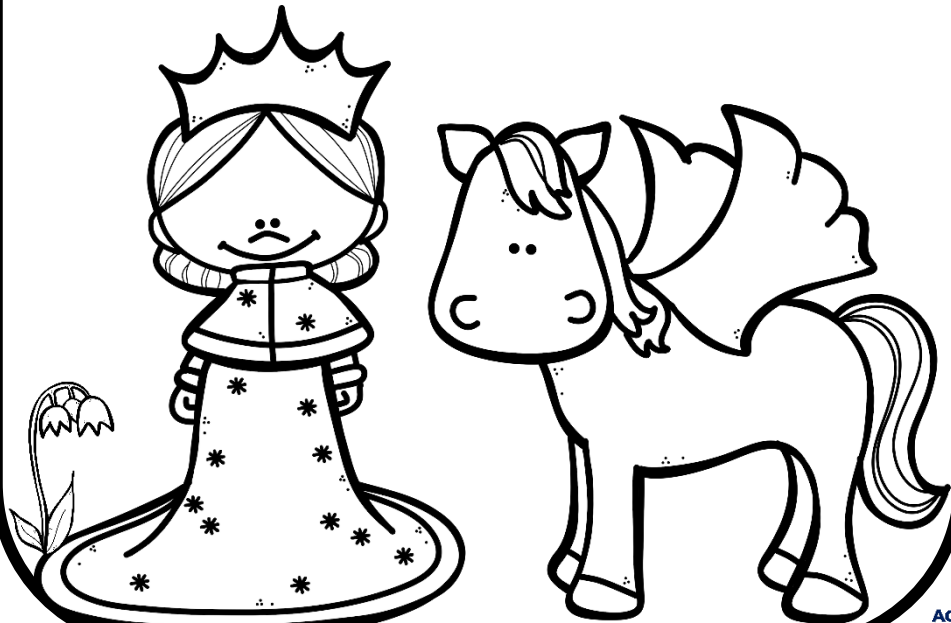
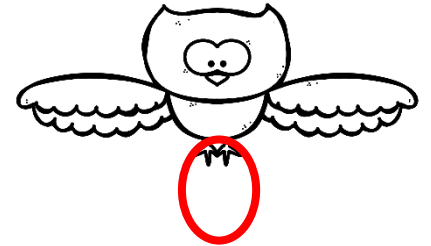
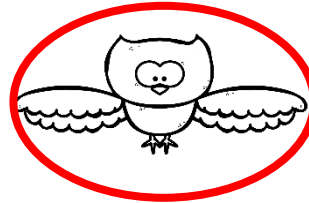
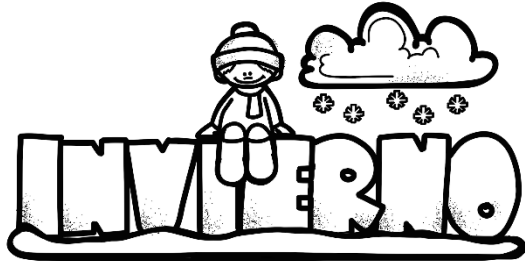

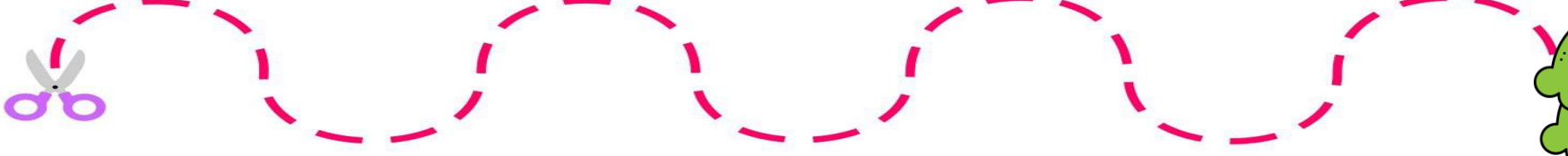
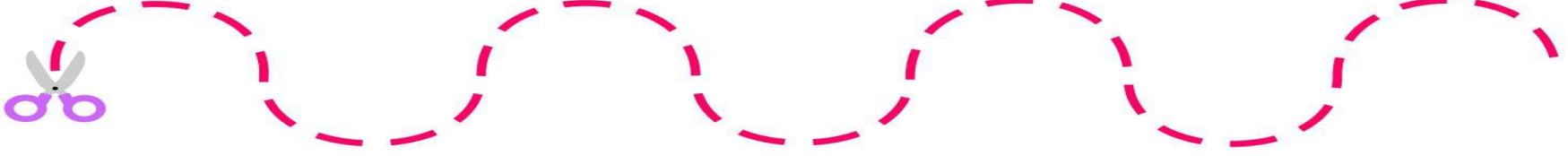
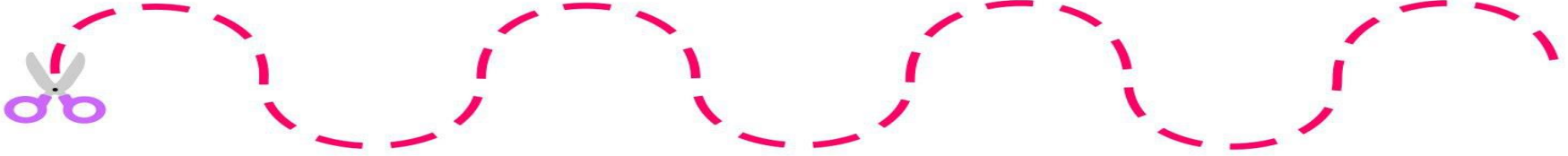
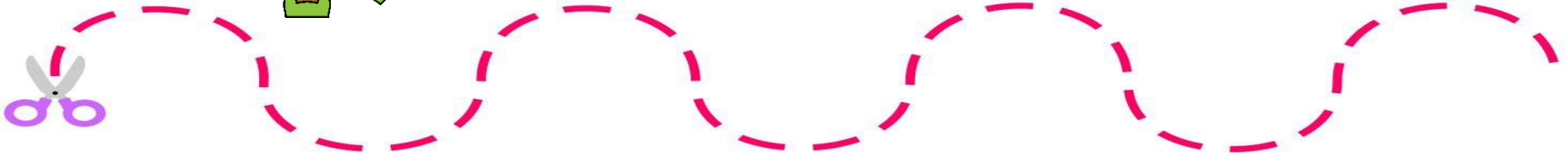

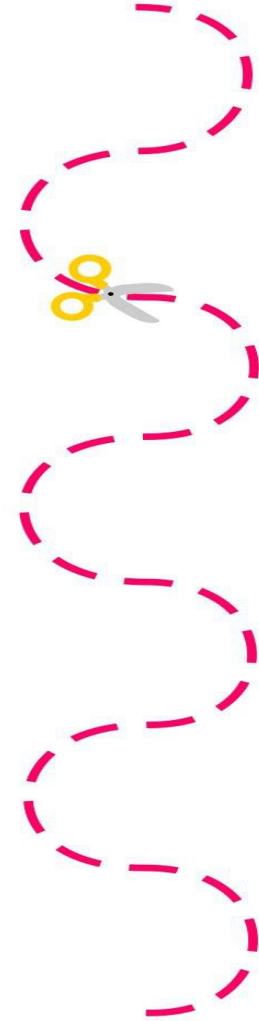
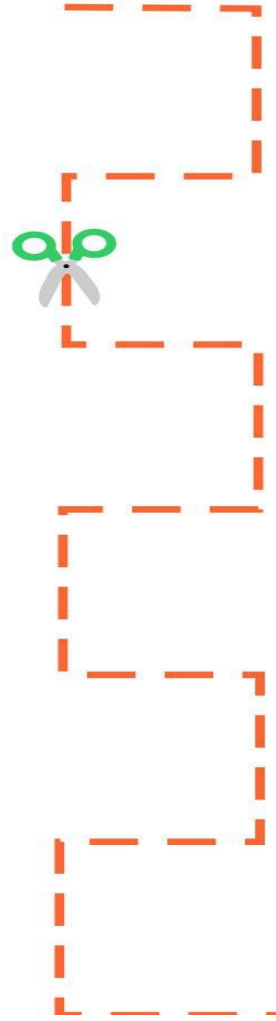
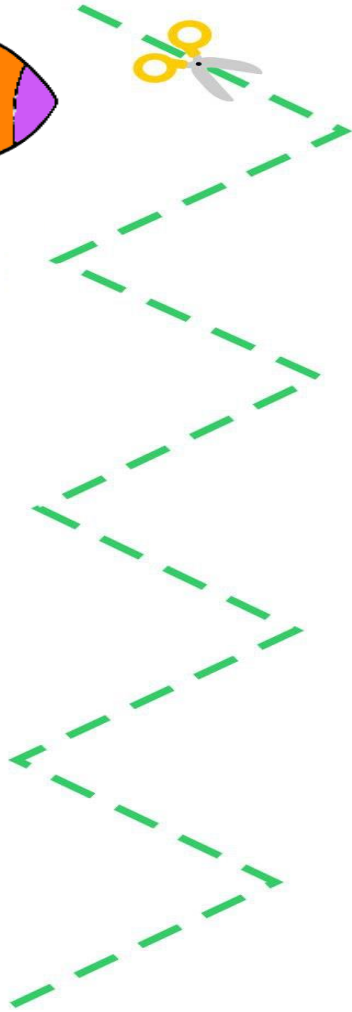
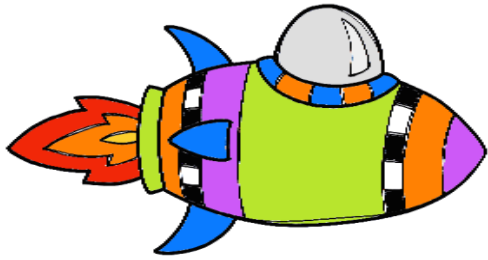

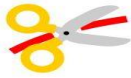

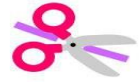
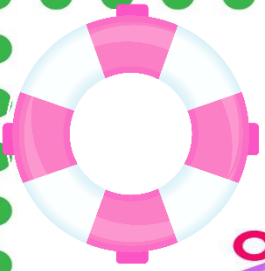



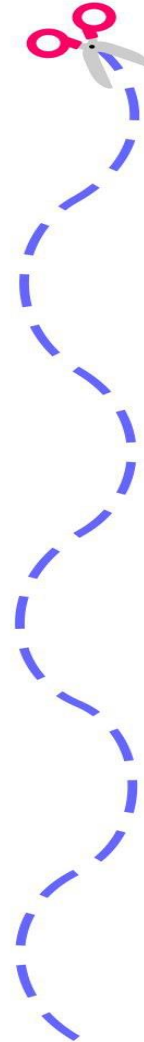
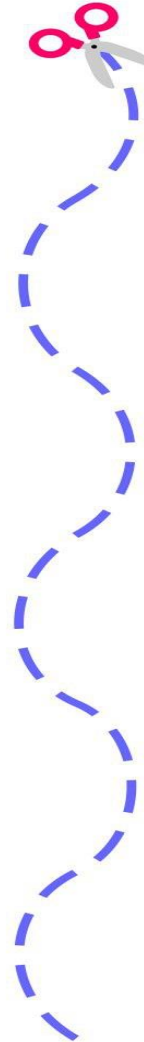
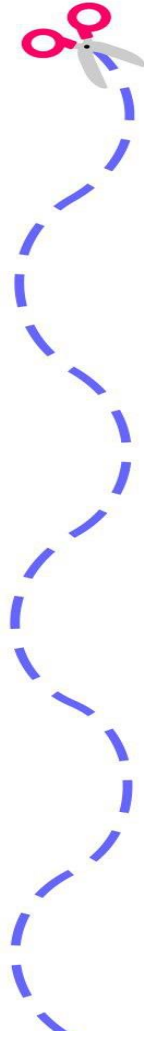
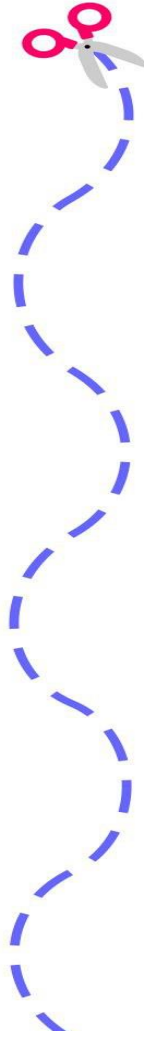
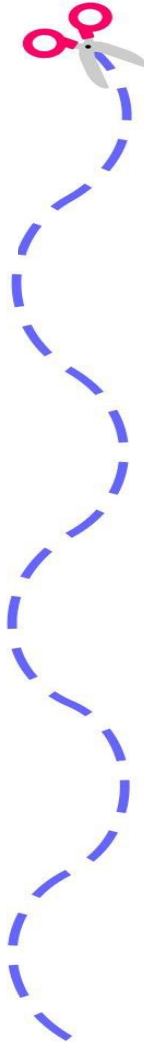
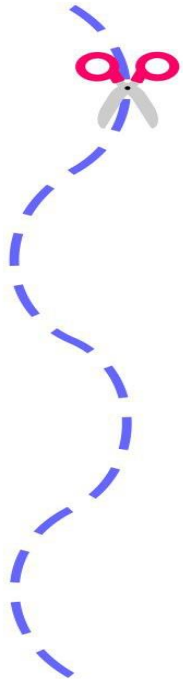

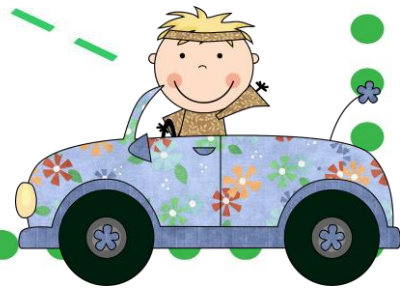
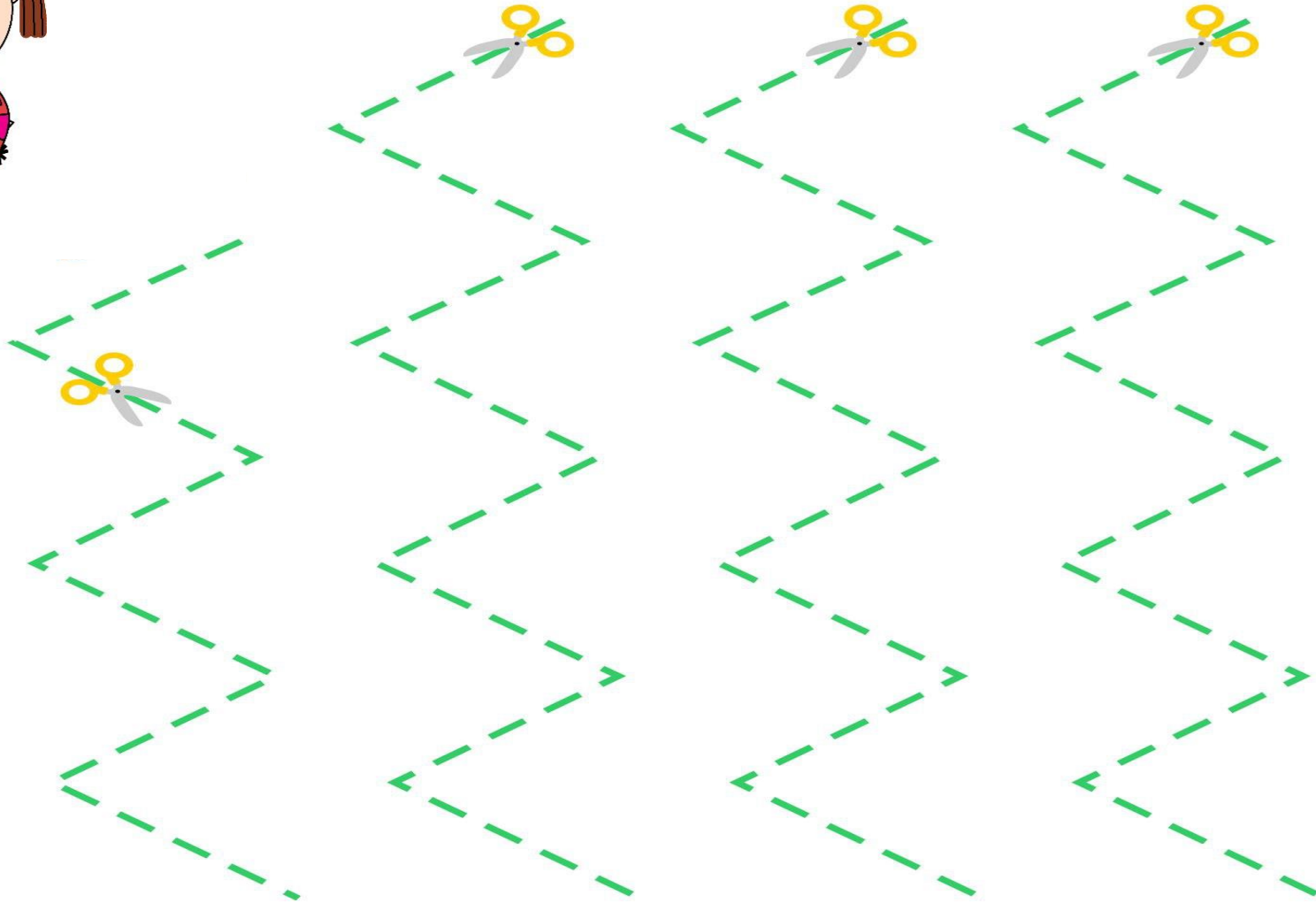



1

2

3

4

5

6

7

8

9

10

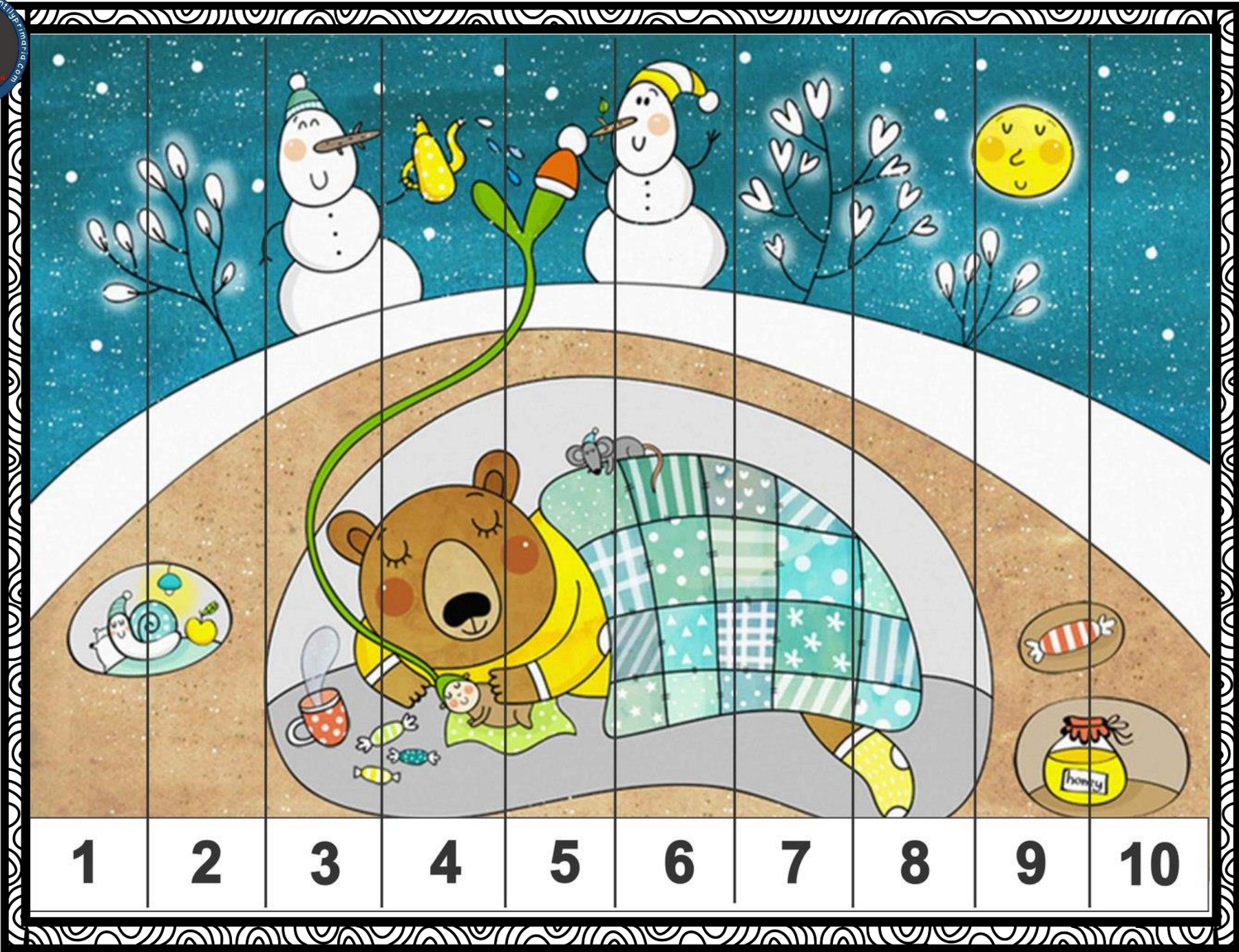

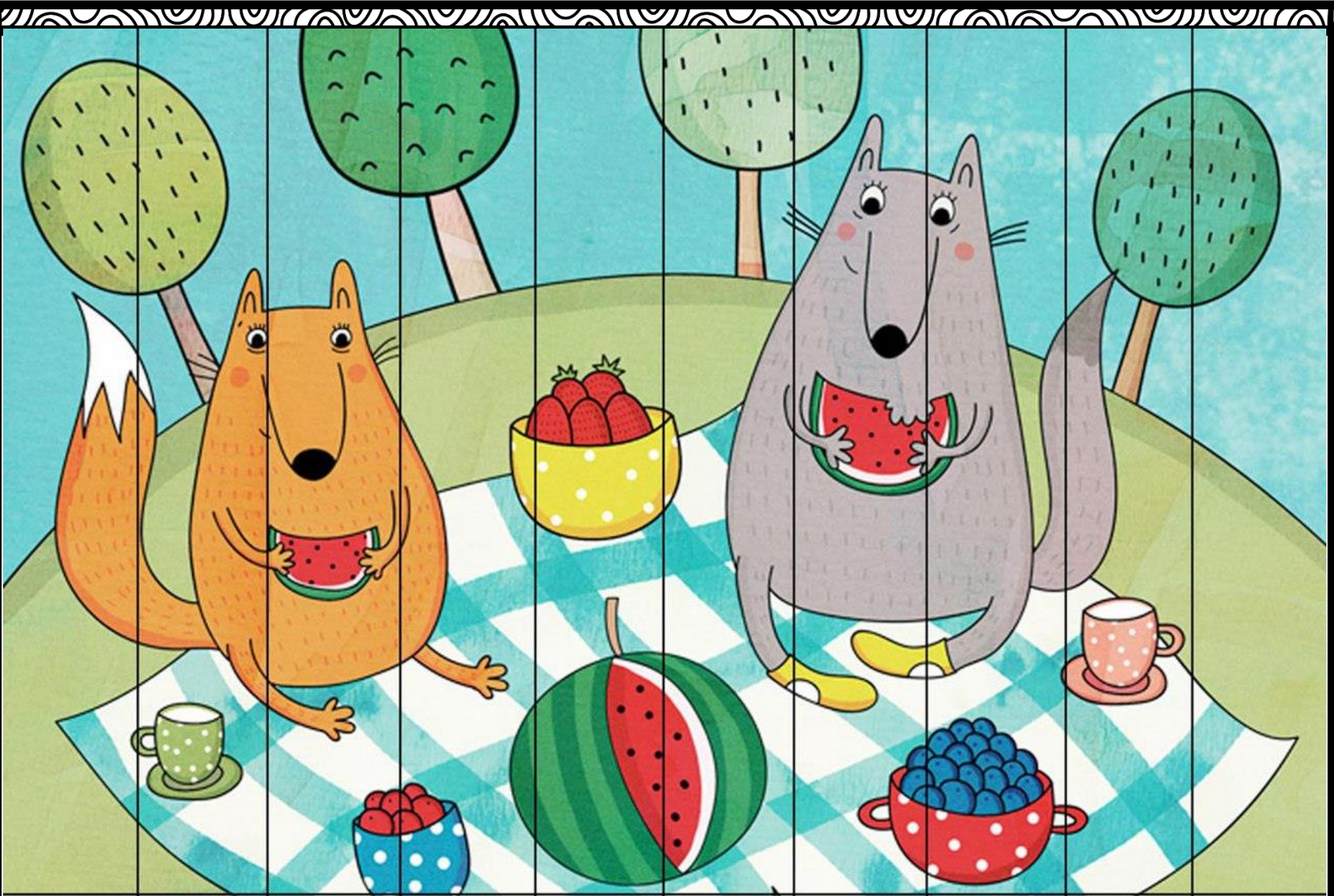

1

2

3

4

5

6

7

8

9

10





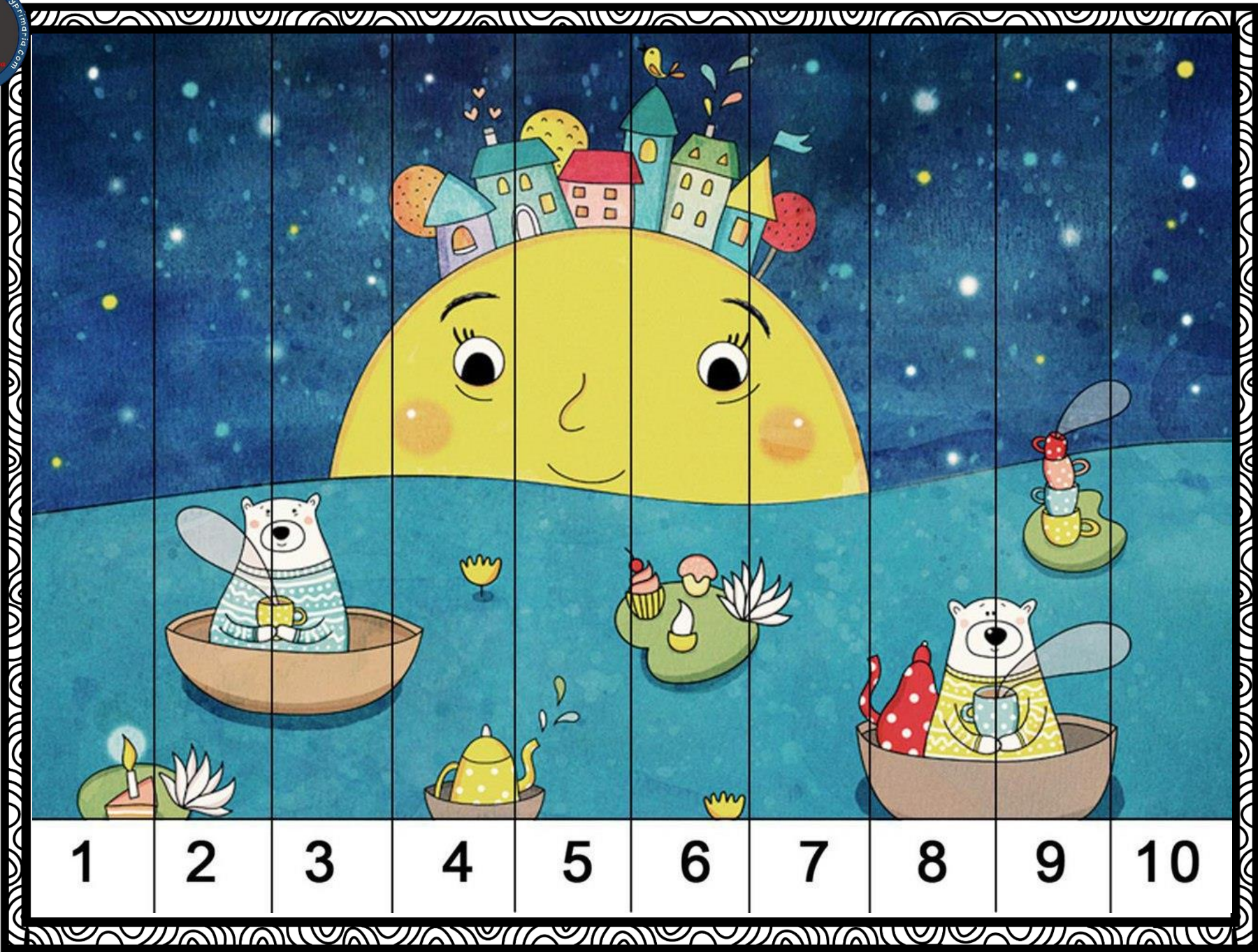

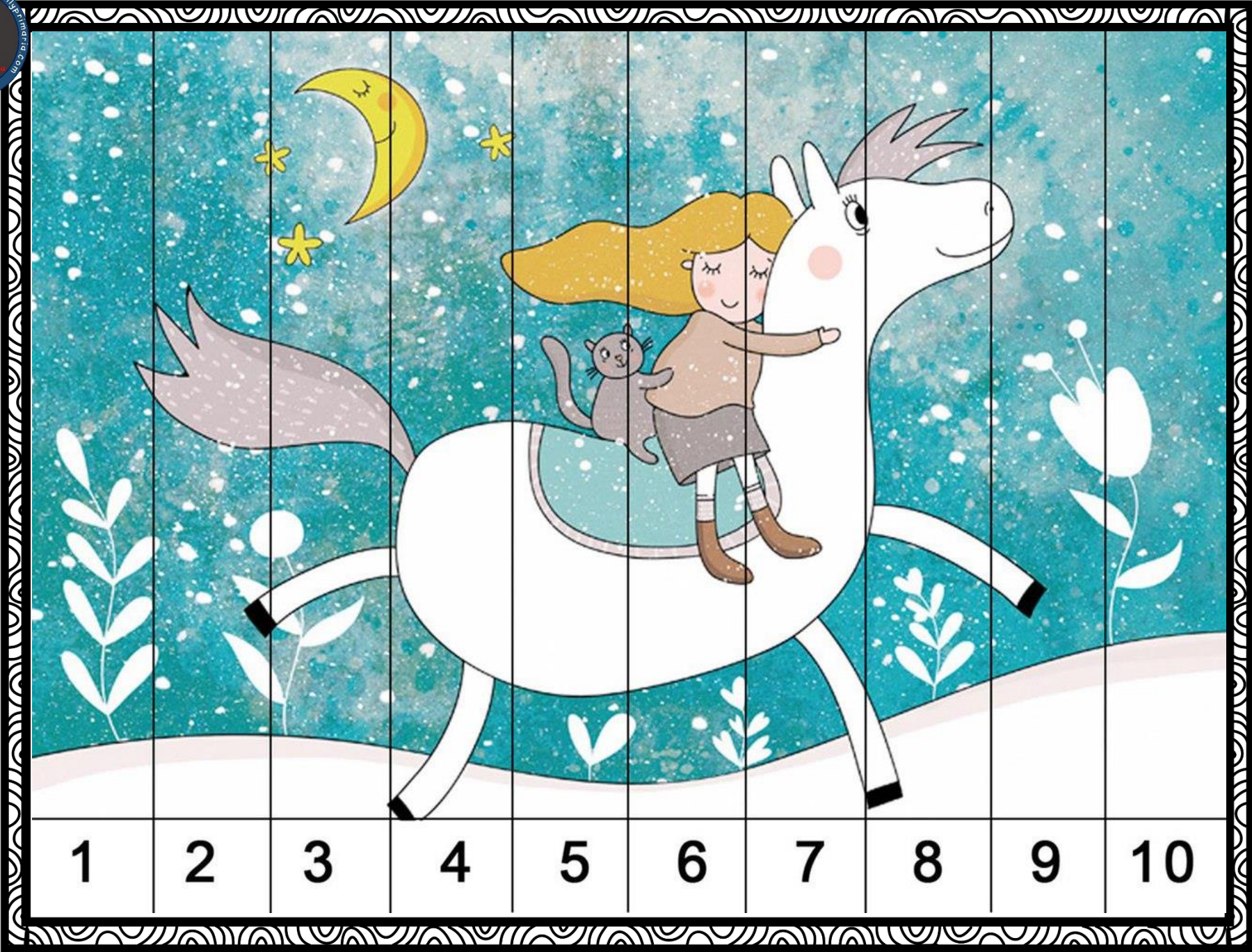



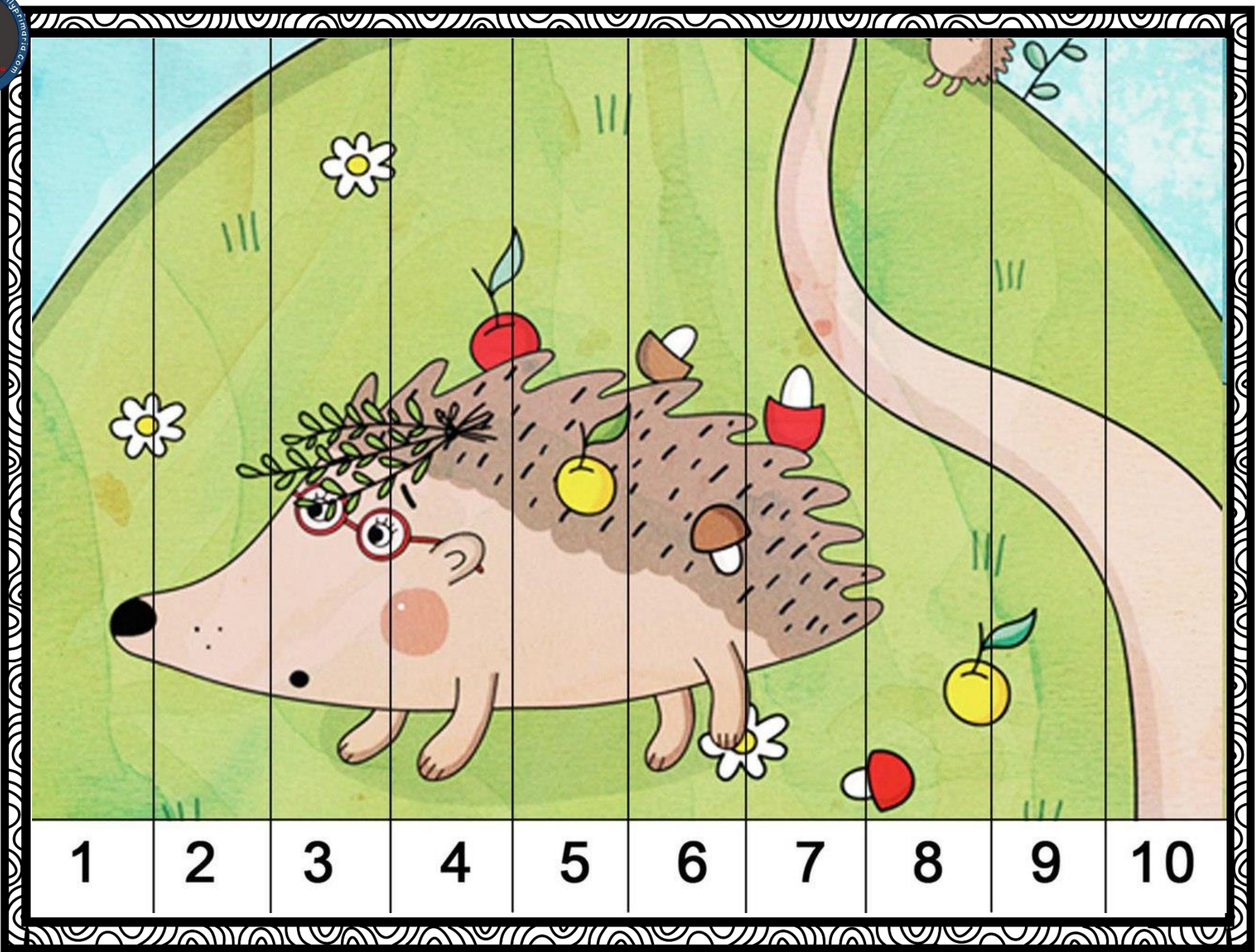

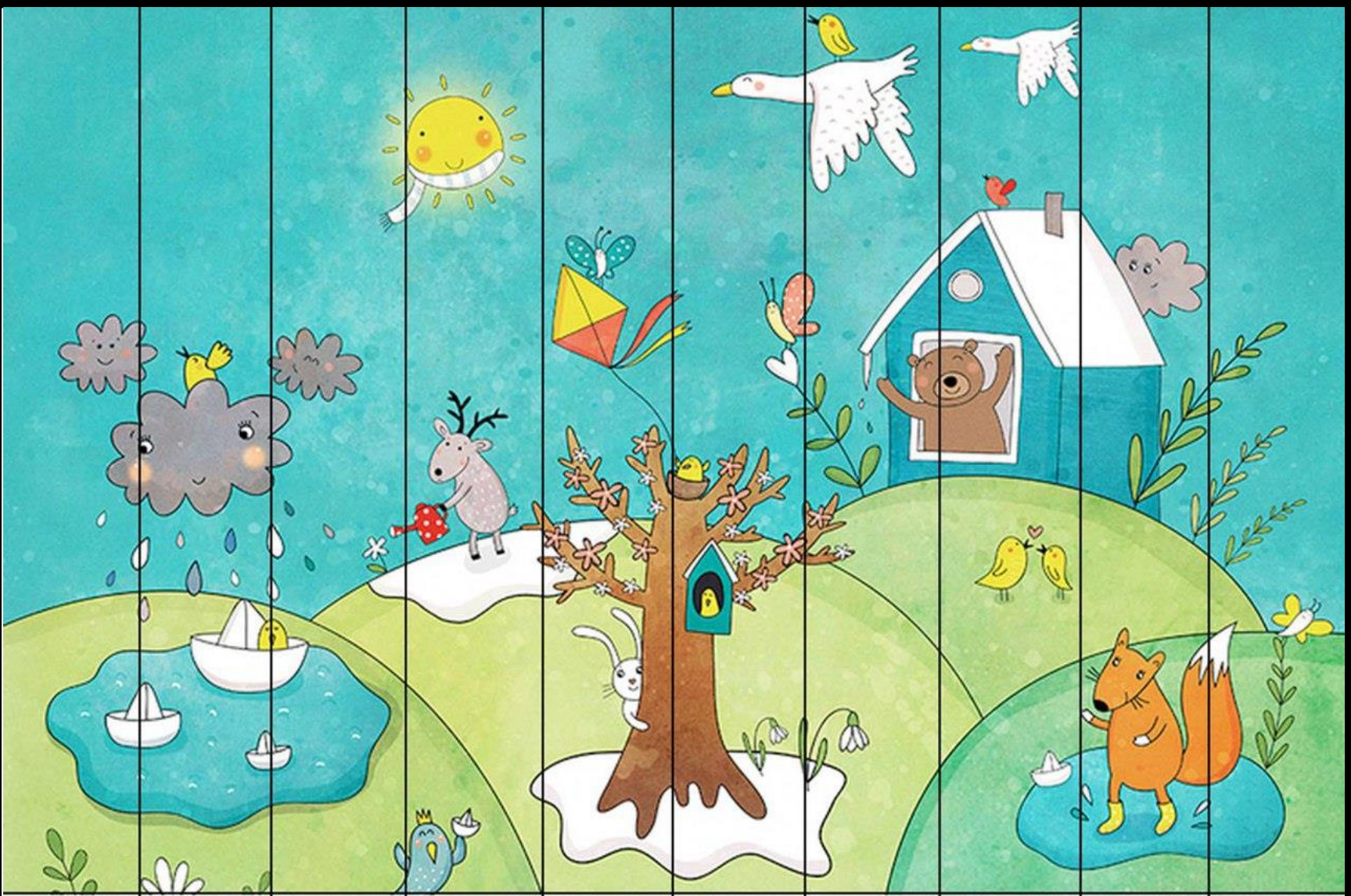

1

2

3

4

5

6

7

8

9

10

Lee el mini relato, recorta, clasifica y pega las
secuencias en el orden correcto.

Imágenes
Educativas.com

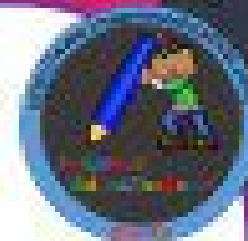

Hansel y Gretel se perdieron caminando por el bosque,
encontrando una casita de chocolate, donde vivía una bruja
malvada que se los quería comer, pero Gretel la tiro dentro
de la chimenea, y los dos hermanos se escaparon.

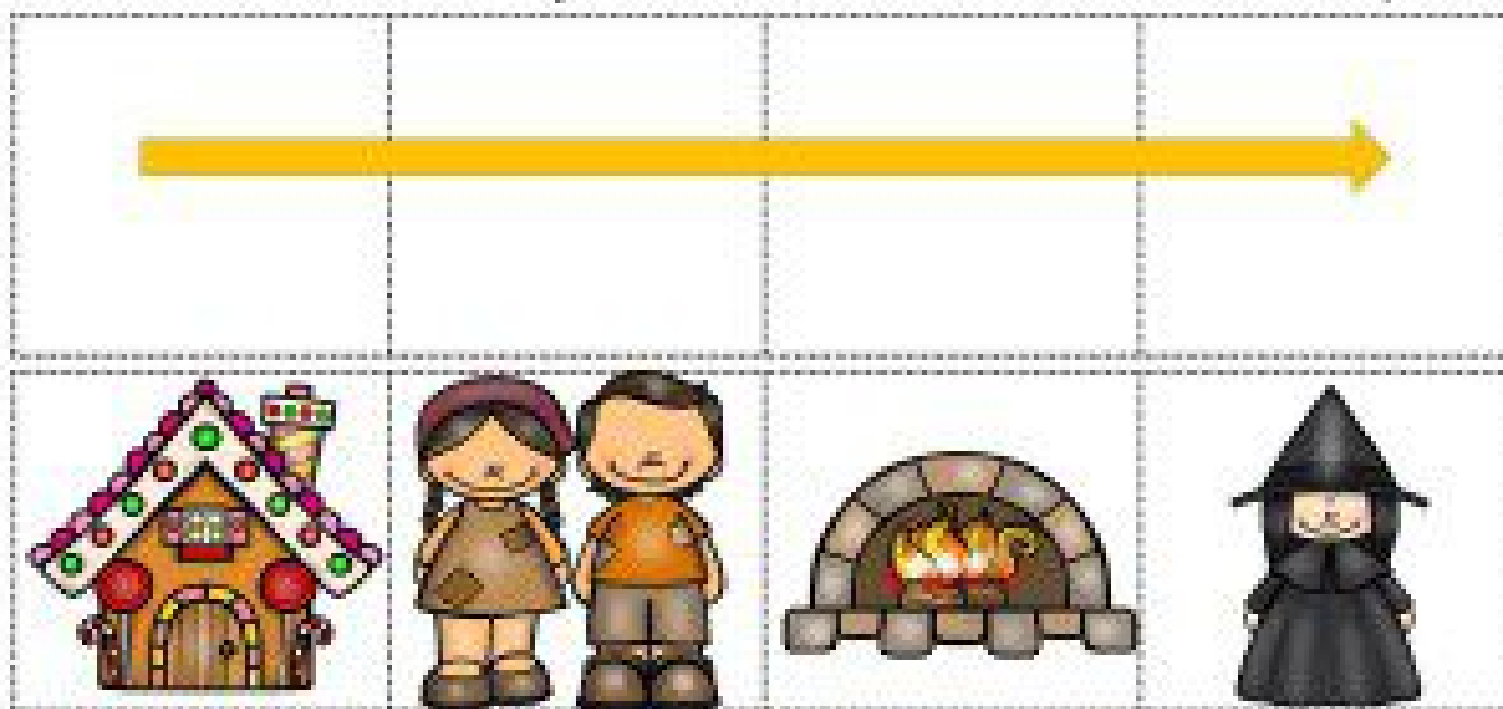

Lee el mini relato, recorta, clasifica y pega las
secuencias en el orden correcto.

Imágenes
Educativas.com

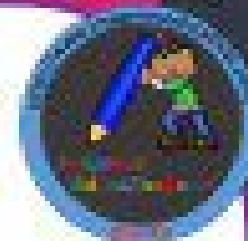

Los tres cerditos Vivian felices en el bosque, allí habían
construido sus casas de paja, medar y ladrillos el lobo
malvado se los quería comer pero el cerdito mayor le quemó
el culito con un caldero hirviendo.

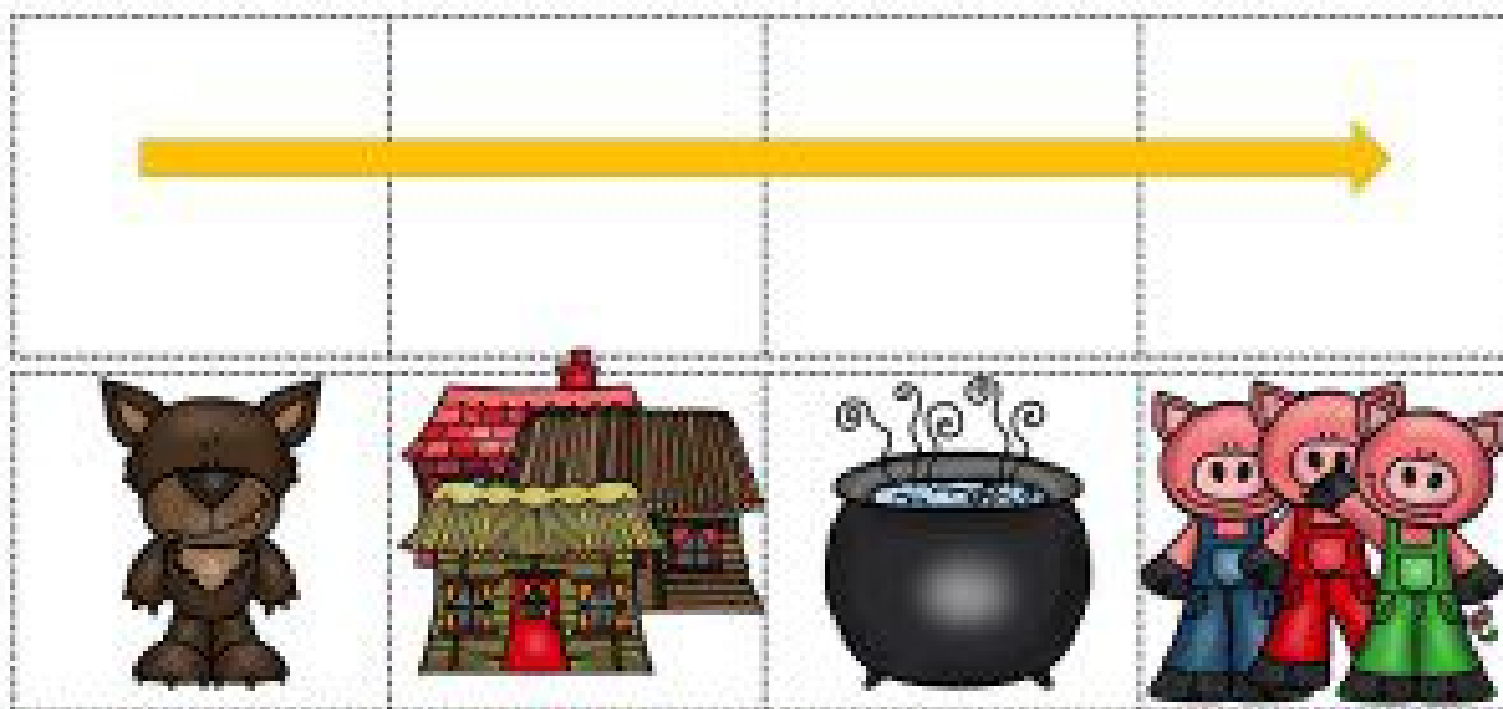

Lee el mini relato, recorta, clasifica y pega las
secuencias en el orden correcto.

Imágenes
Educativas.com

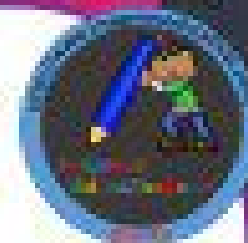

En diciembre comienza la navidad, los niños cantan villancicos por las calles, y dentro de las casas se coloca el árbol de navidad, el día 25 por la noche Papa Noel reparte los regalos a los niños que se han portado bien.



Lee el mini relato, recorta, clasifica y pega las
secuencias en el orden correcto.

En la edad media la gente vivía en los castillos, en ellos
mandada el rey y la reina, para las grandes celebraciones
hacían torneos de caballeros y por las noches se celebraban
grandes banquetes, amenizados por los bufones
