

ÍNDICE DE ACTIVIDADES

GRAFOMOTRICIDAD

Ficha

• Almenas	1
• Aspas	2
• Líneas inclinadas continuas	3
• Semicírculos	4
• Semicírculos y círculos	5
• Semicírculos continuos	6
• Círculos	7
• Espirales	8
• Bucles	9
• Bucles	10
• Bucles continuos	11
• Bucles continuos	12
• Bucles	13
• Preescritura i. Cenefas	14
• Cenefas preescritura	15
• Onduladas	16

MATEMÁTICAS

• Círculo	17
• Cuadrado	18
• Triángulo	19
• Cuadrado y triángulo	20
• Rectángulo	21
• Copia de dibujo con formas geométricas	22
• Círculo y óvalo	23
• Esfera	24
• Cubo	25
• Números 1, 2 y 3	26
• Número 4	27
• Número 5	28
• Números 4 y 5	29
• Número 6	30
• Serie numérica del 1 al 6	31

CONCEPTOS BÁSICOS

Ficha



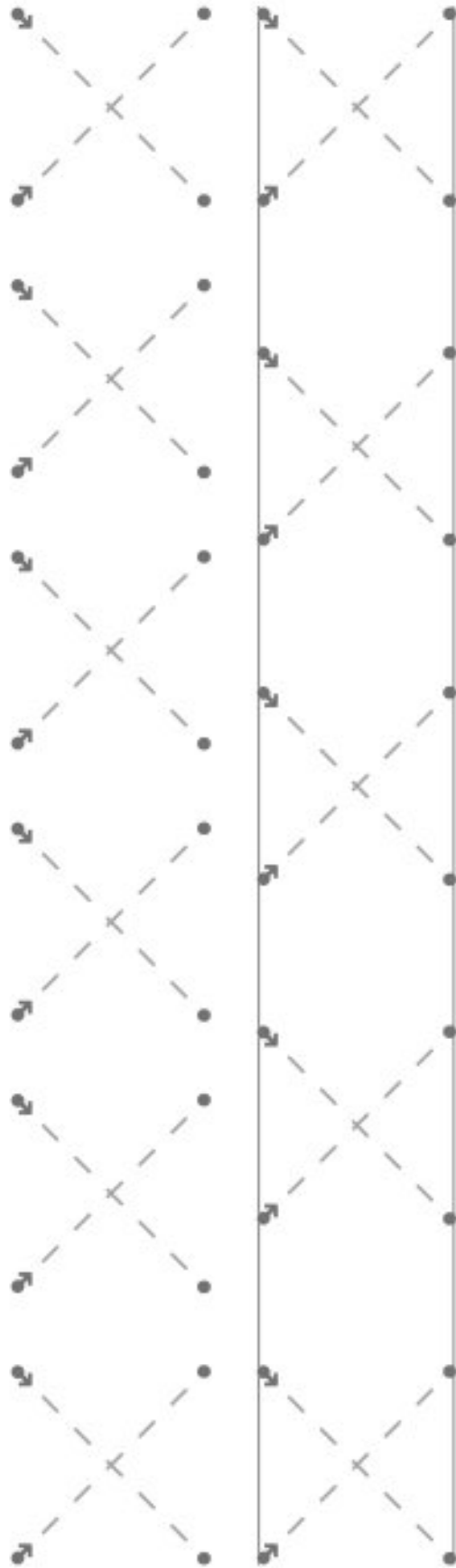
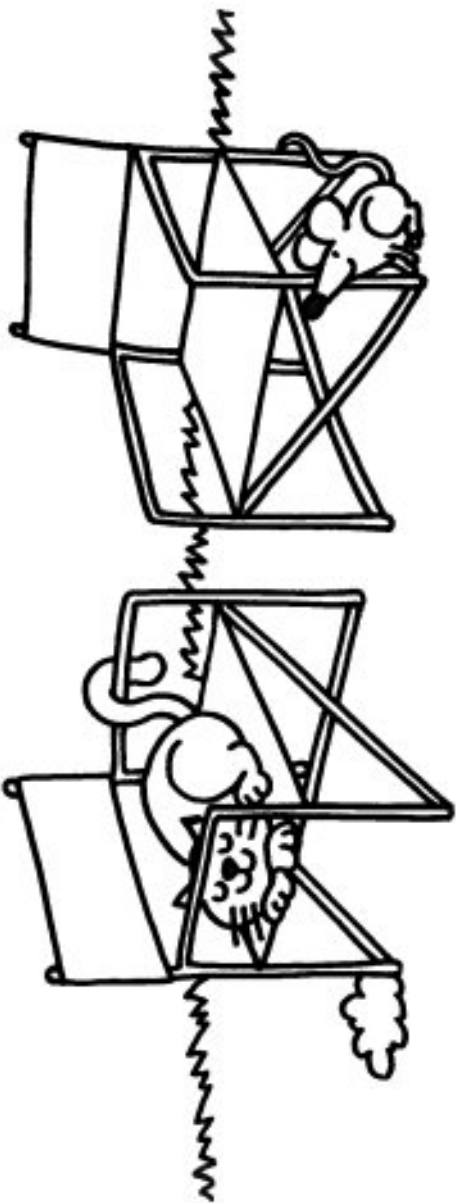

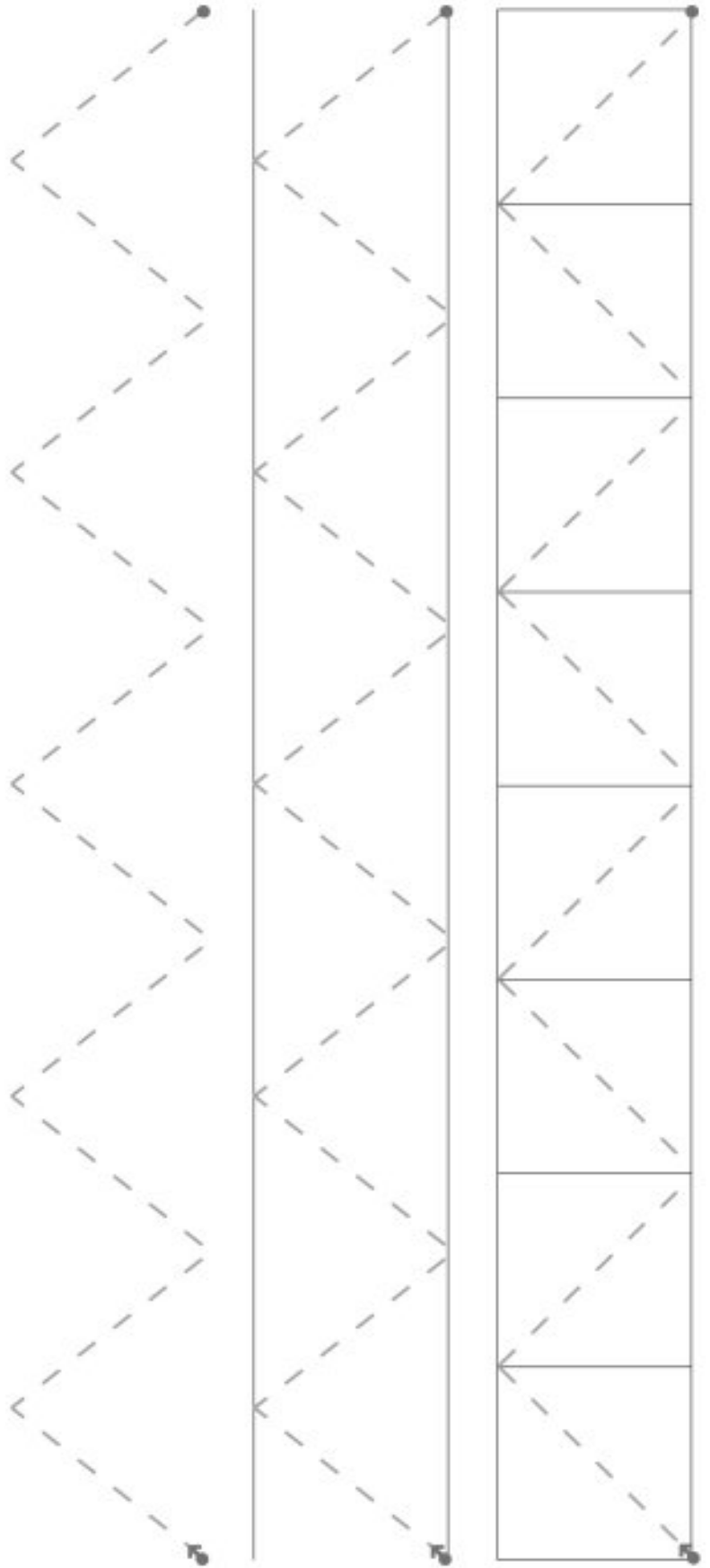

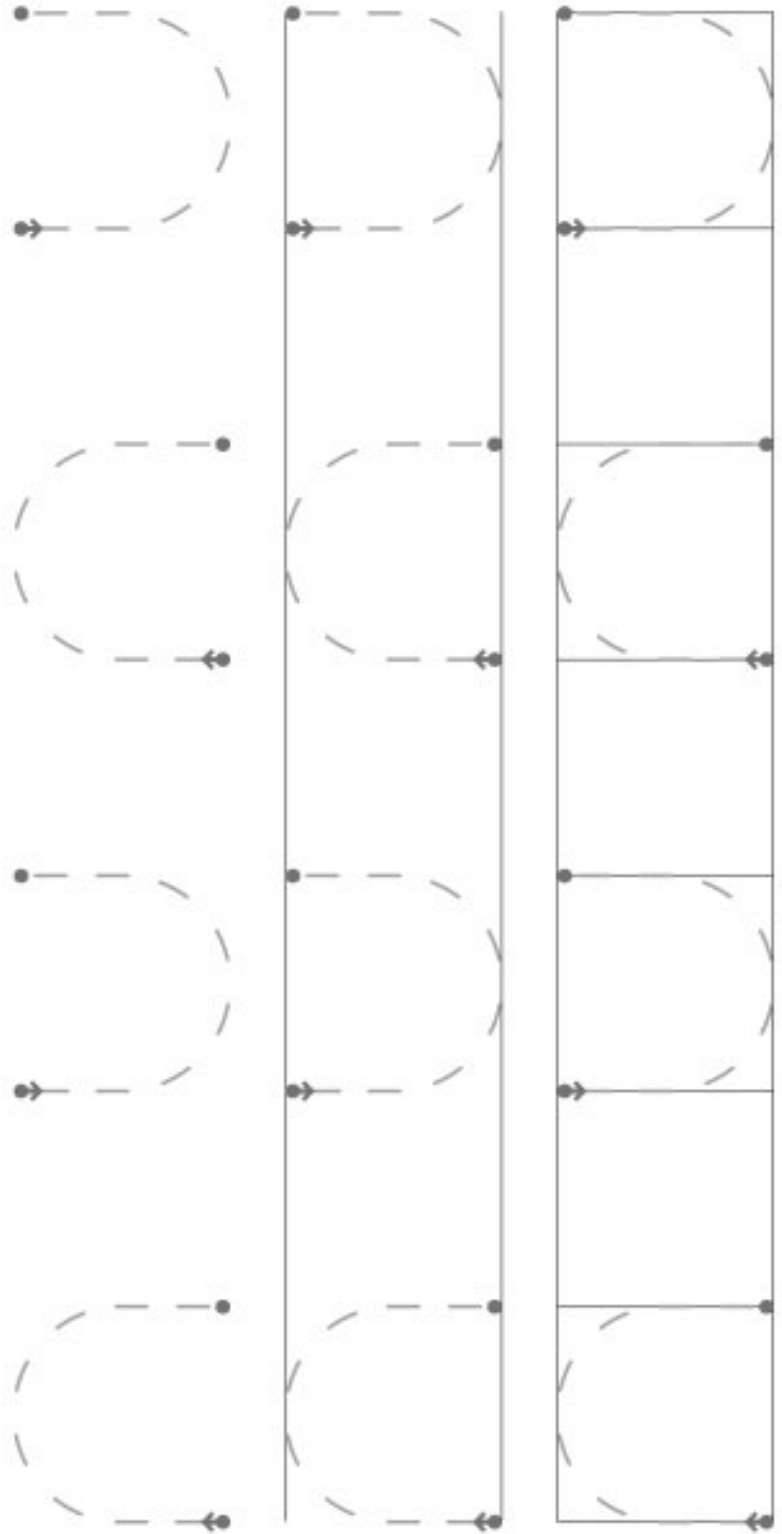
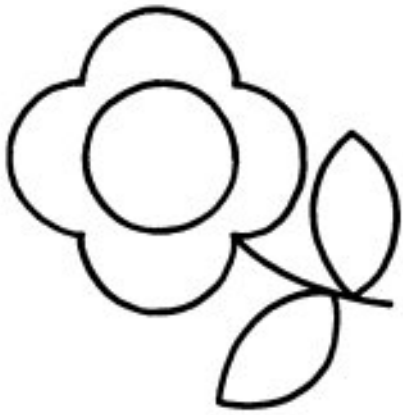





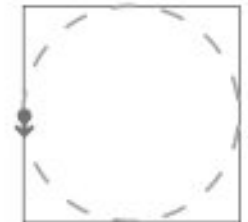

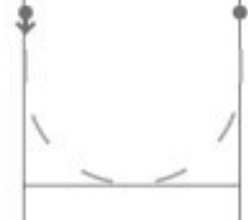
• Simetría	32
• Muchos-pocos	33
• Todas-algunas	34
• Mitad	35
• Ninguna-algunas	36
• Parejas	37
• Relacionar cantidad-grafía	38
• Relacionar grafía-cantidad	39
• Serie numérica	40
• Ordinales 1.º, 2.º y 3.º	41
• Descomposición del 4 y del 5	42
• Más	43
• Menos	44
• Igual	45
• Ordinales 1.º, 2.º y 3.º	46
• Suma en horizontal	47
• Sumas en vertical	48
• Sumas en horizontal	49
• Líneas abiertas y cerradas	50
• Simetrías en el cuerpo	51
• En medio	52
• Arriba, encima, debajo	53
• Dentro-fuera	54
• Dentro-fuera	55
• Dentro respecto a líneas abiertas y cerradas	56
• Delante-detrás	57
• Juntas-separadas	58
• Alrededor	59
• Largo-corto	60
• Ancho-estrecho	61
• Arriba-abajo	62

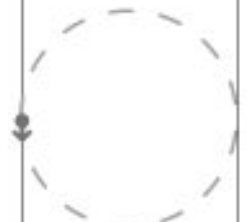
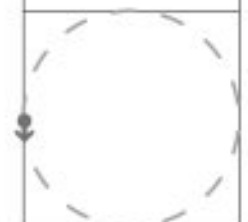

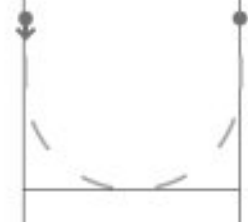

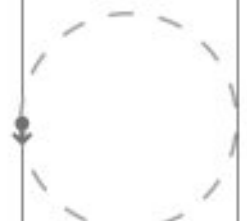
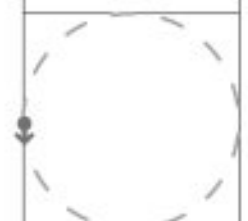



		
		
		
		
		
		

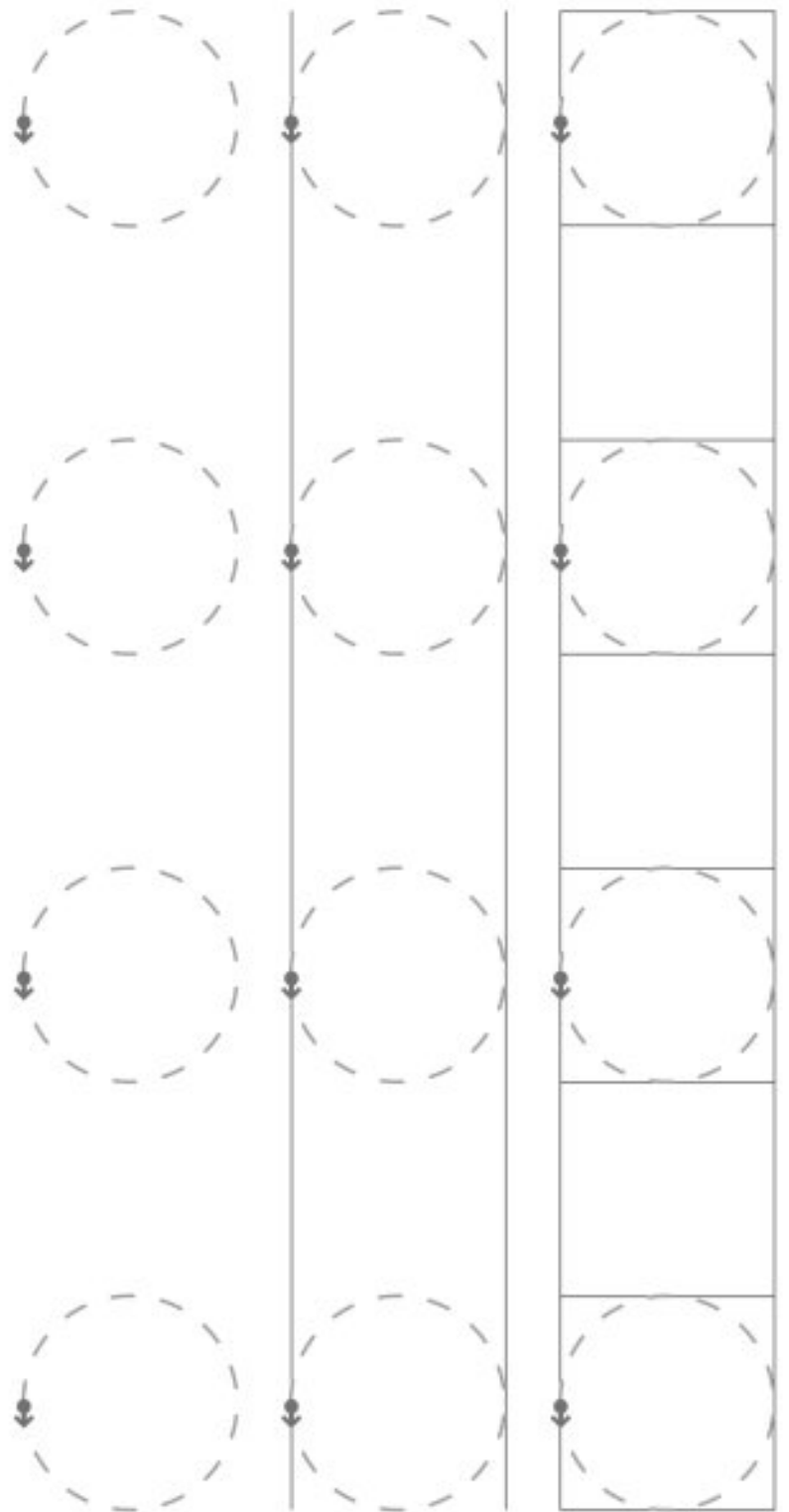
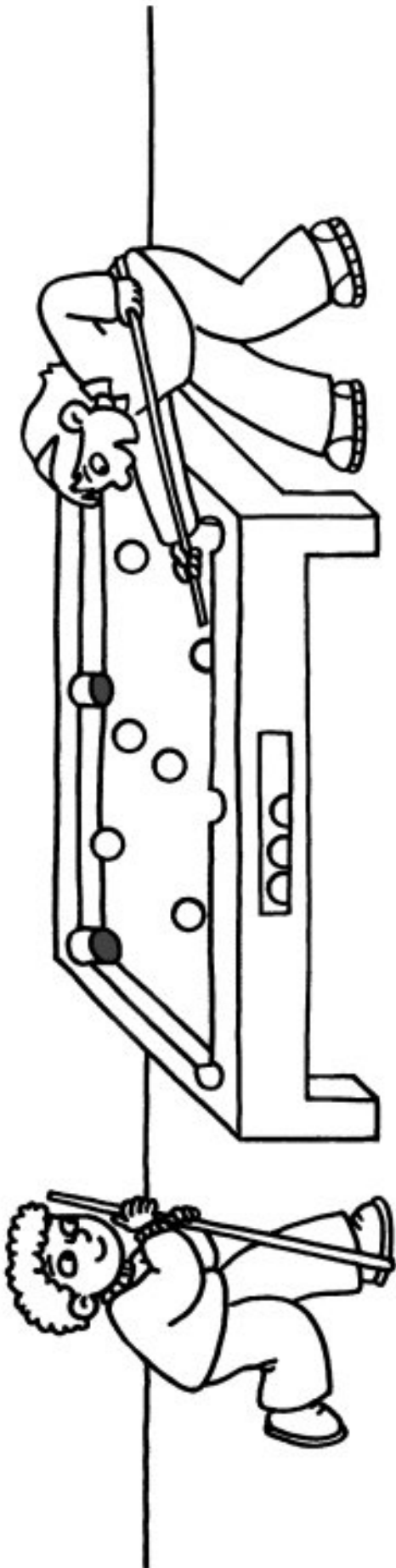

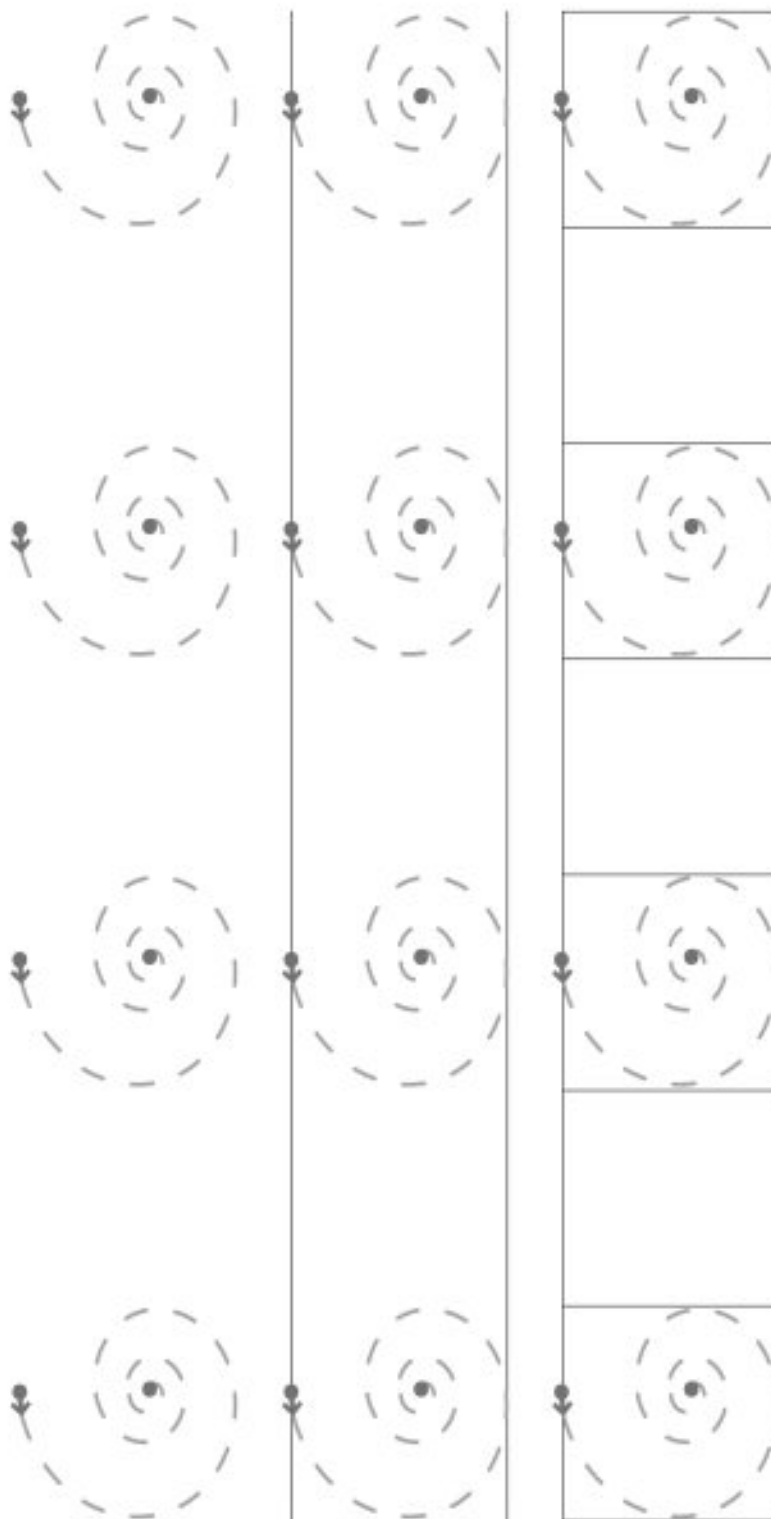

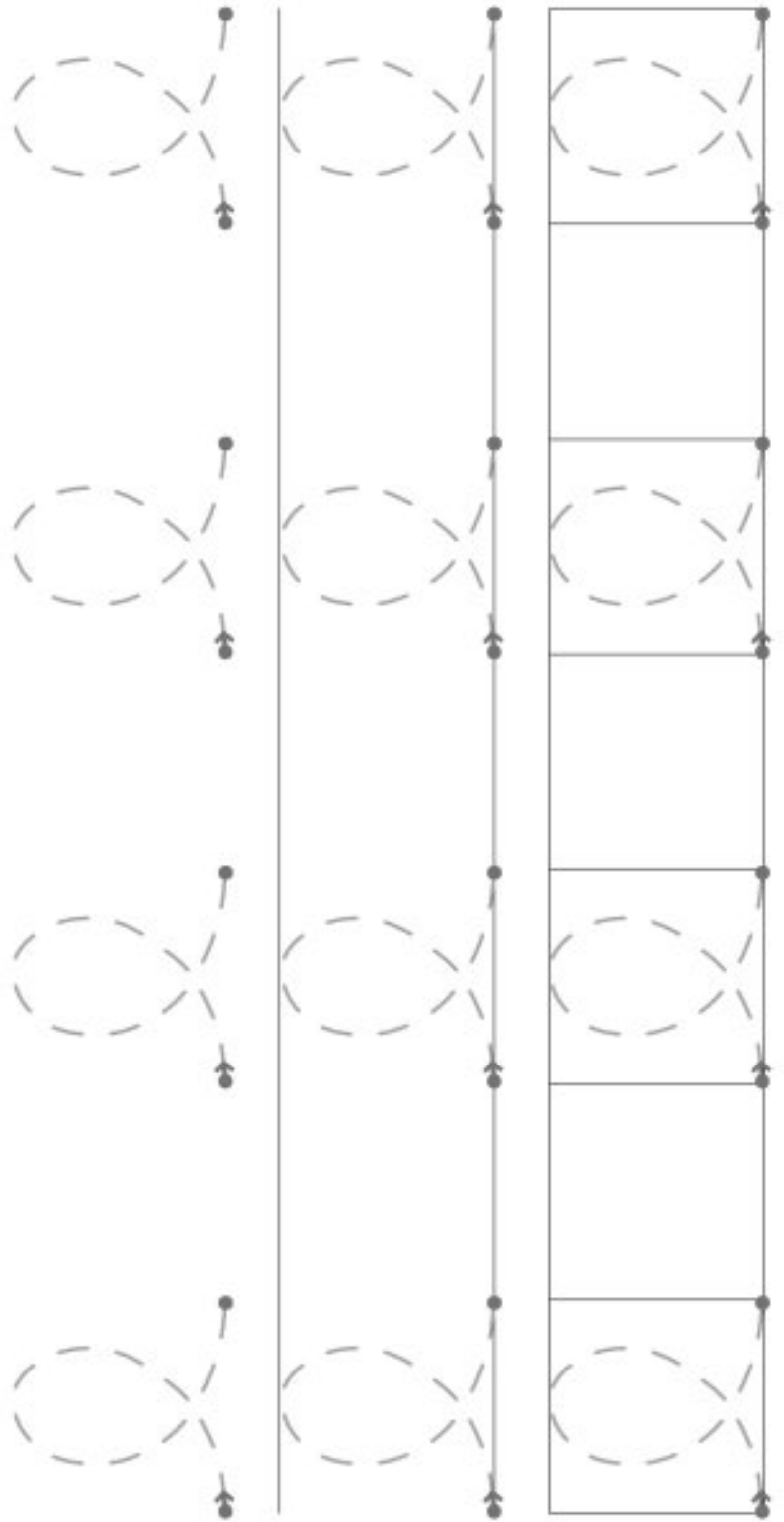
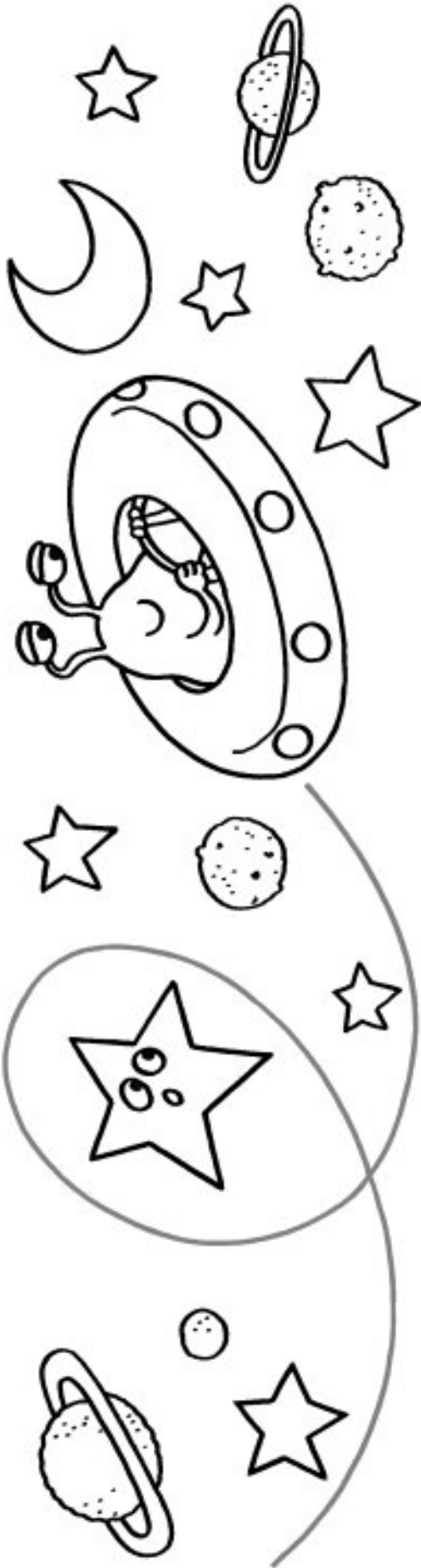

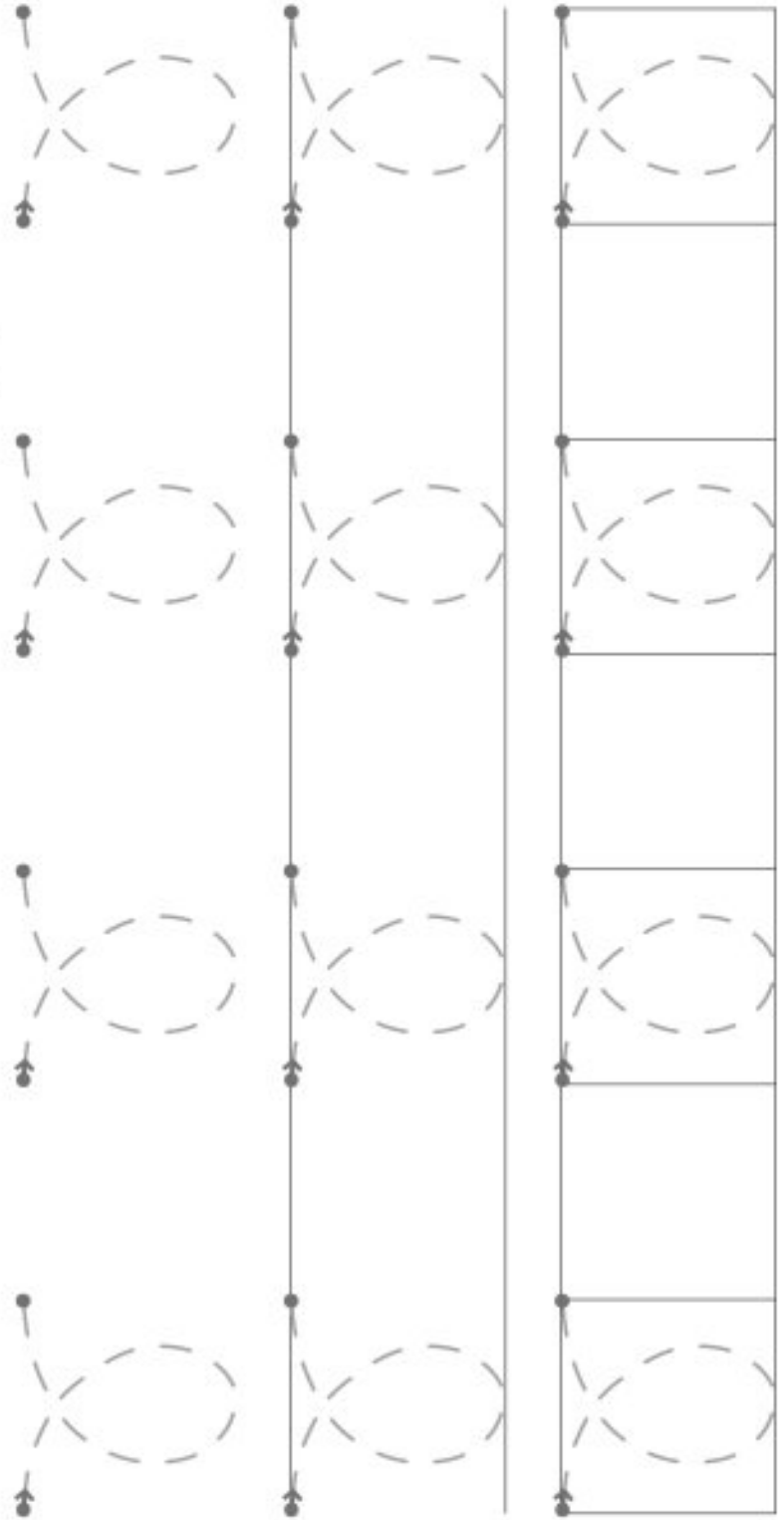
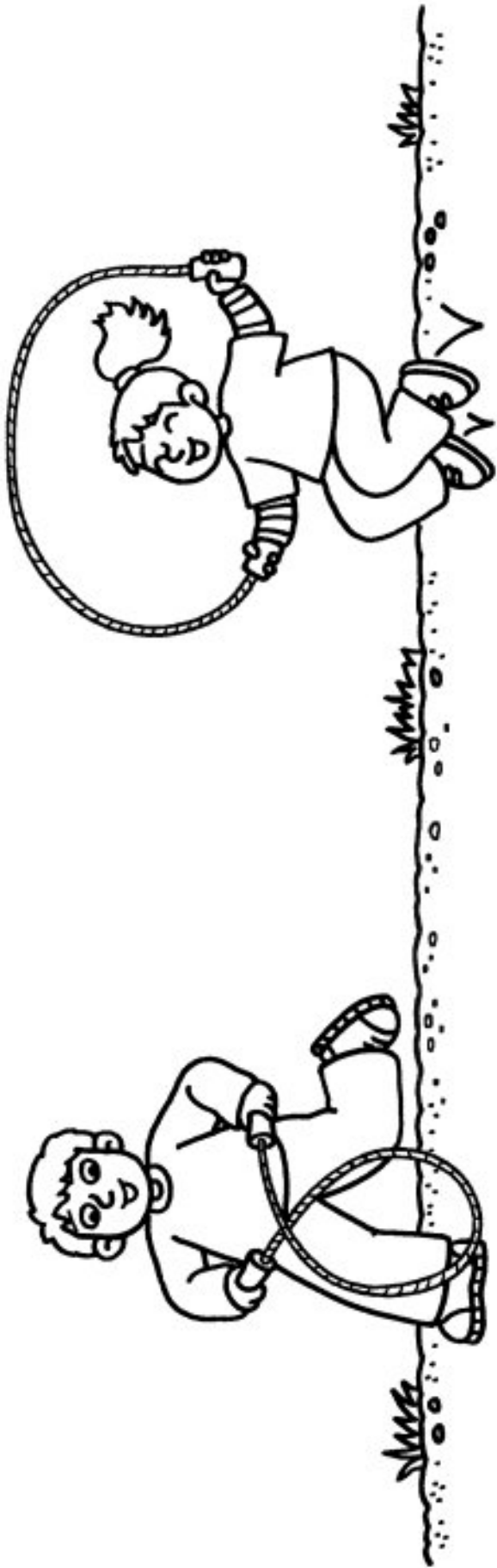

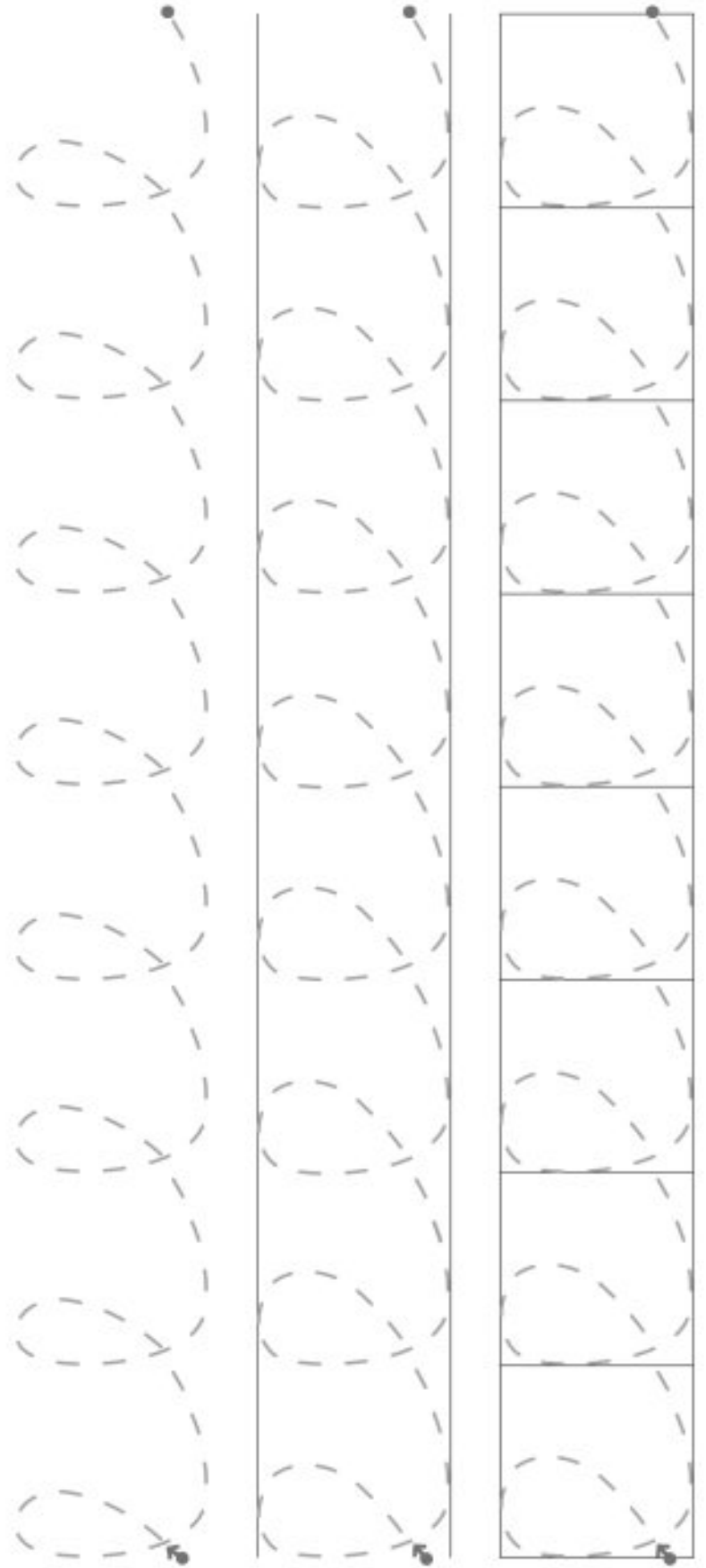
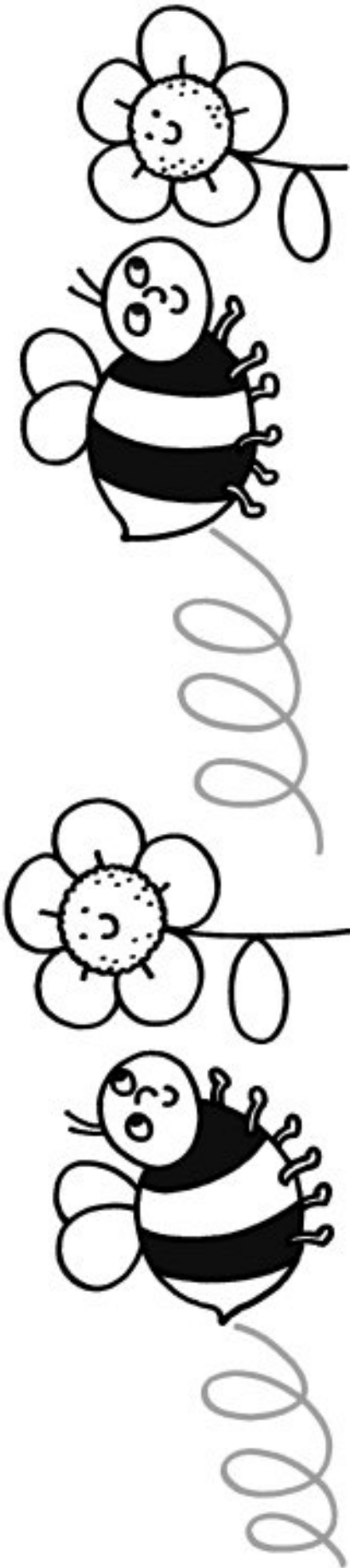

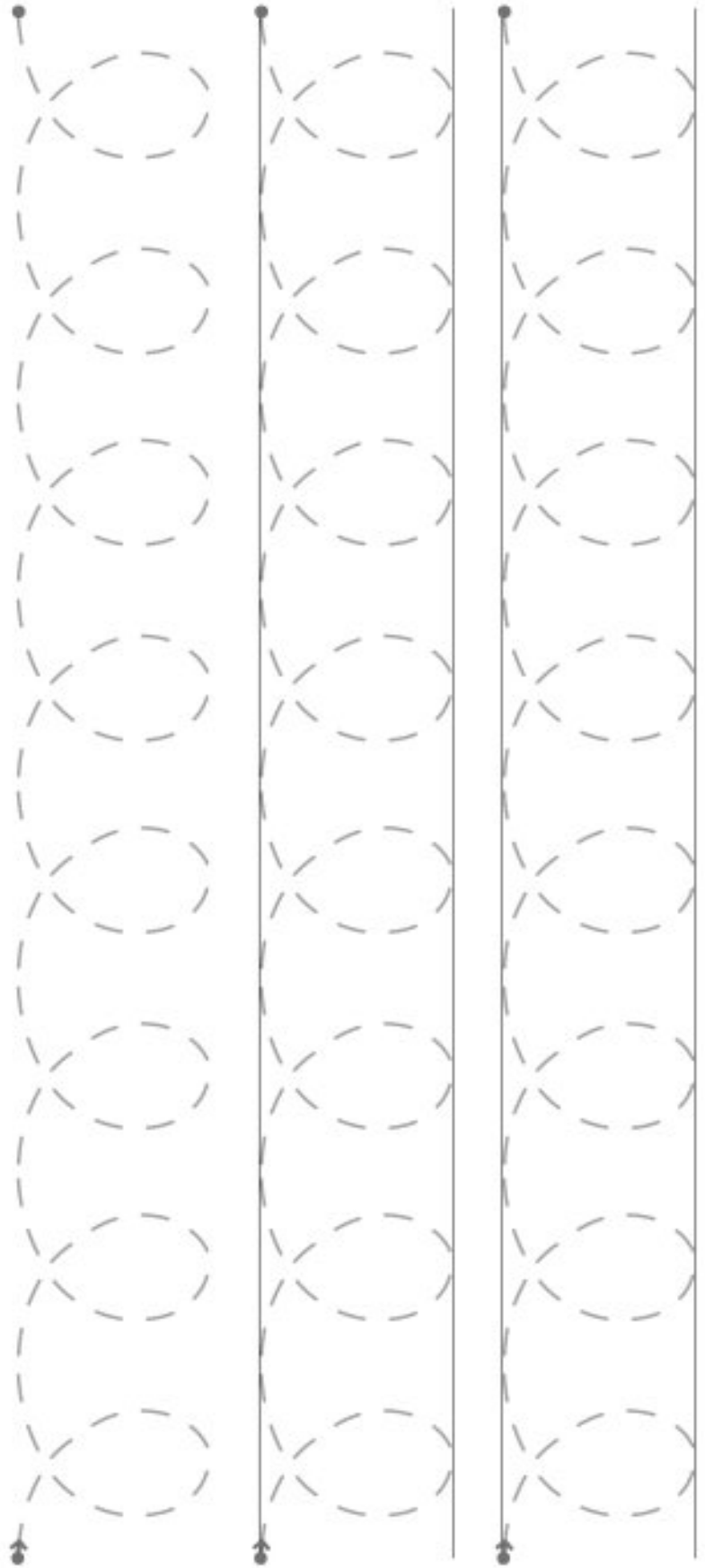
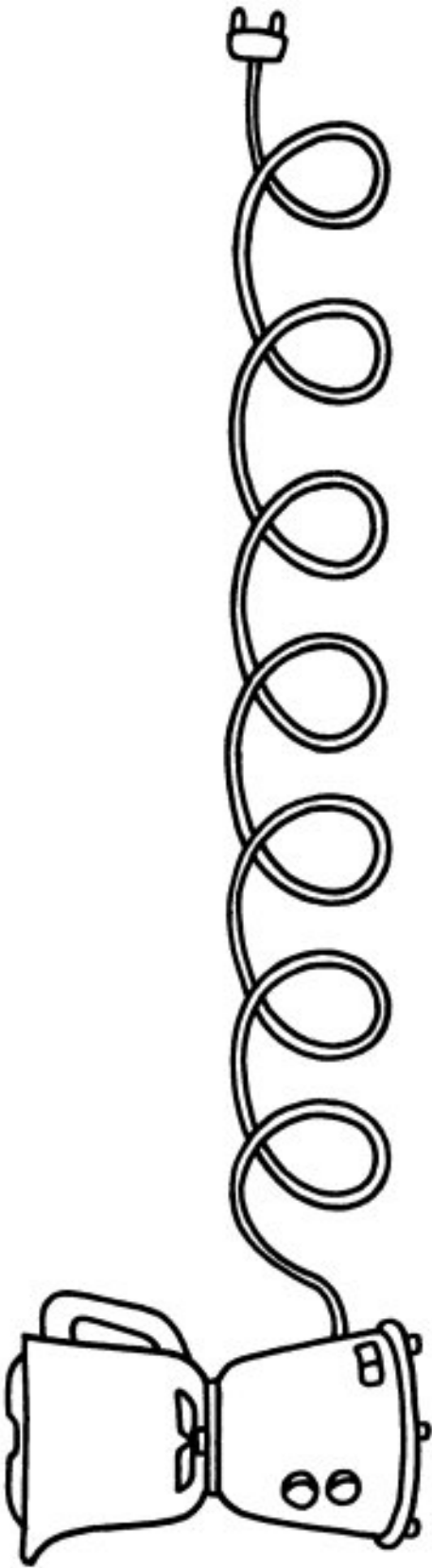

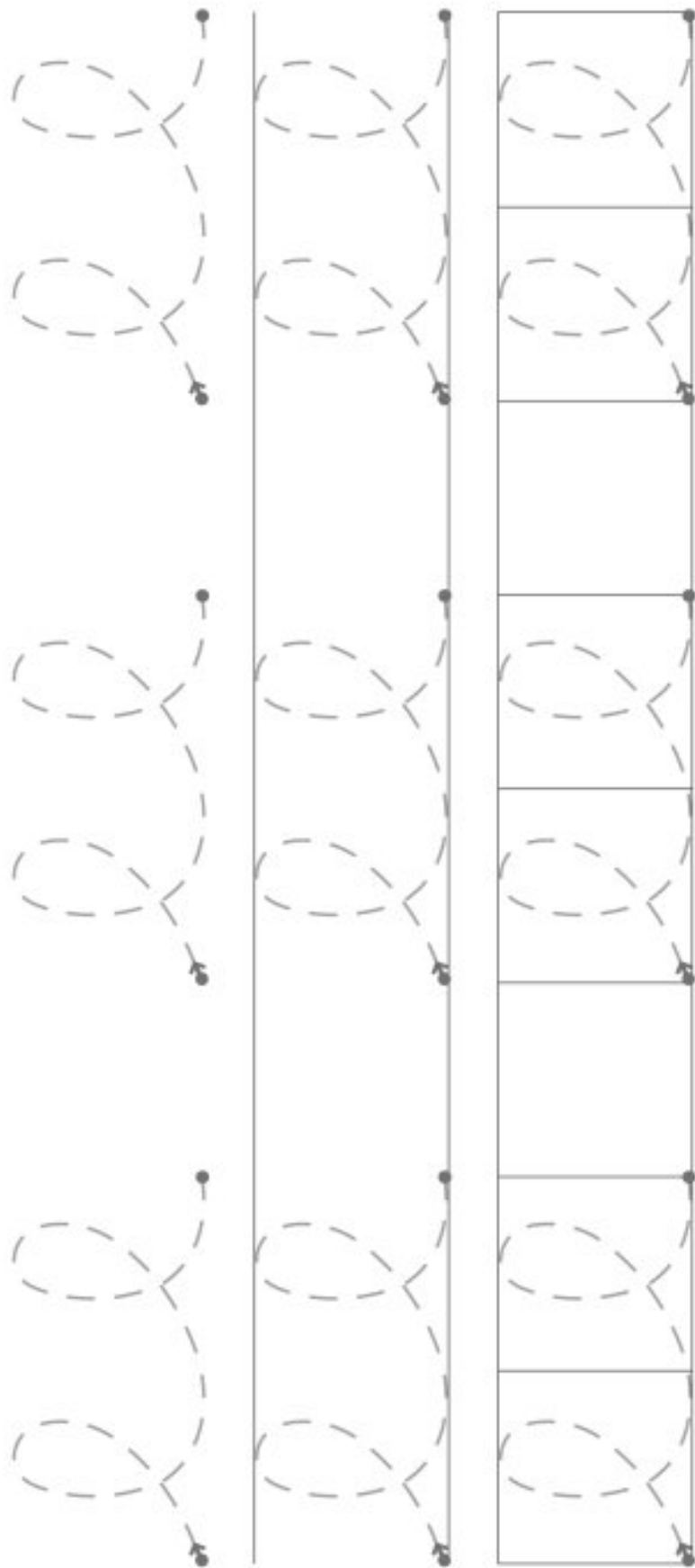

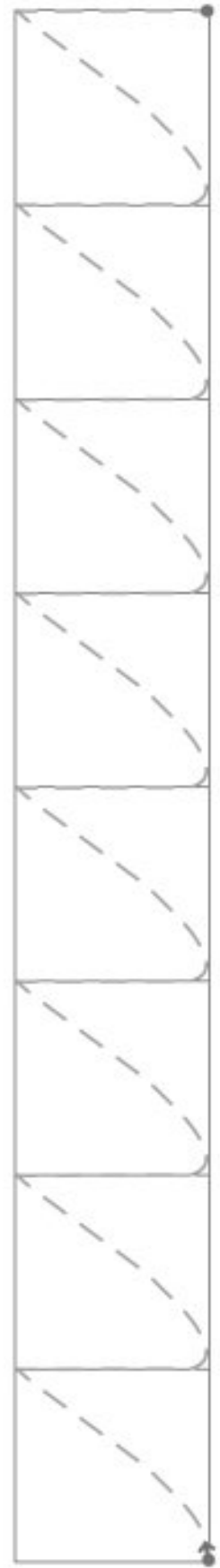
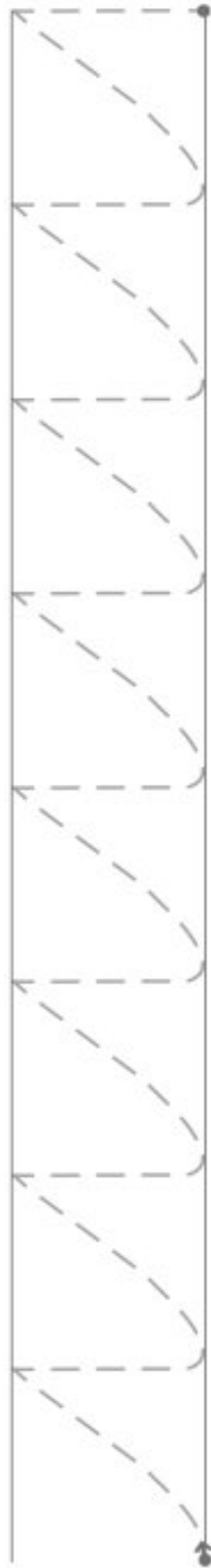

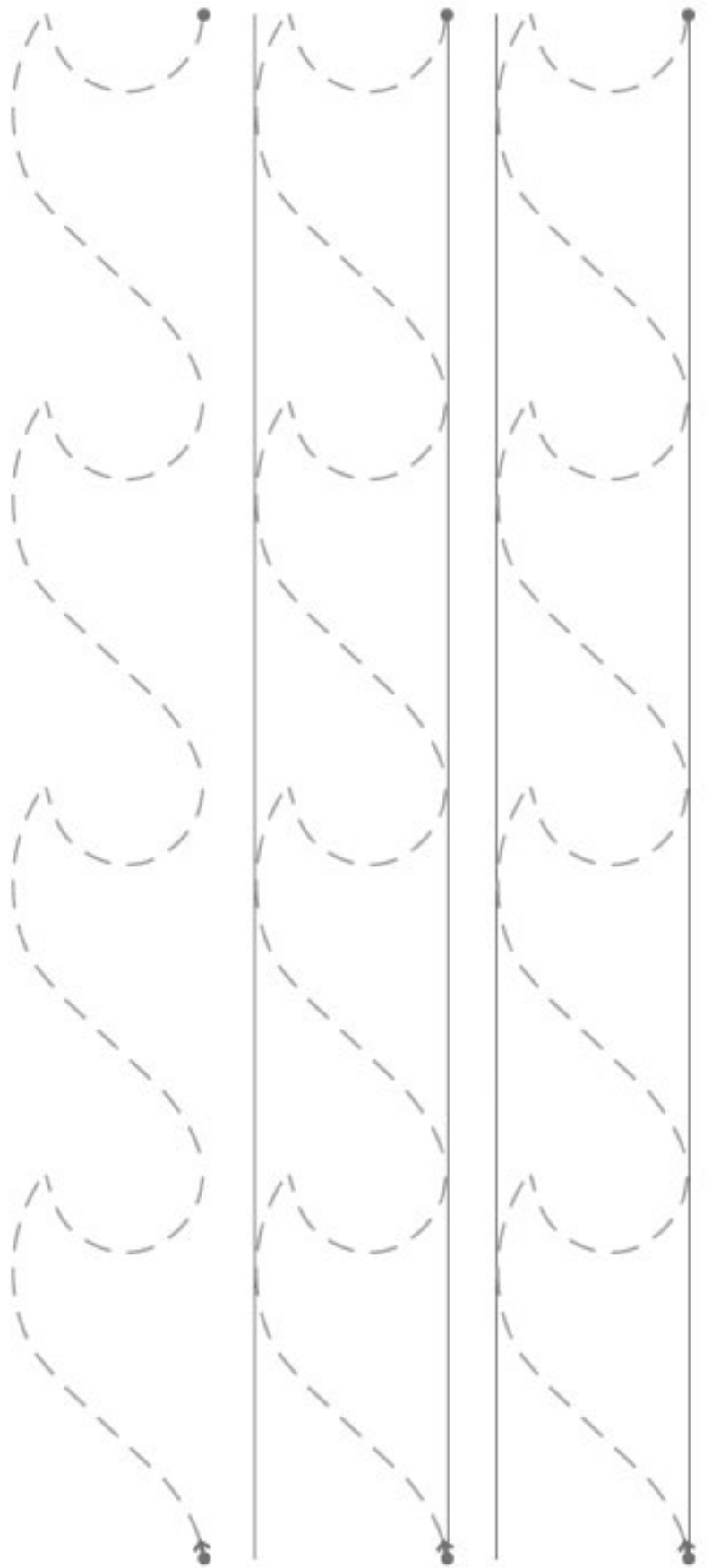
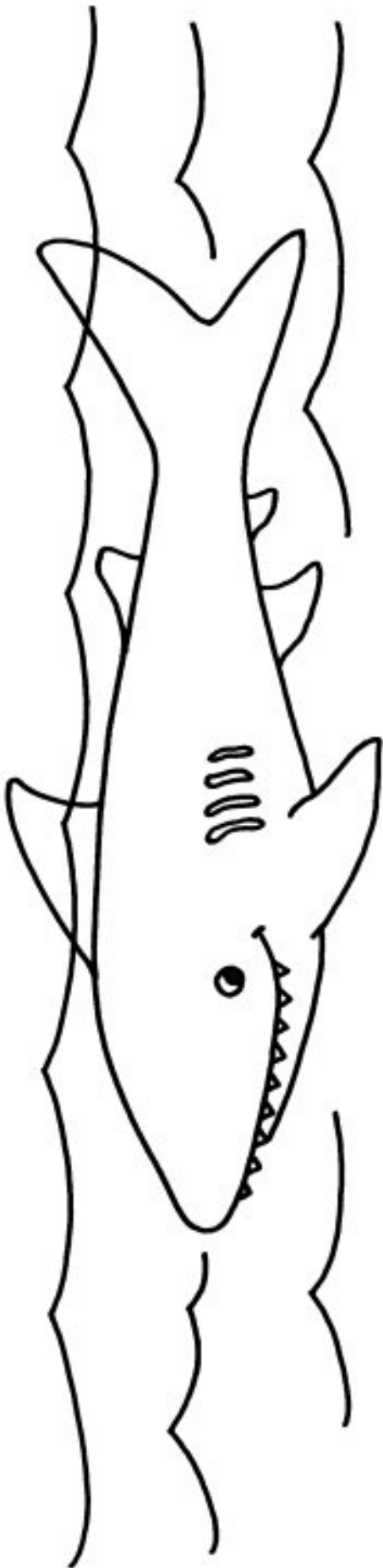



CÍRCULO

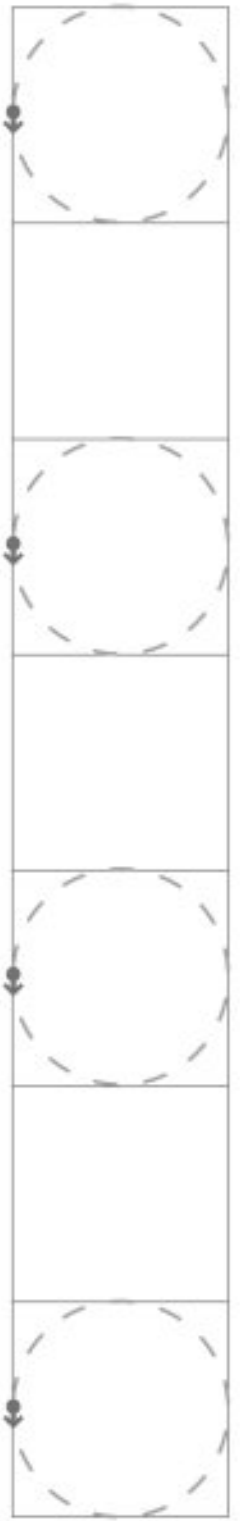
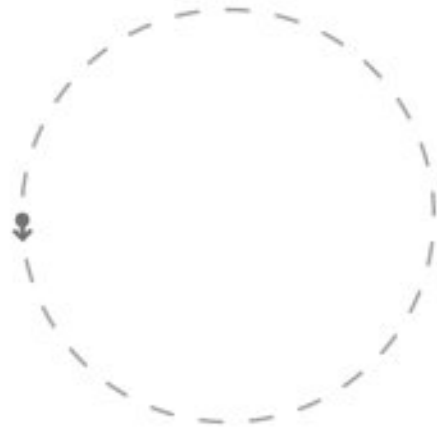
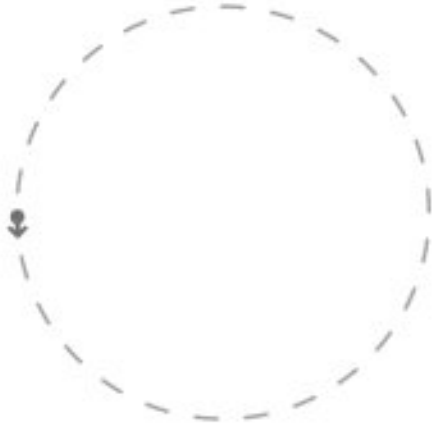

CUADRADO

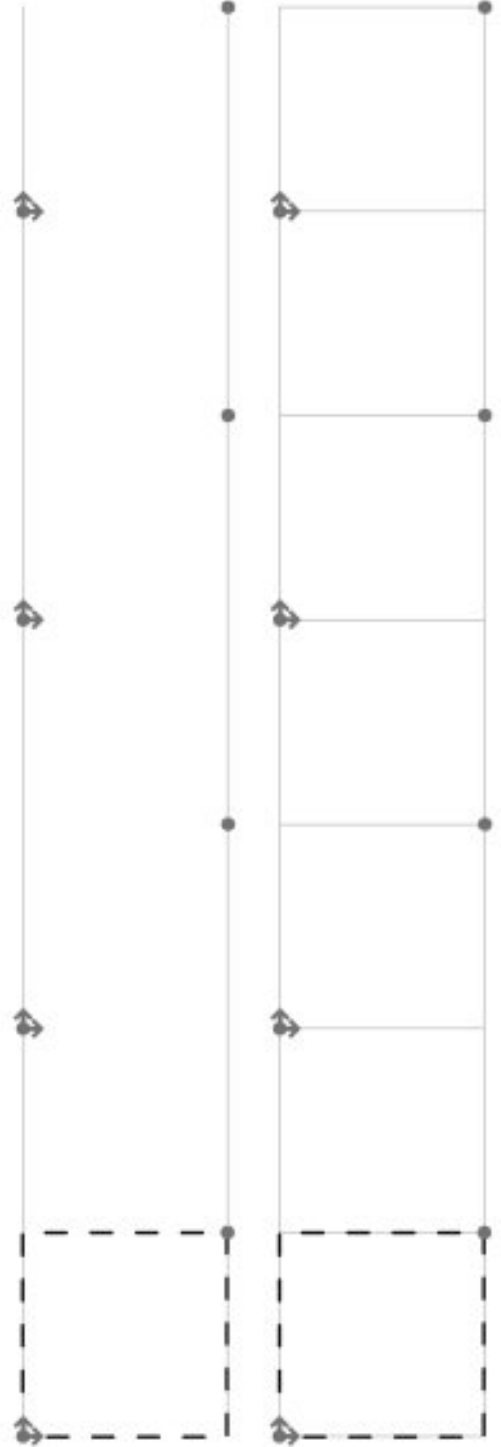

TRIÁNGULO

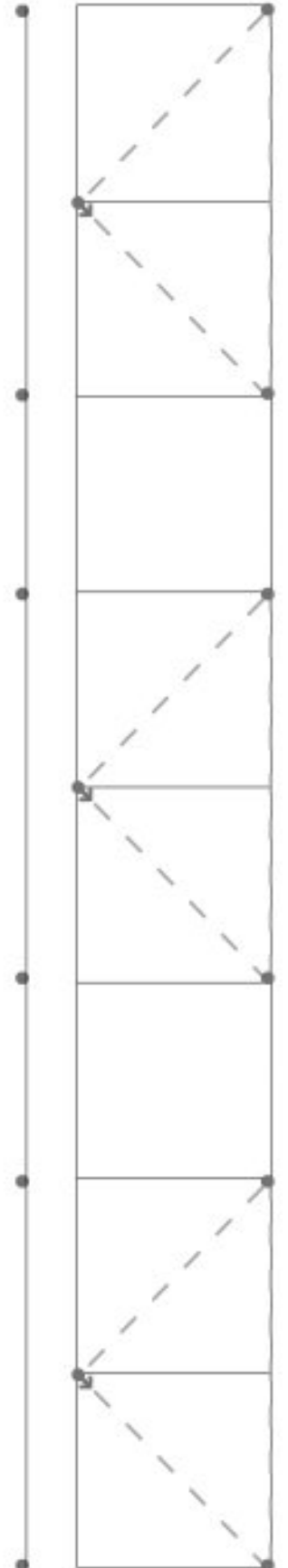
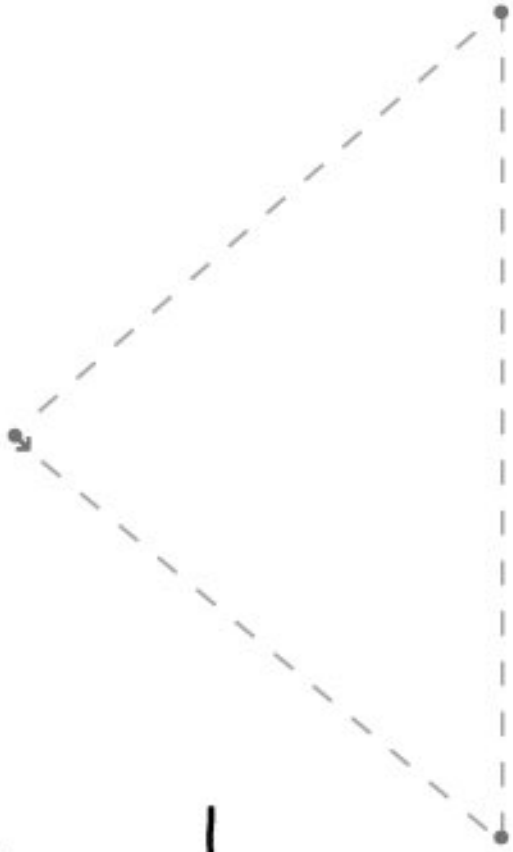
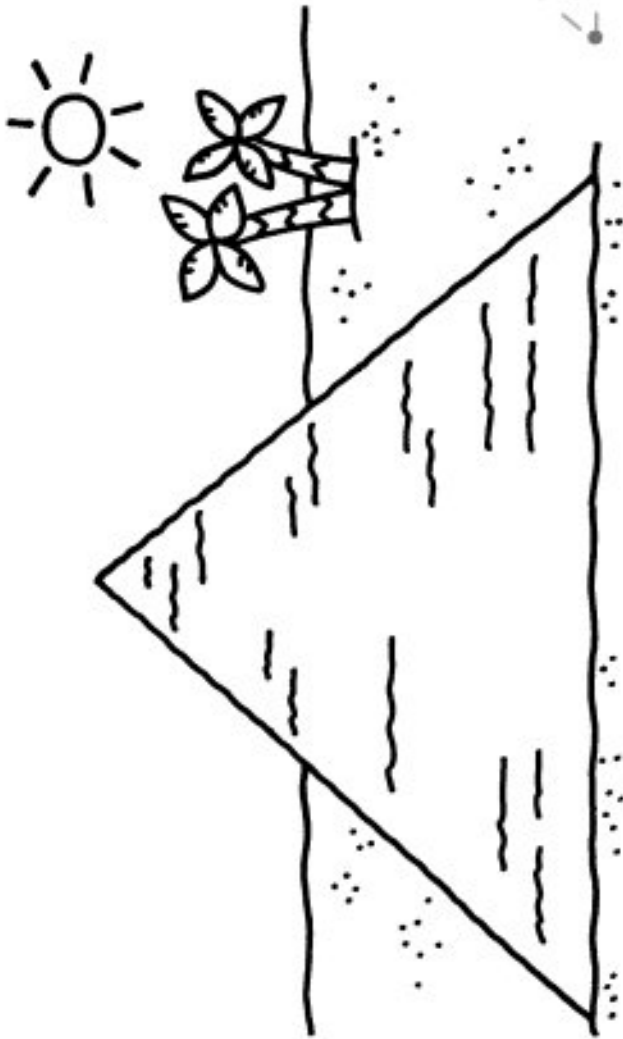

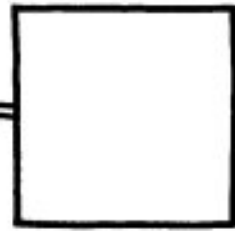
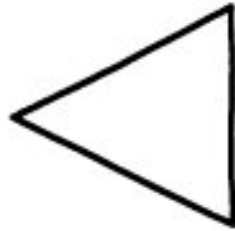
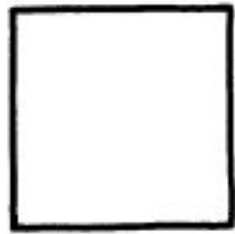
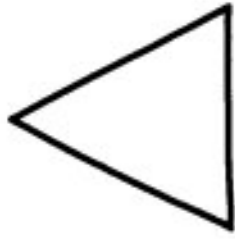

RECTÁNGULO

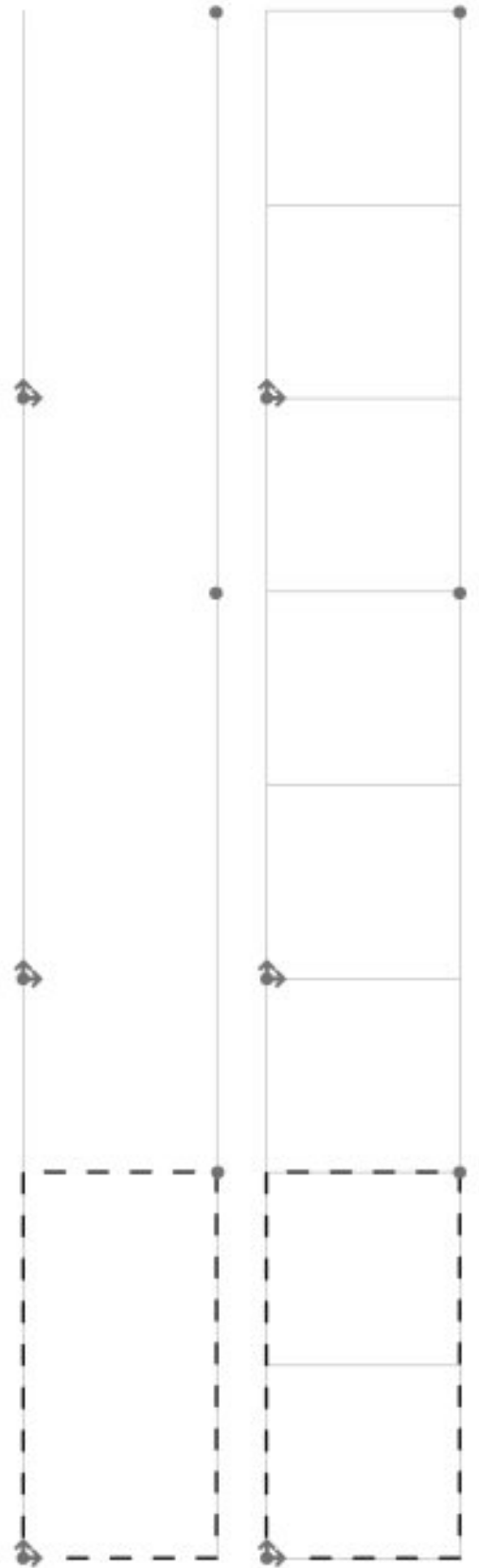
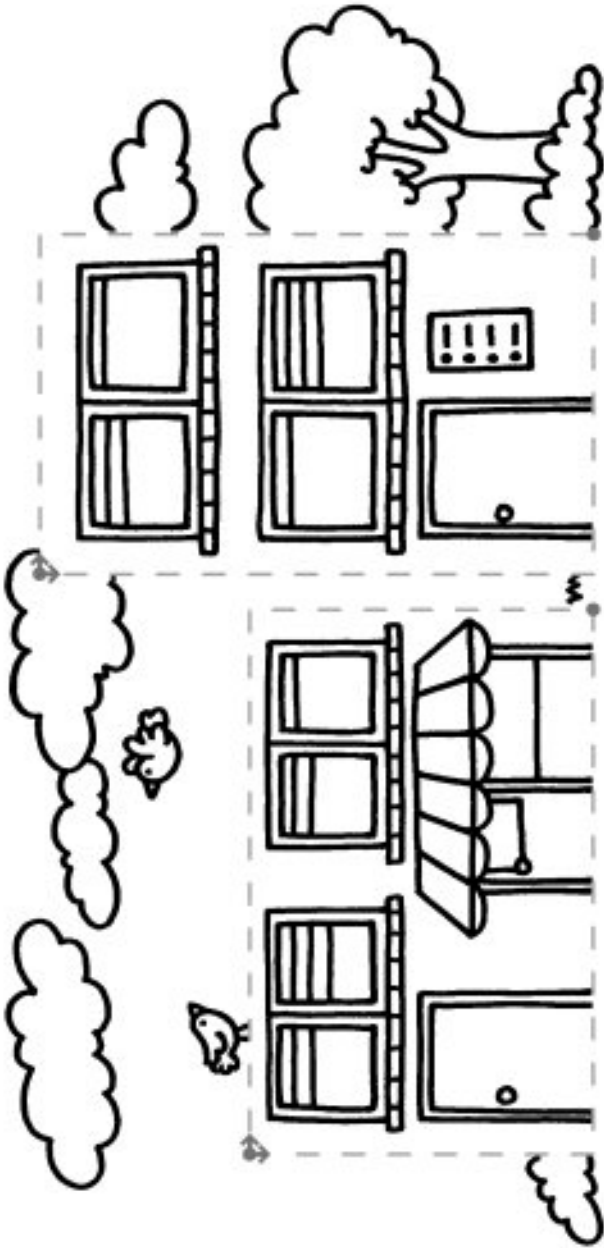

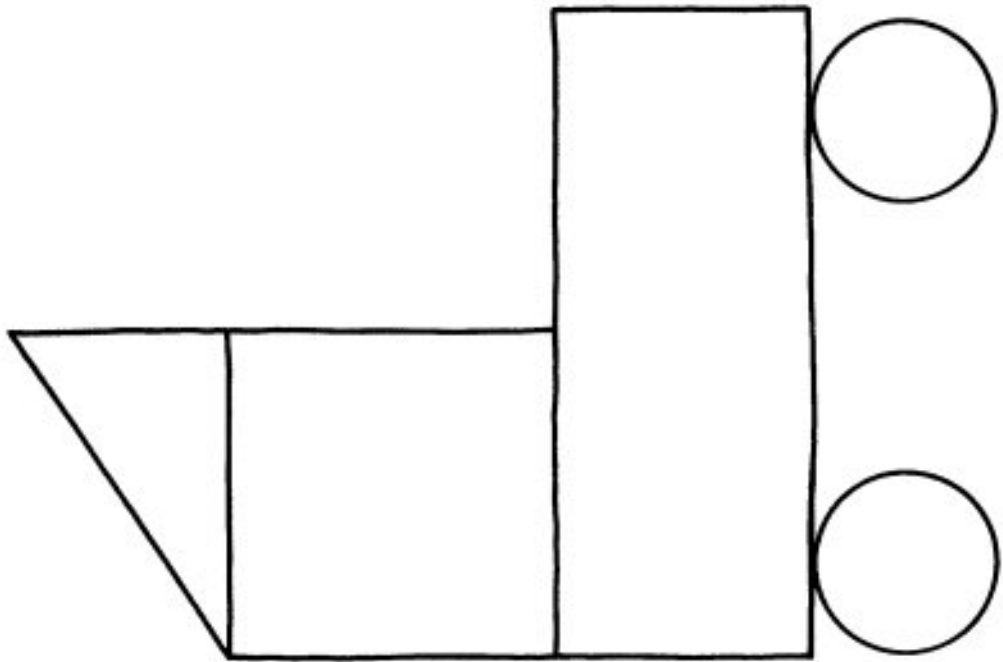

ÓVALO

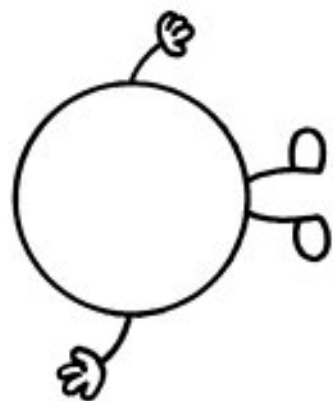
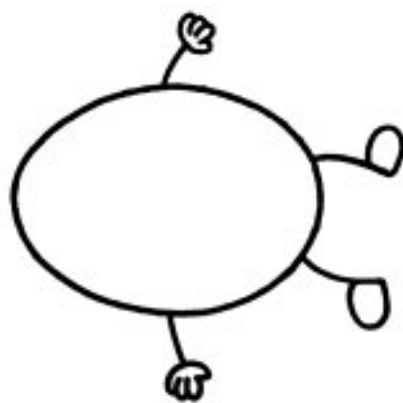
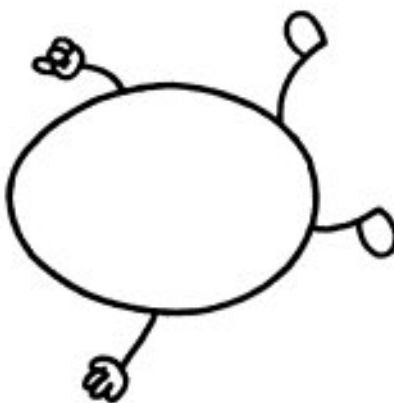

CÍRCULO

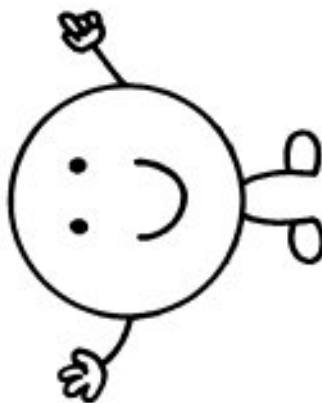
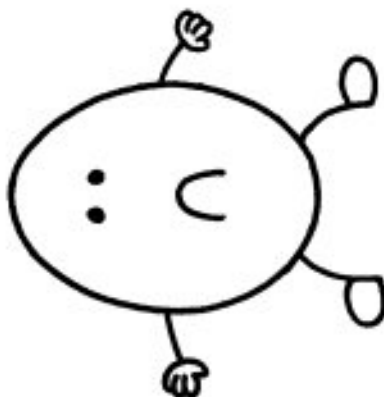

ESFERA

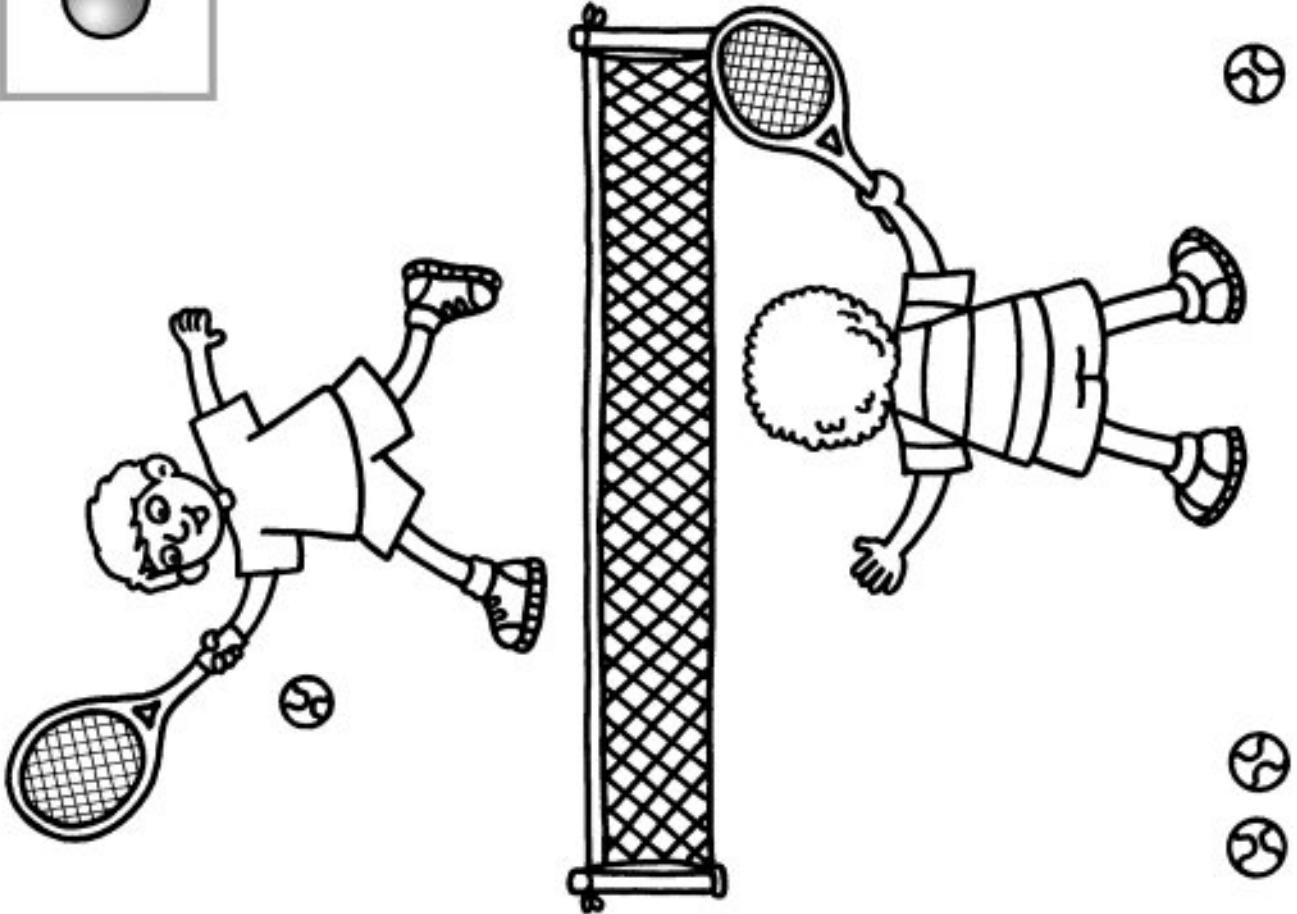



CUBO



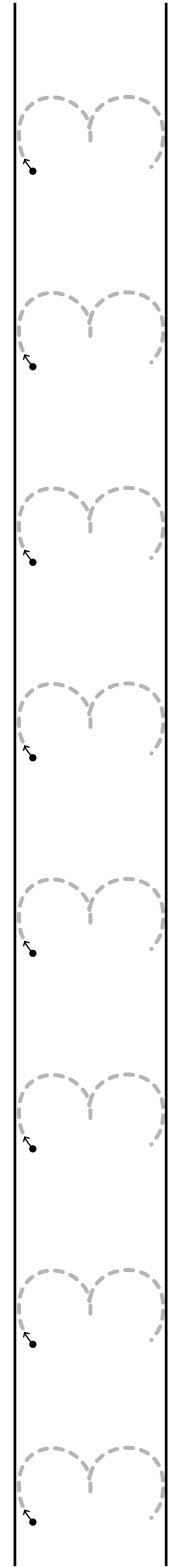
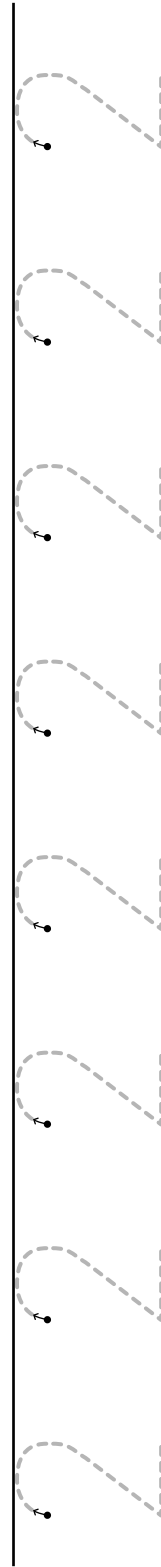
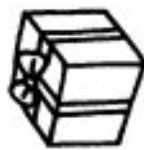
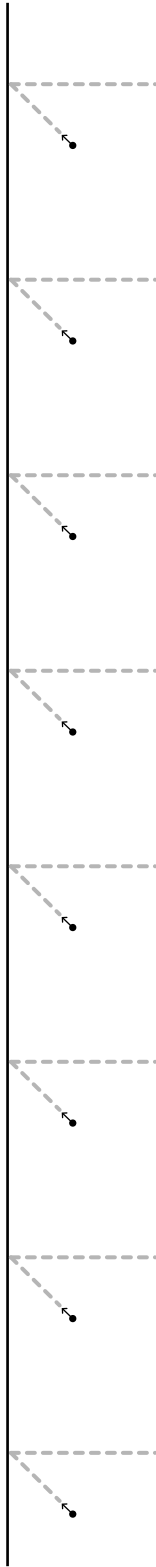

CUATRO

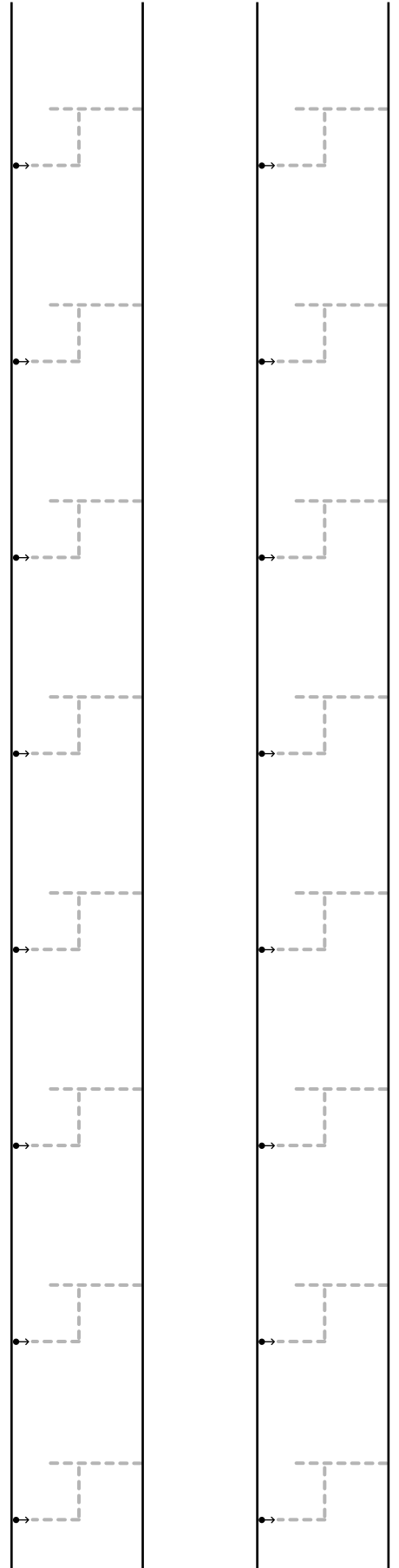
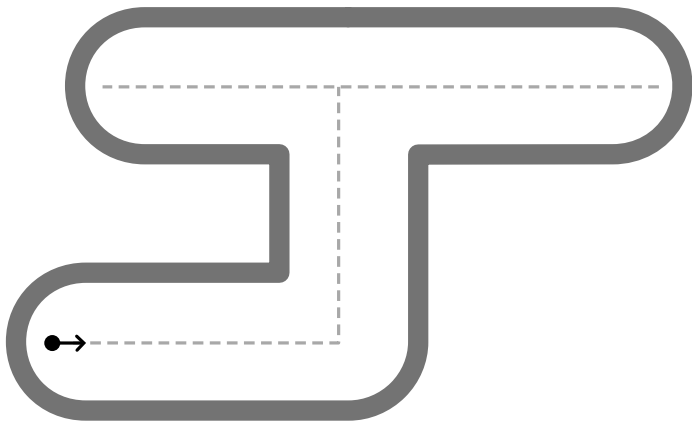
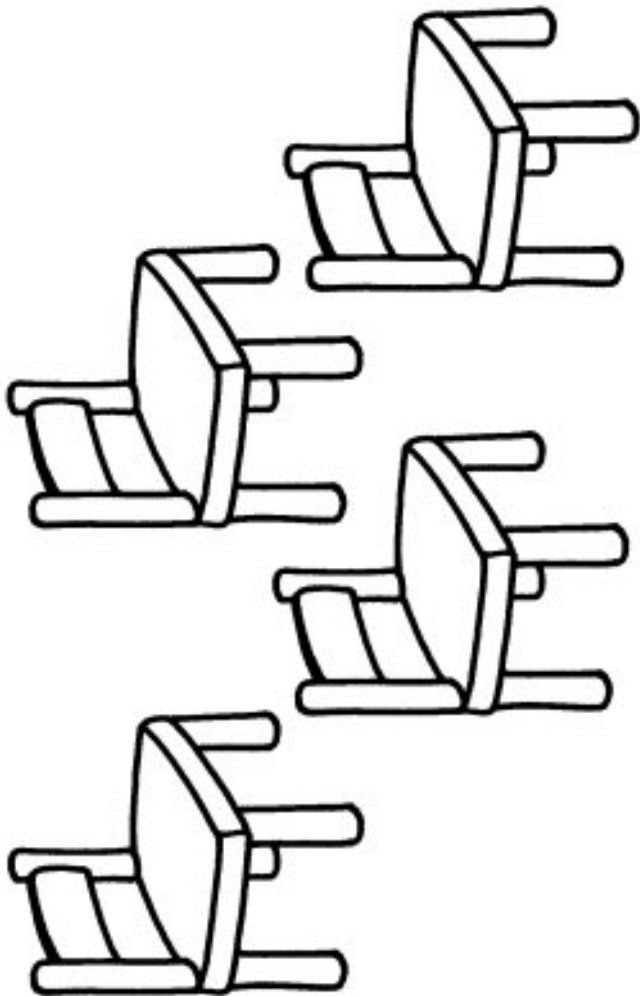

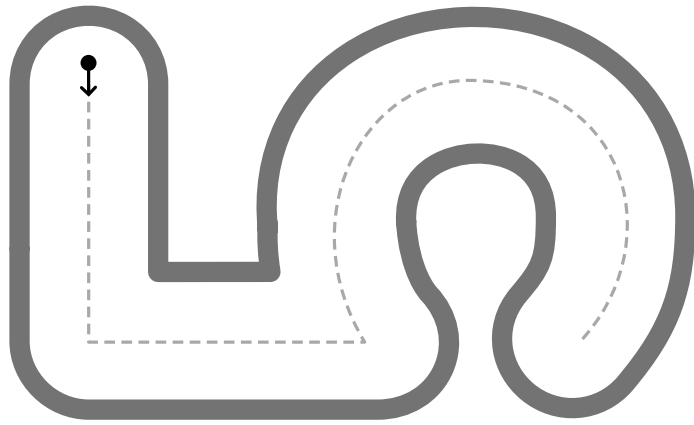

CINCO

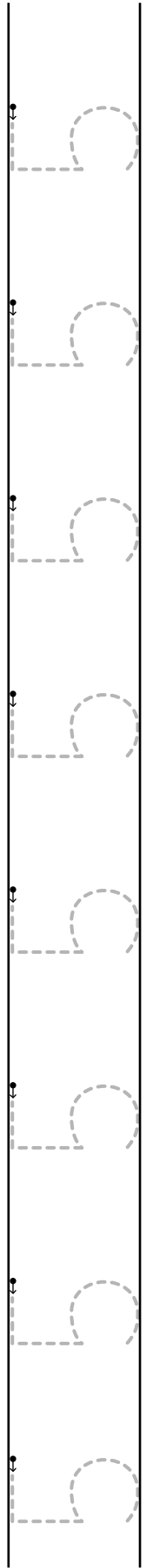
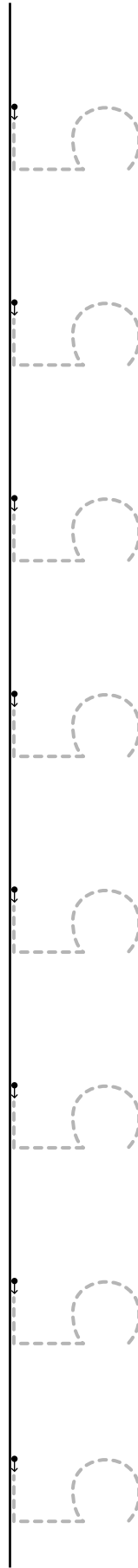
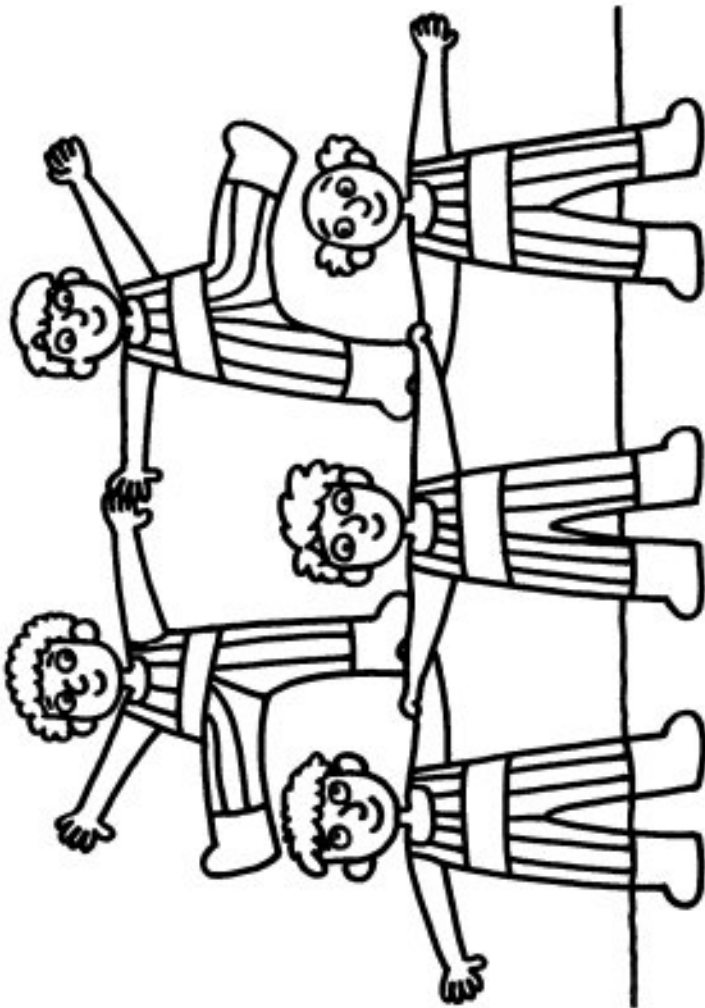

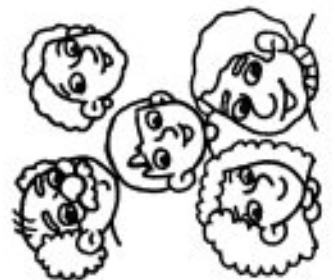
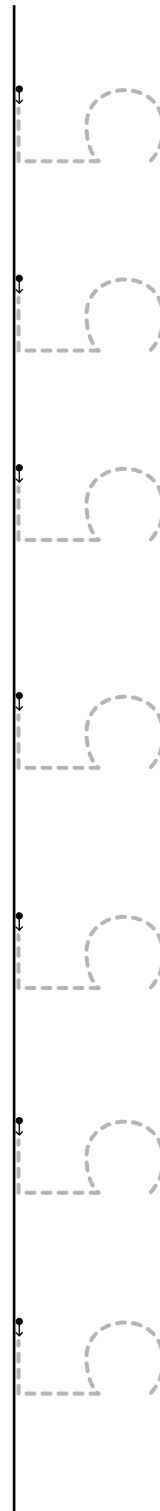
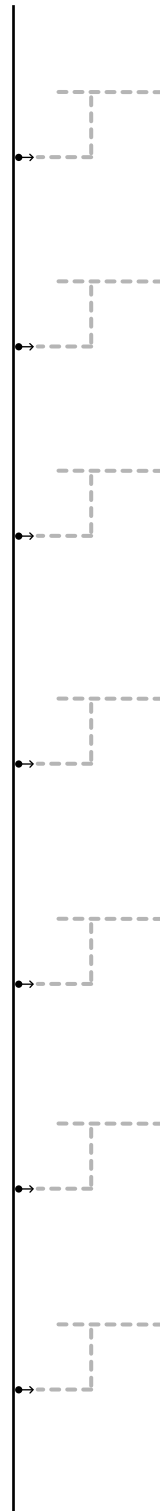
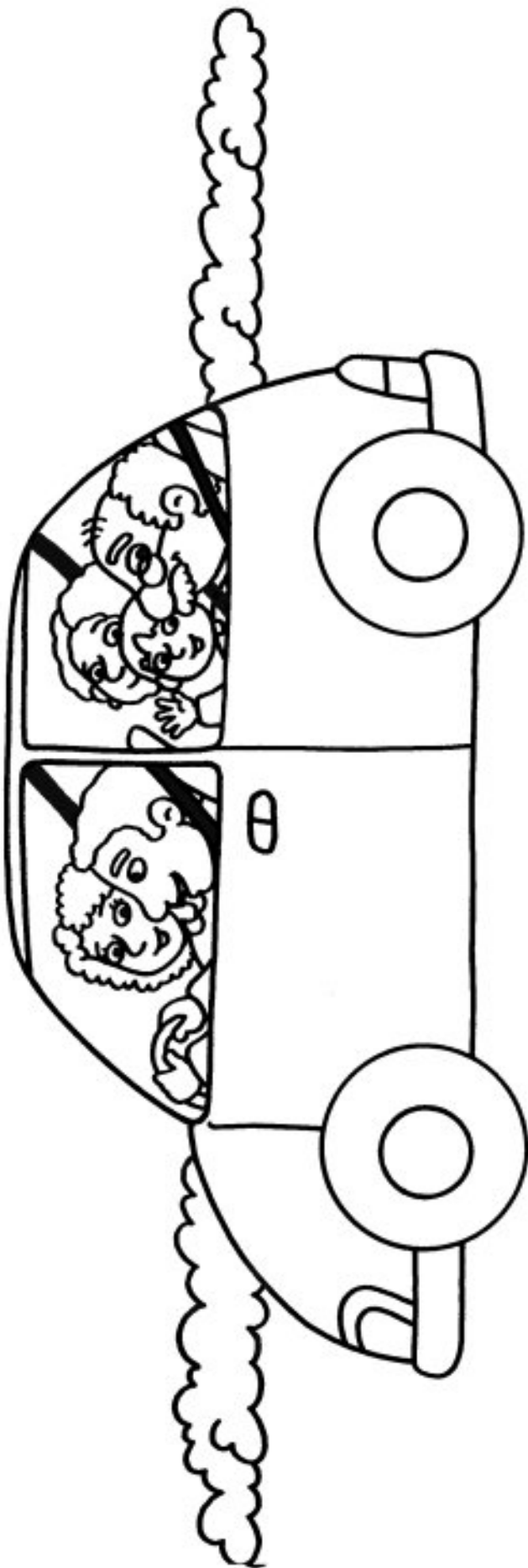

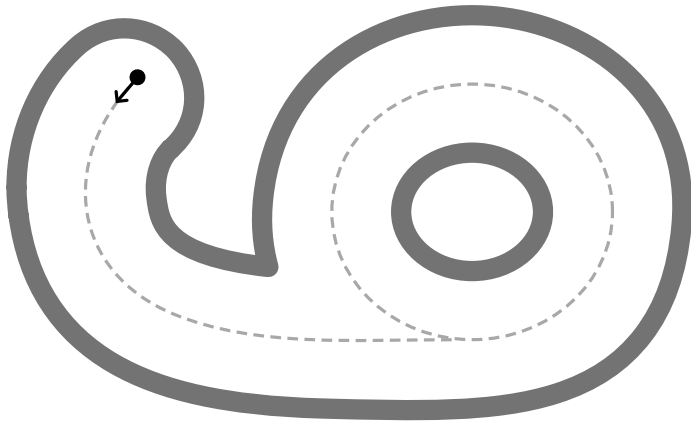

SEIS

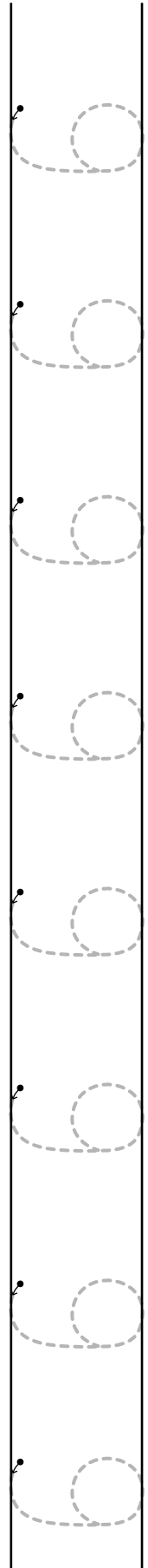
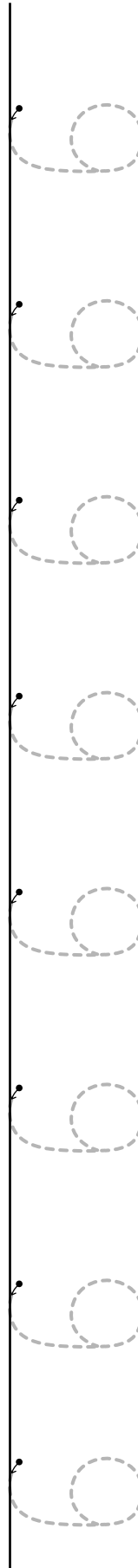
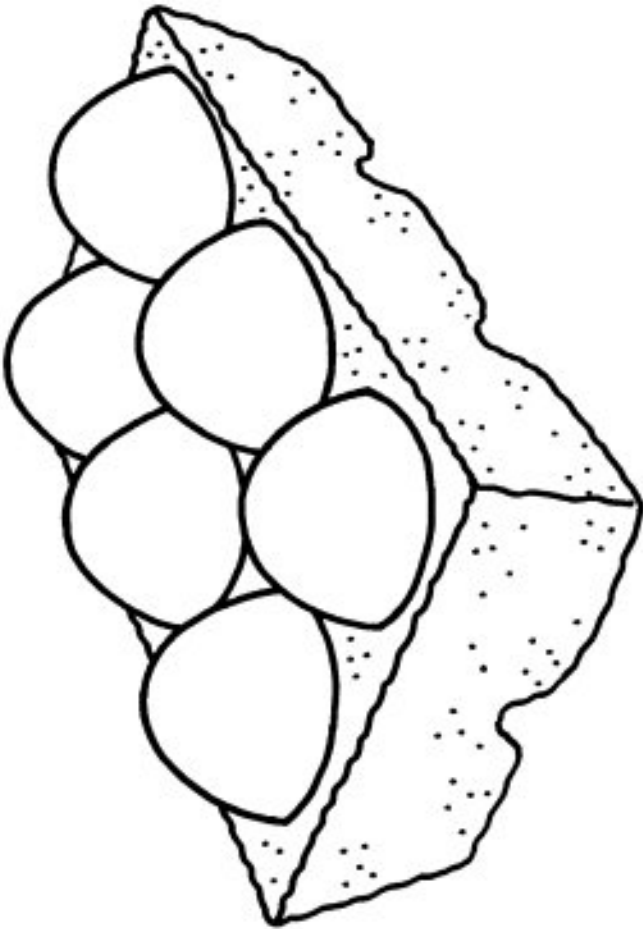

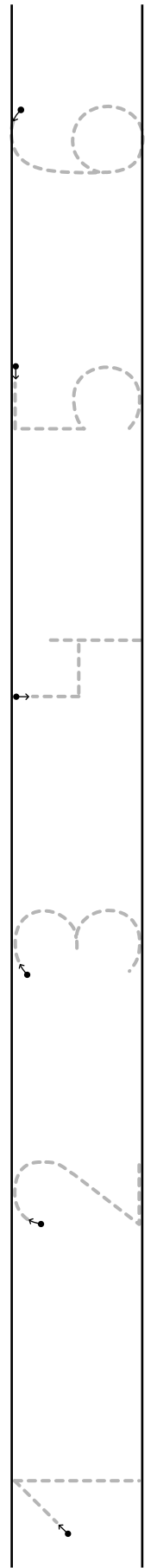
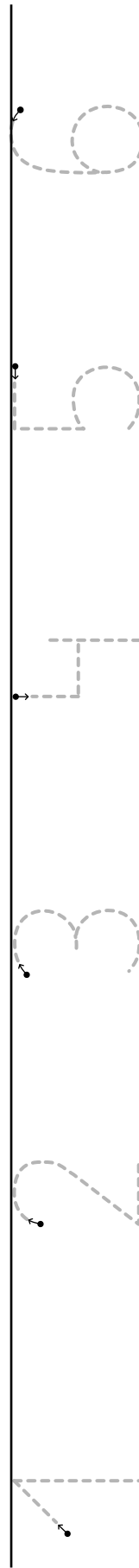
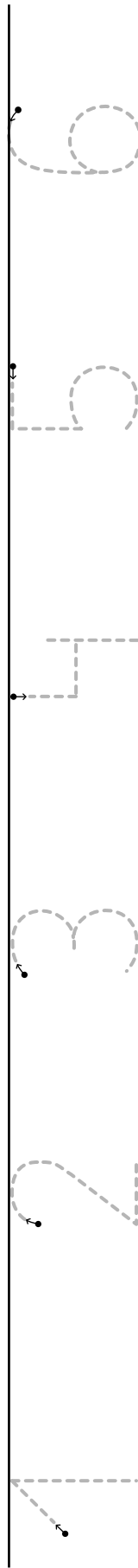
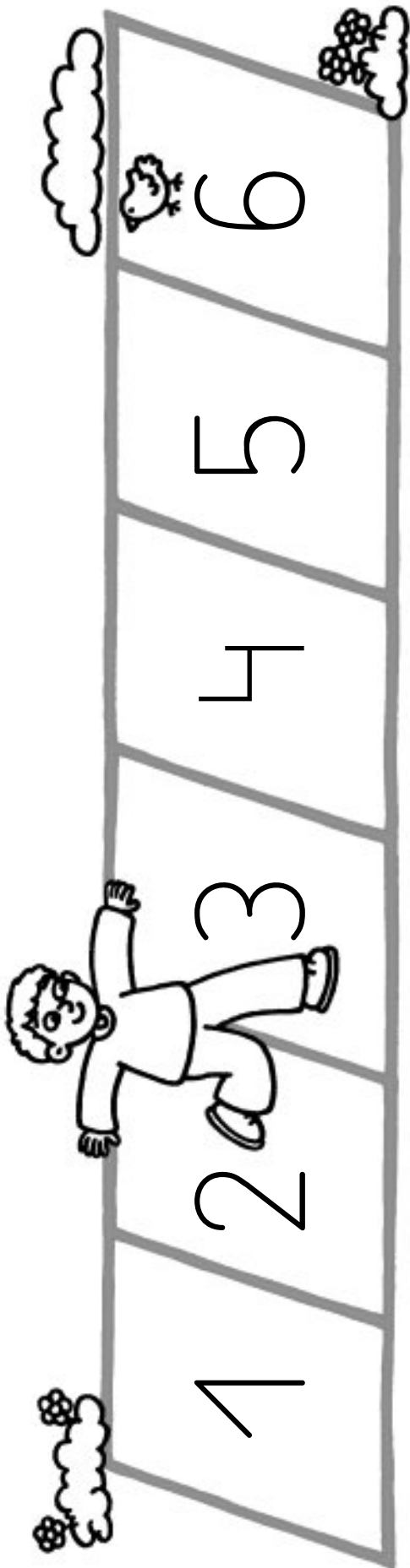

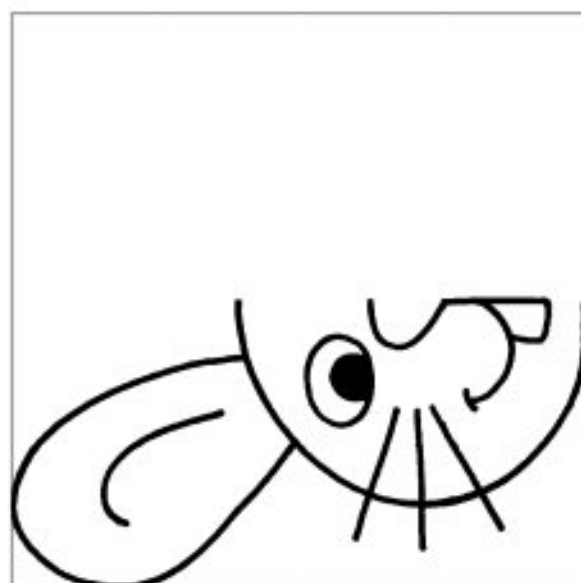
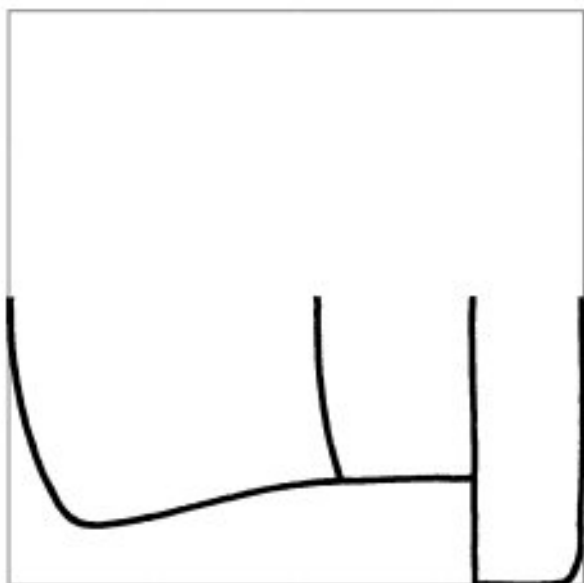

SIMETRÍA

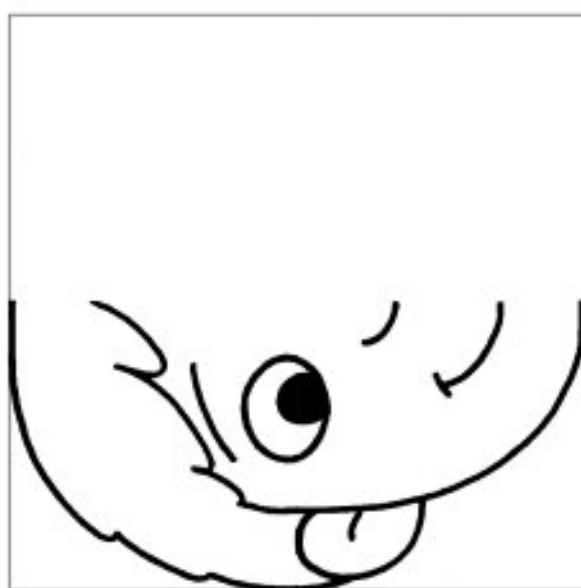
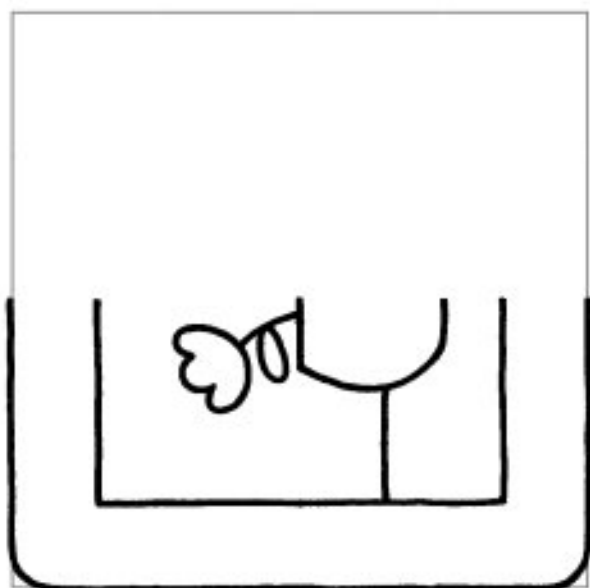

MUCHOS

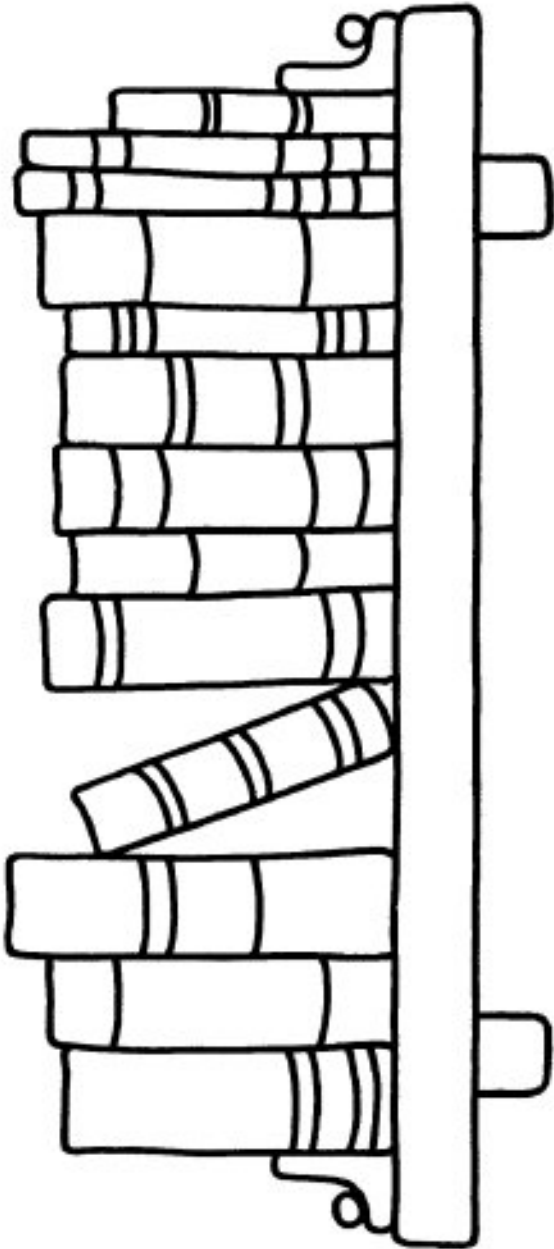

POCOS

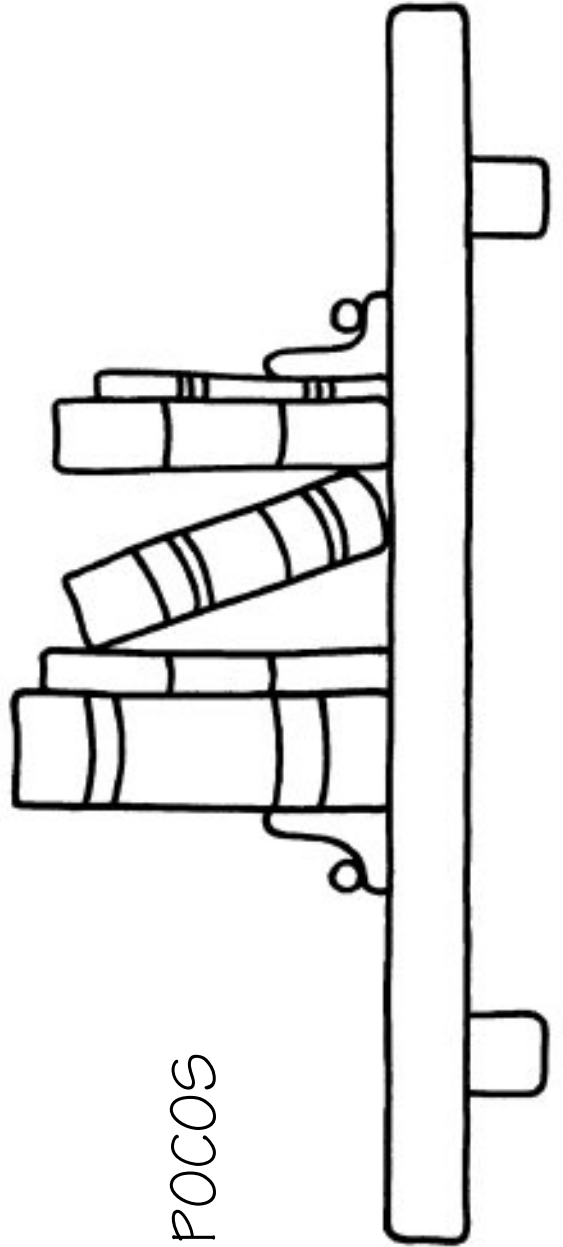

TODAS

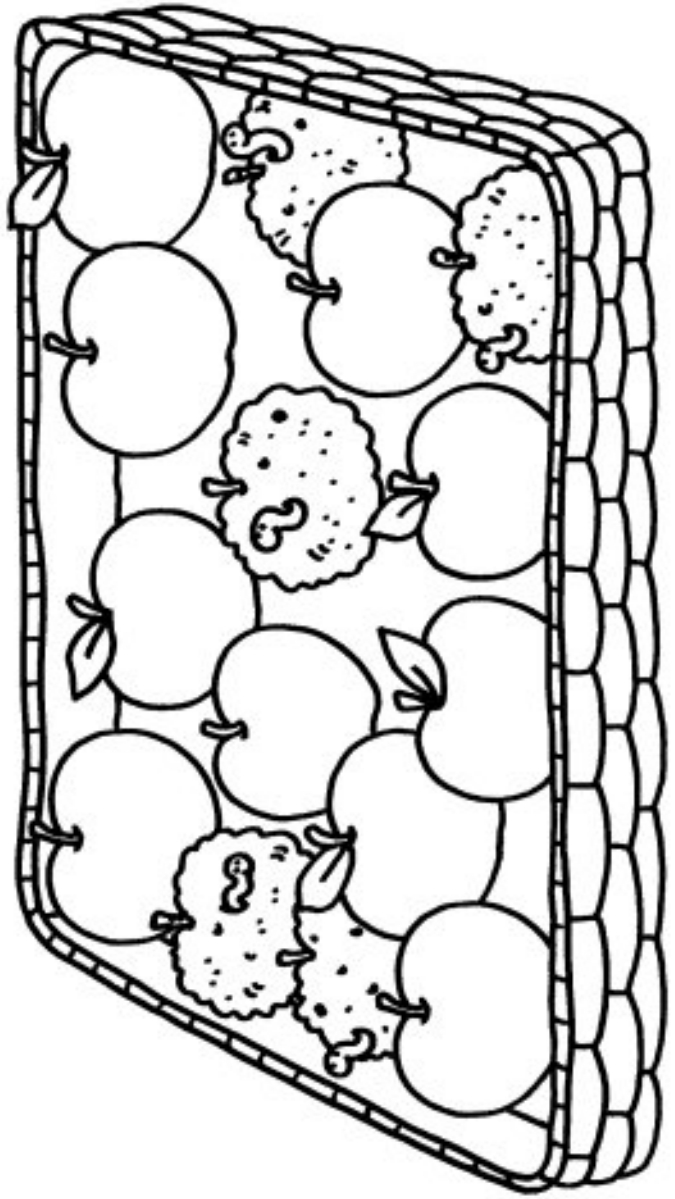
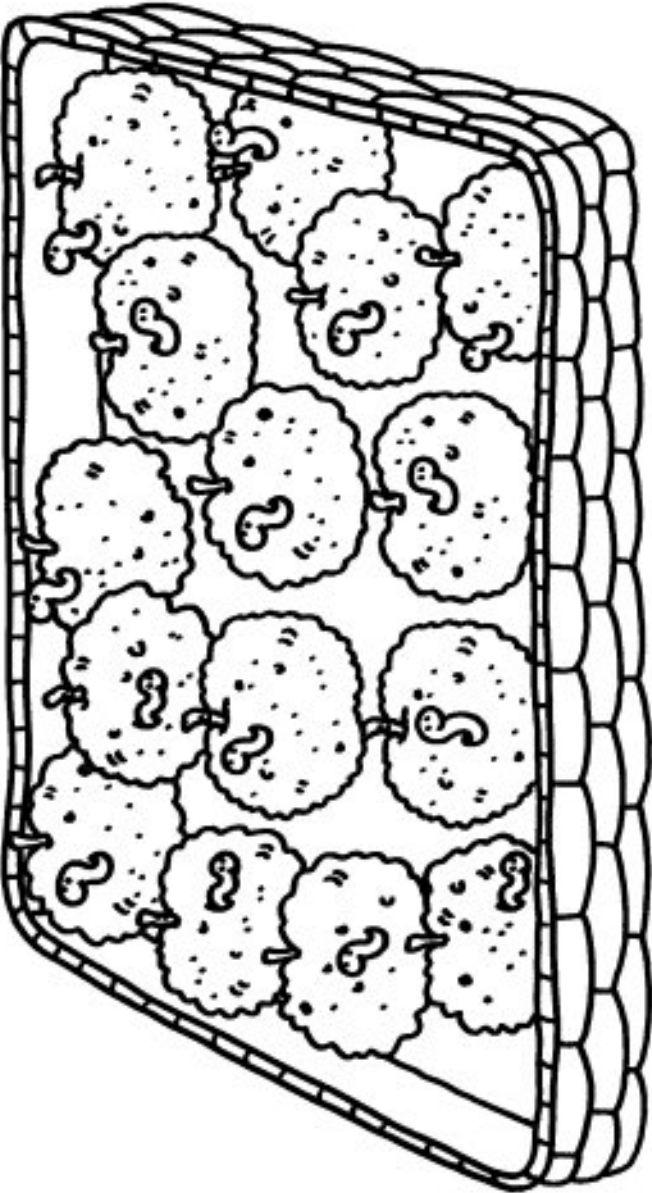

ALGUNAS

MITAD

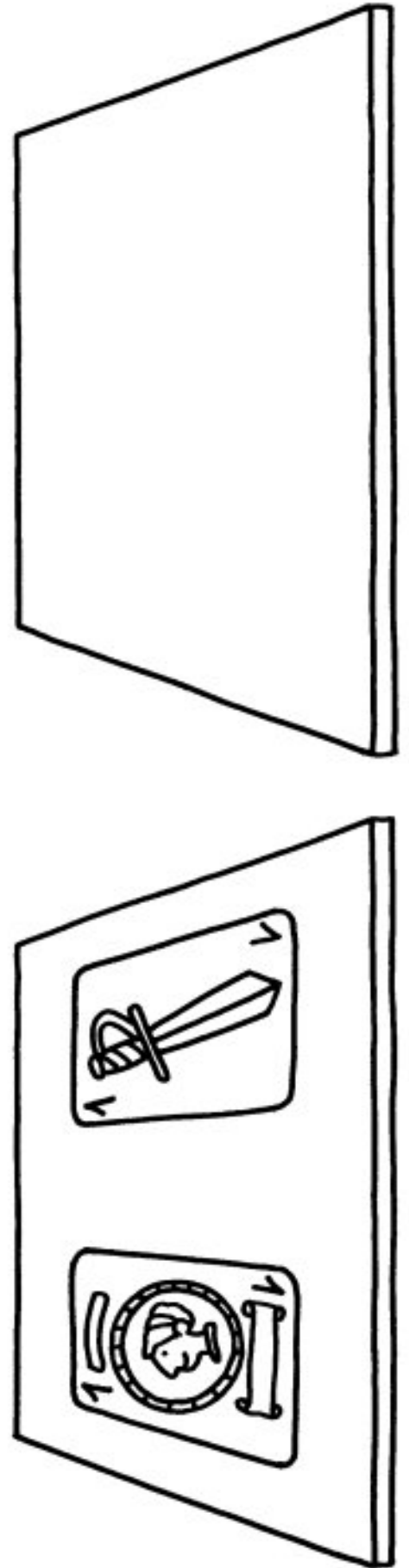

NINGUNA

ALGUNAS

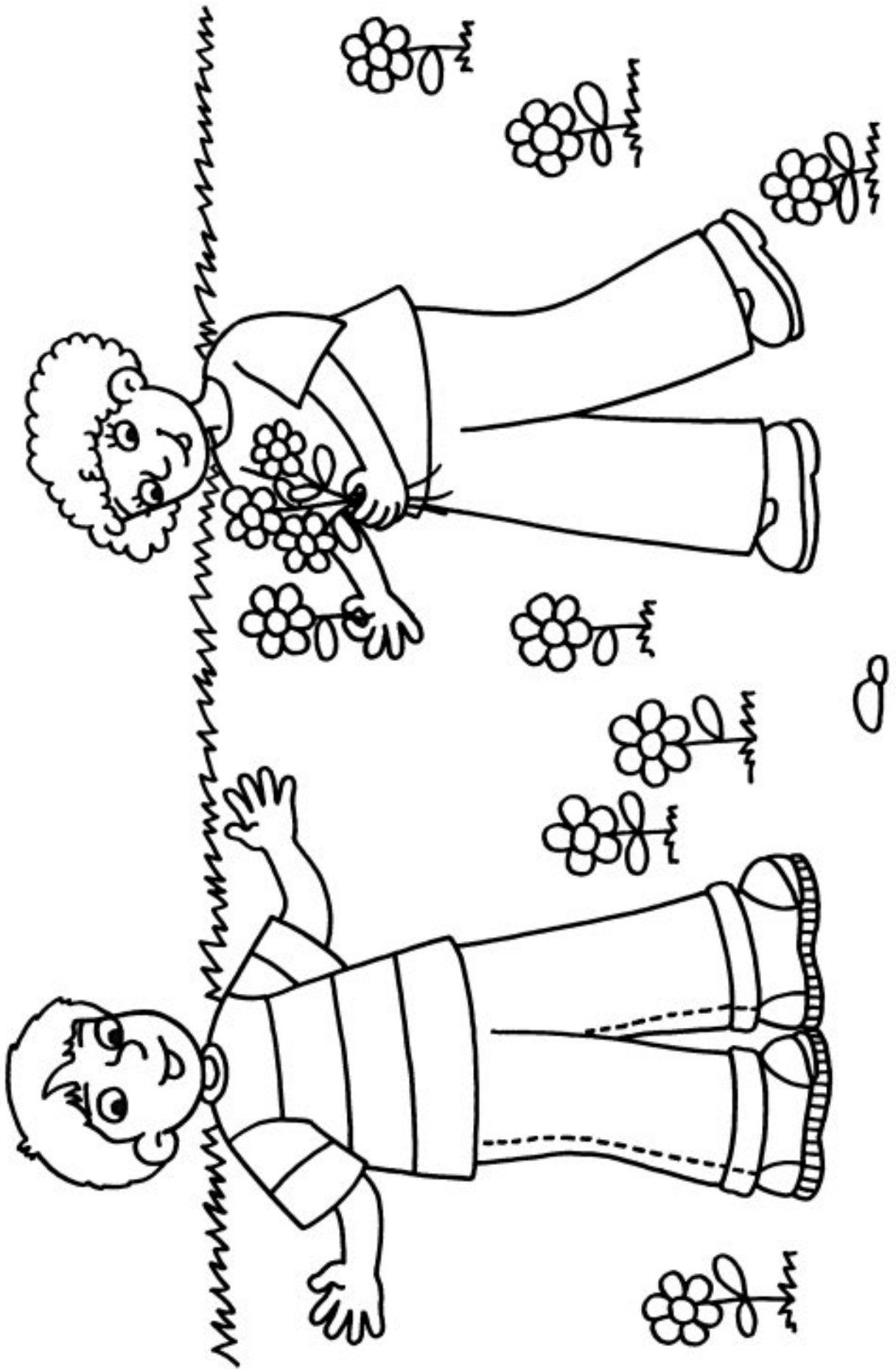

PAREJAS



1 2 3 4 5 6

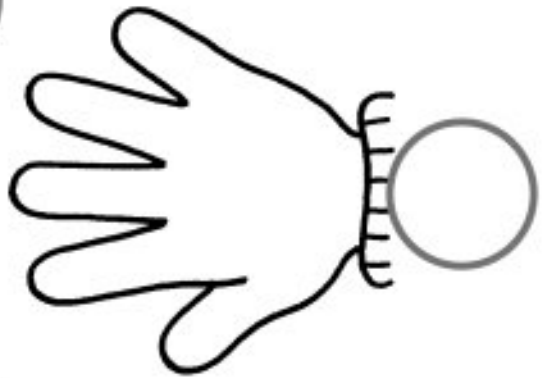
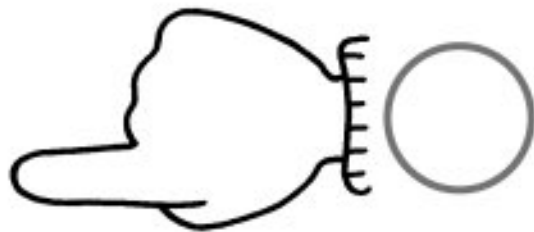
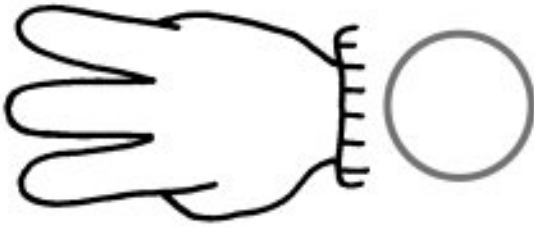
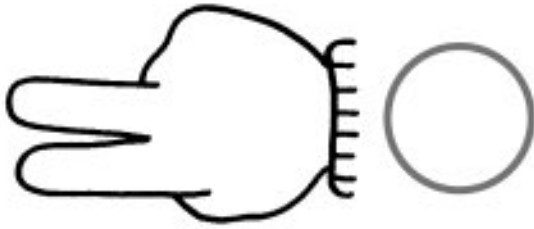
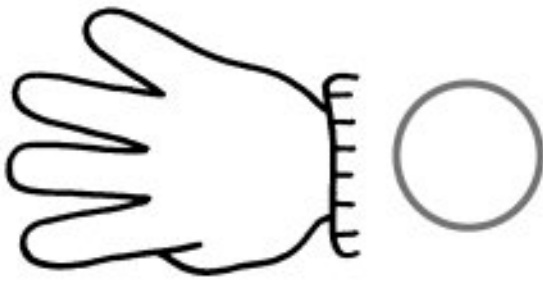

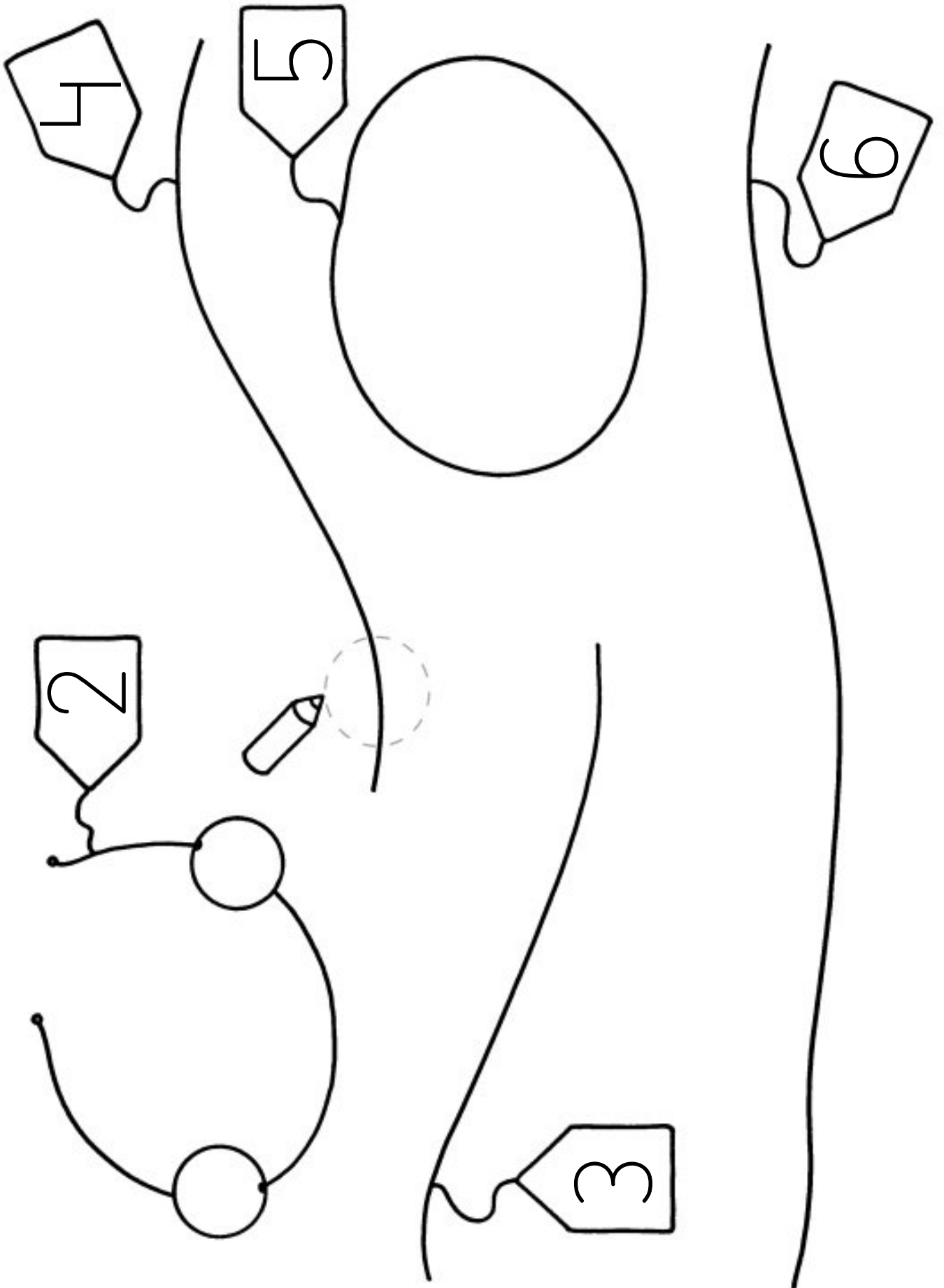

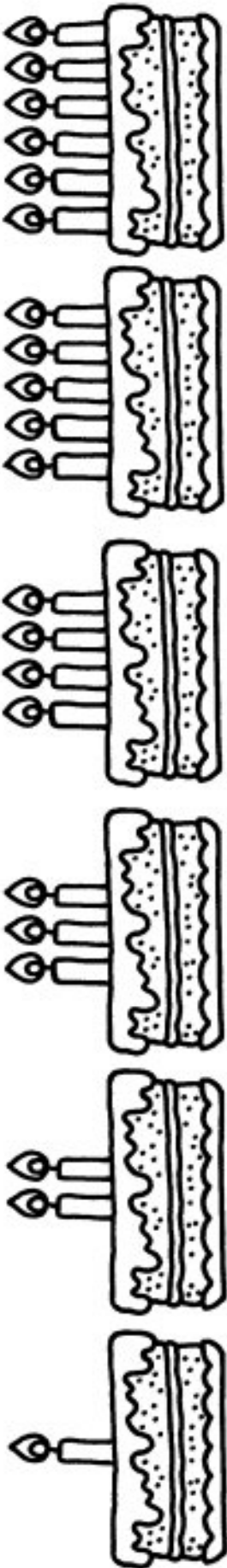

1 2 3 4 5 6

1	2	3	4	5	6
---	---	---	---	---	---

1	2	4	6		
---	---	---	---	--	--

1			5		
---	--	--	---	--	--

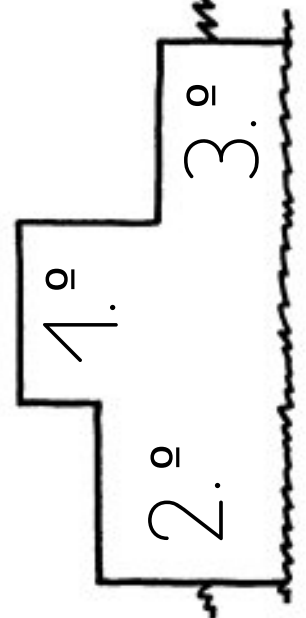
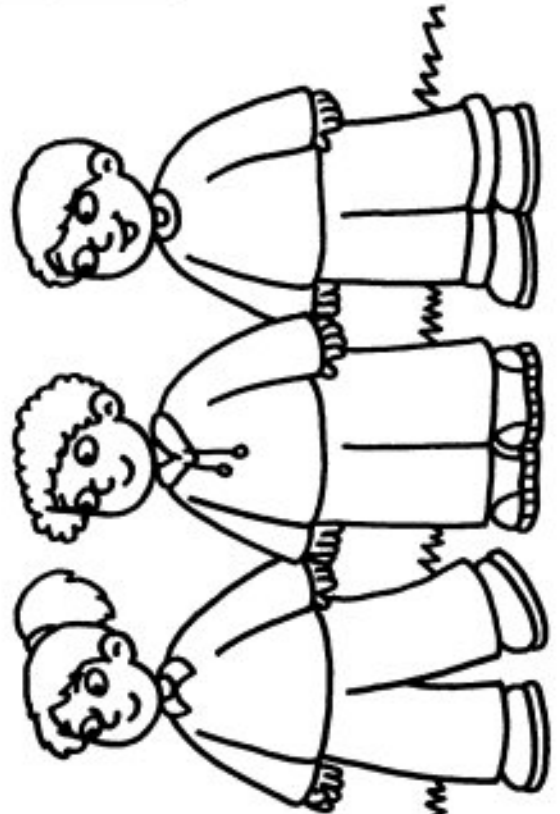
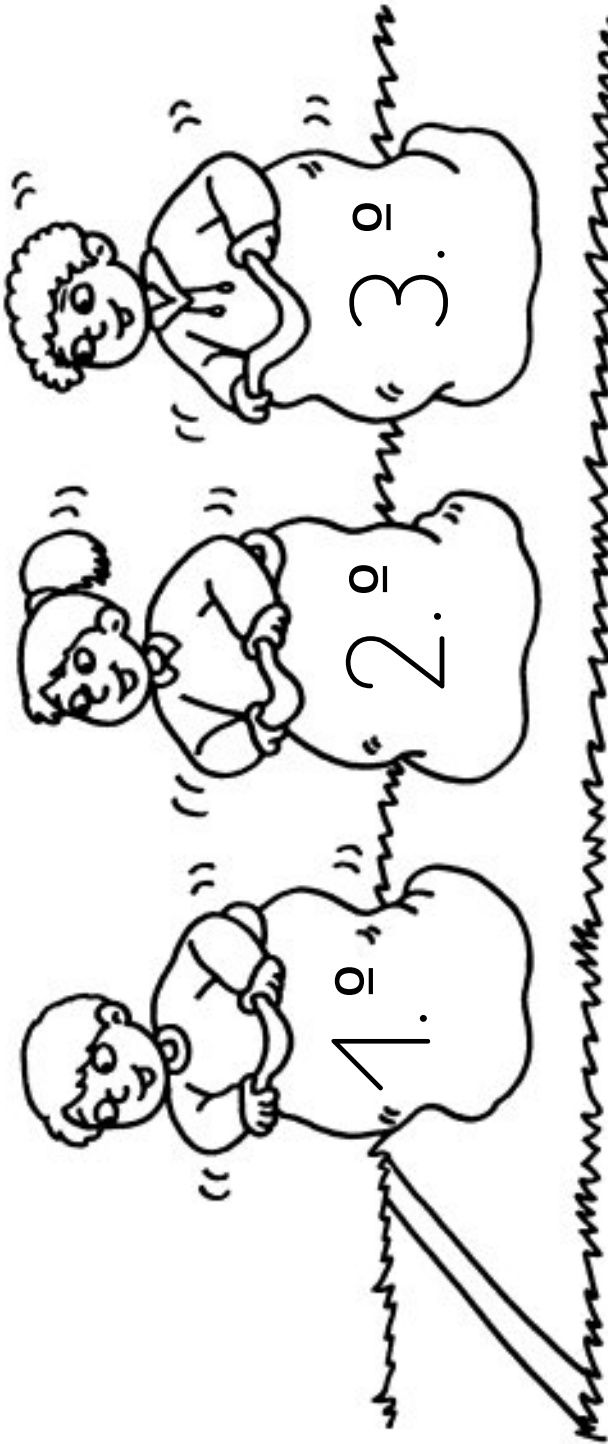
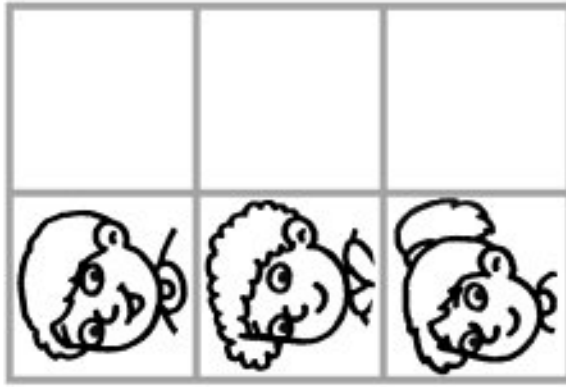

5

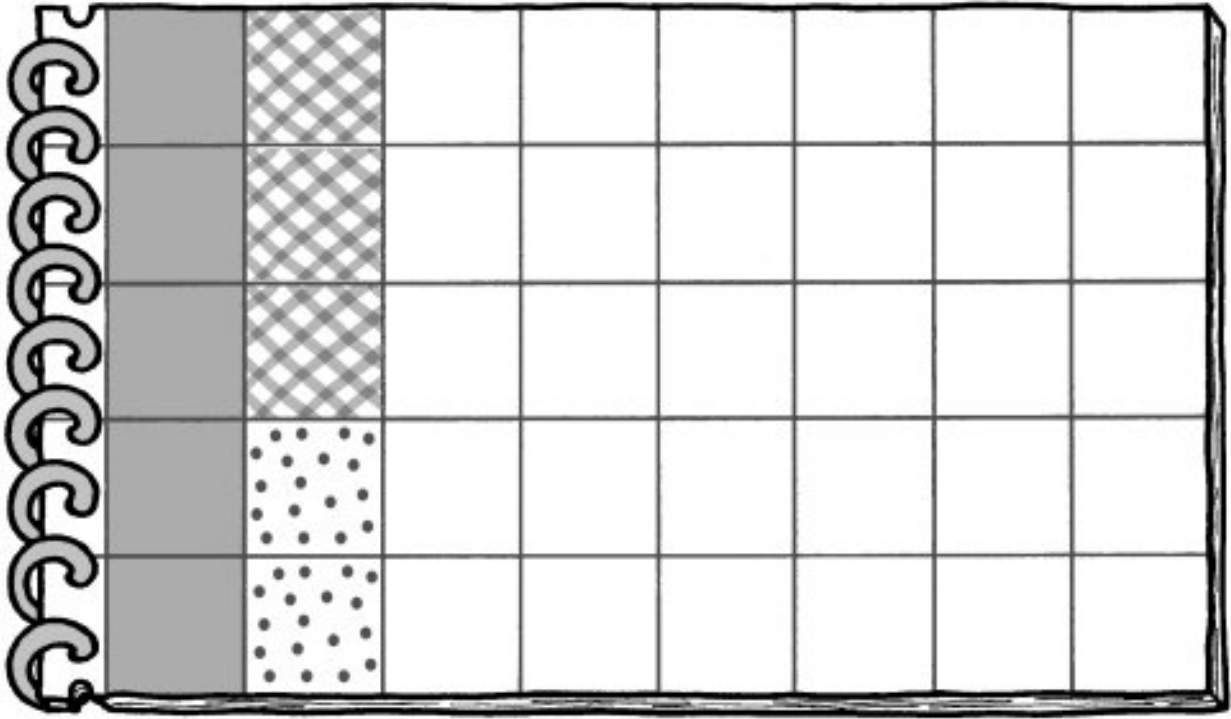

4

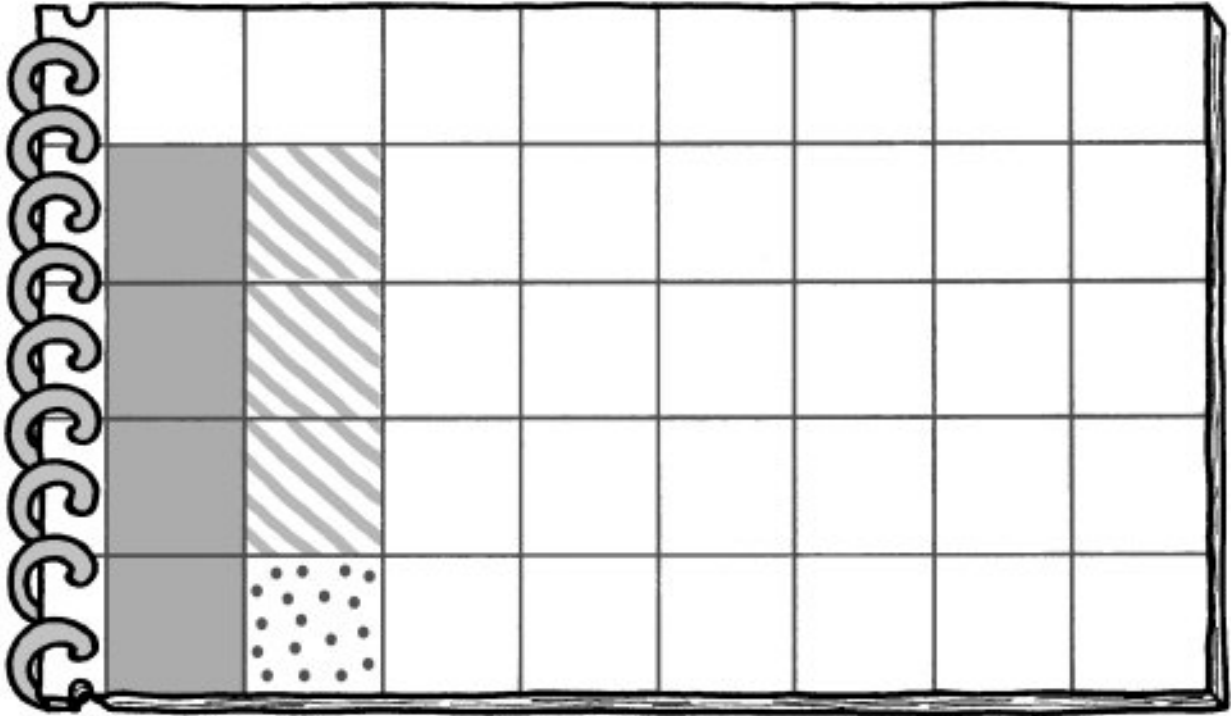

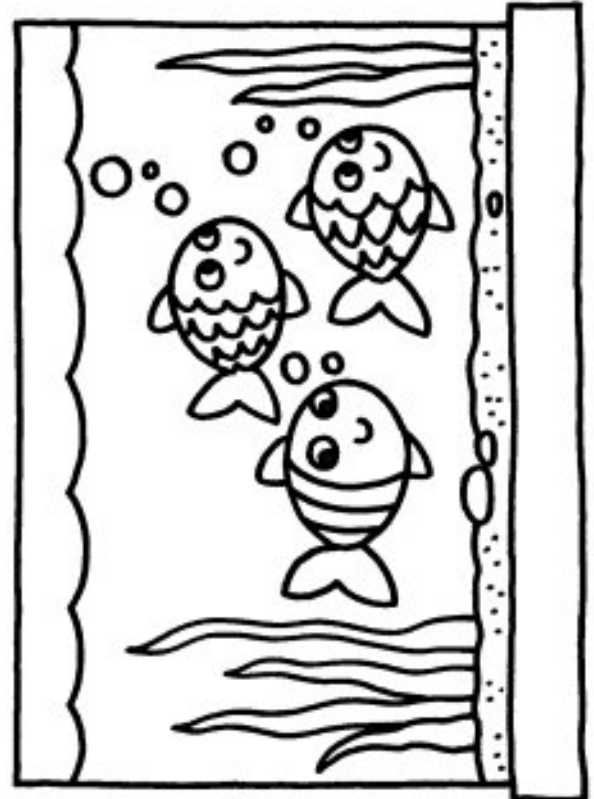
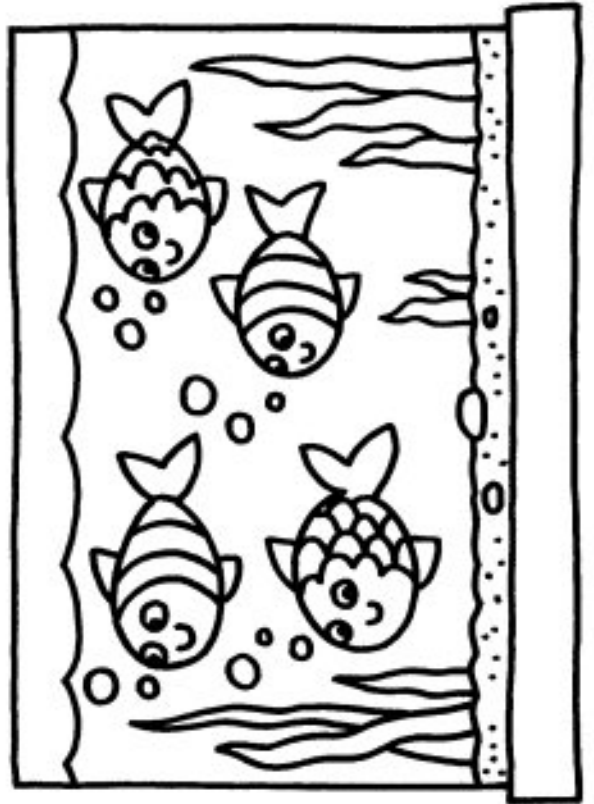
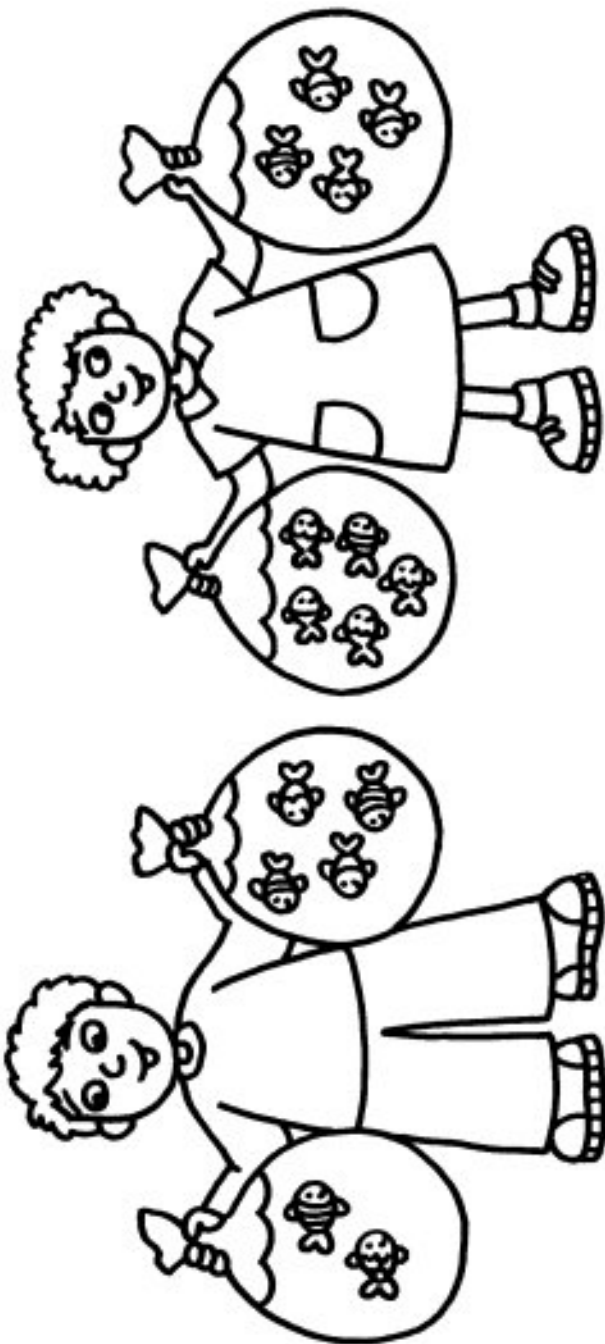
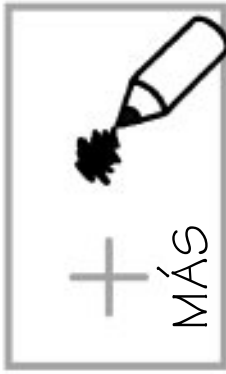

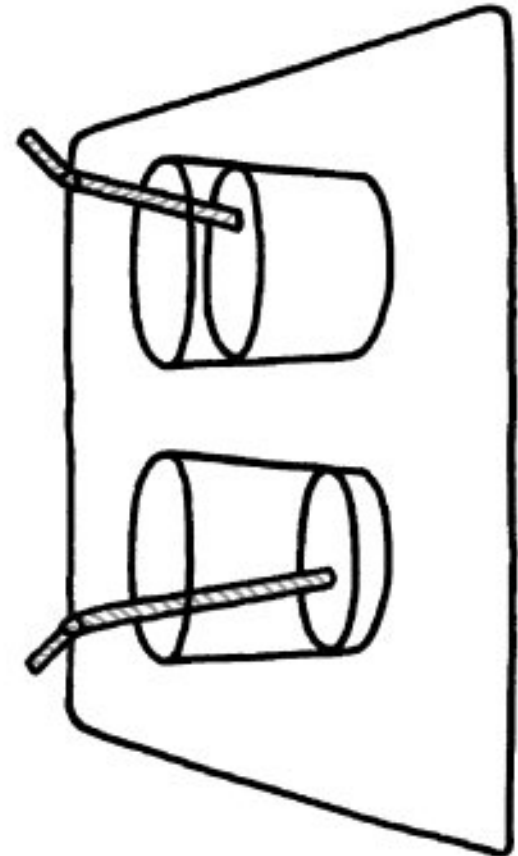
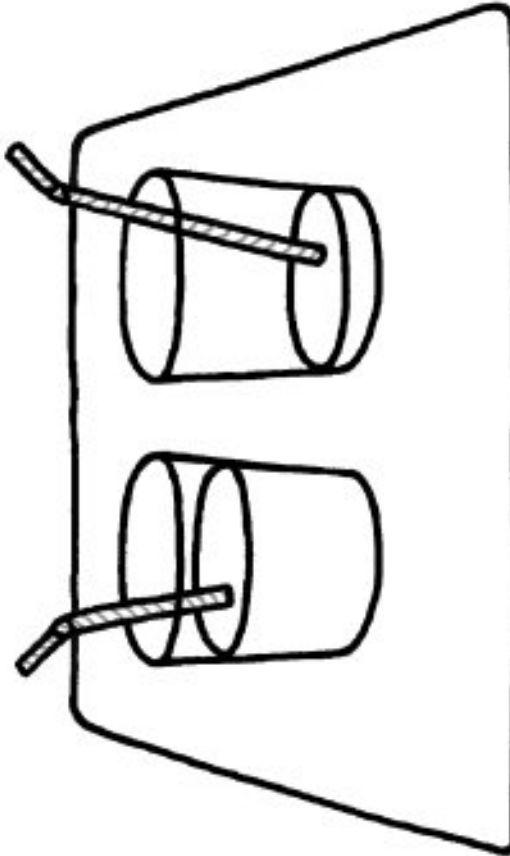
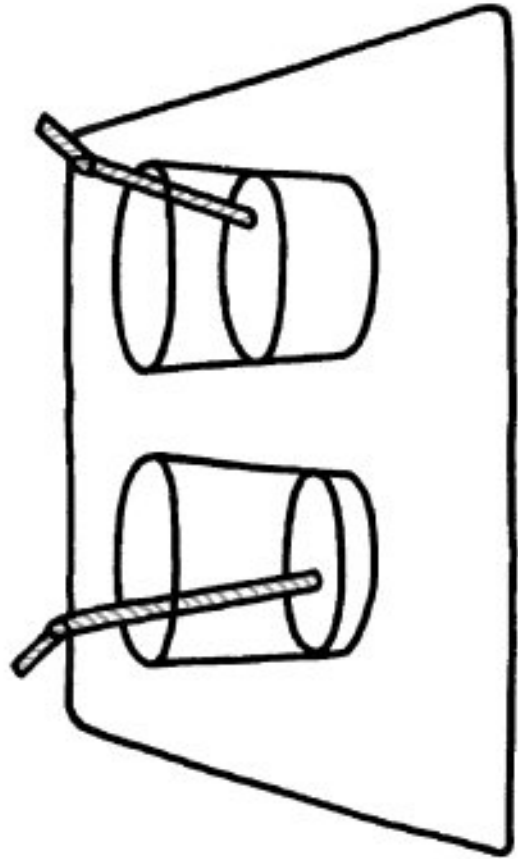
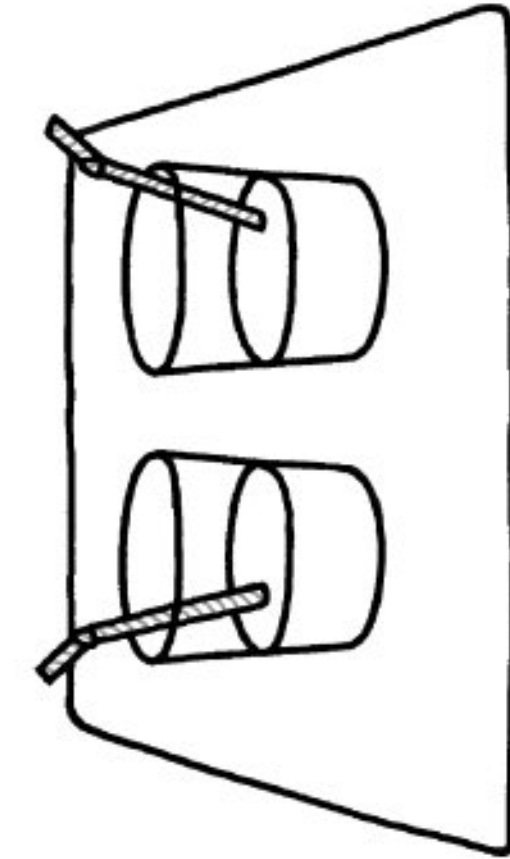
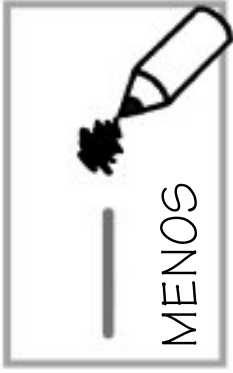

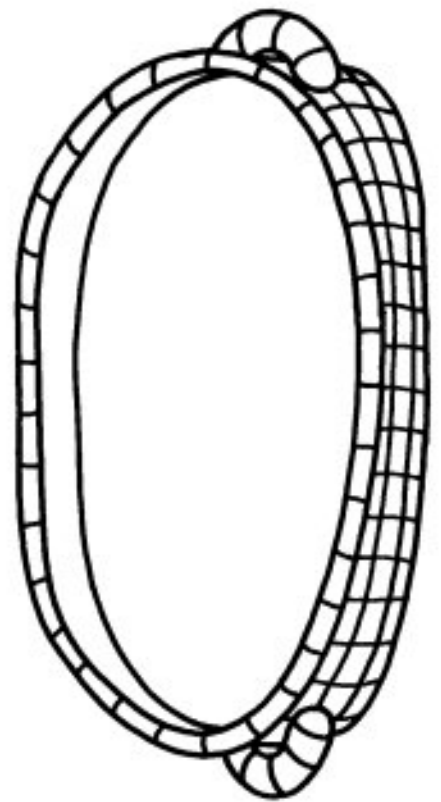
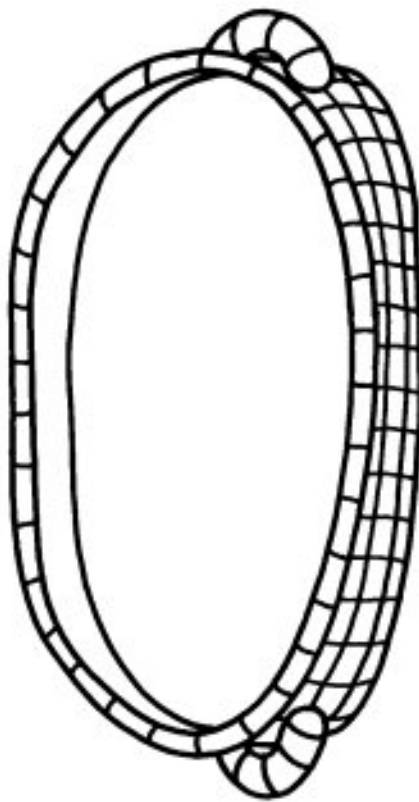

IGUAL

||

||

||

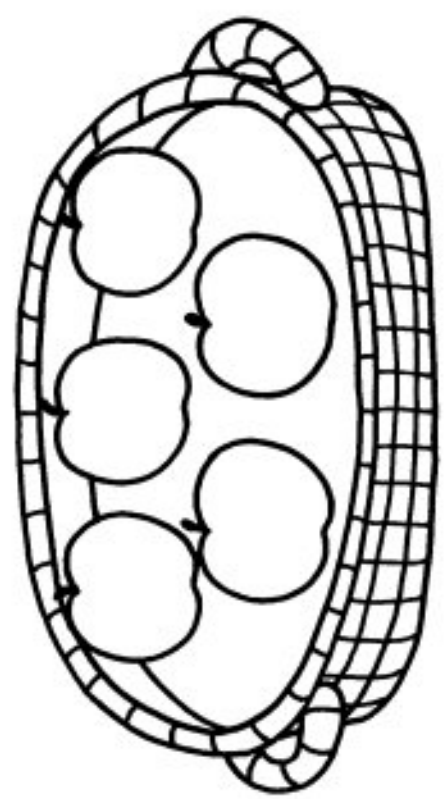
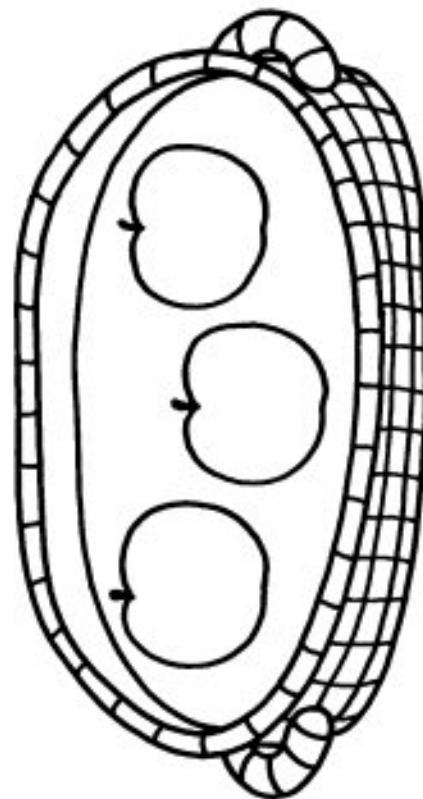
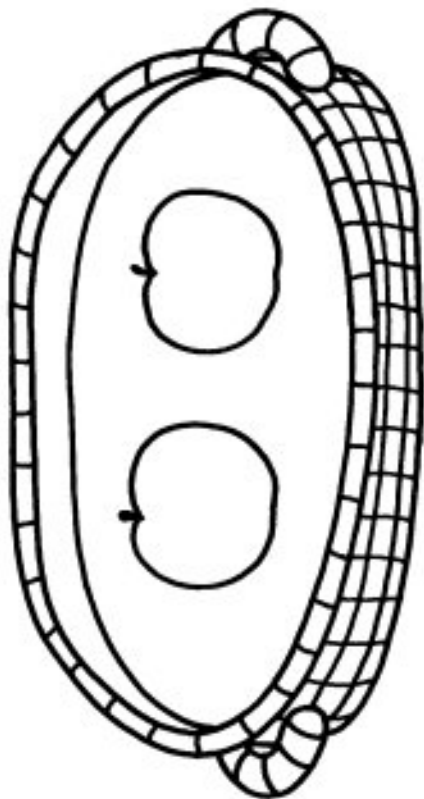

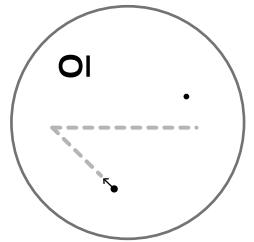
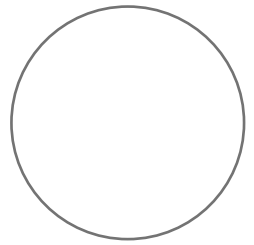
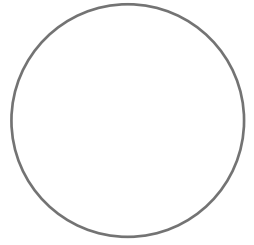
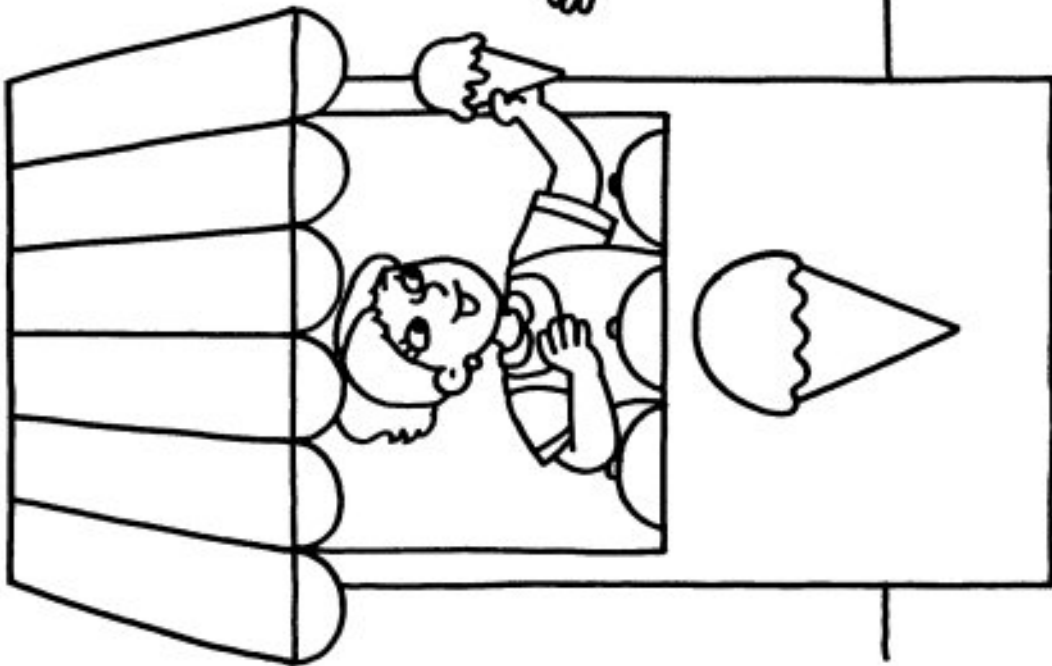
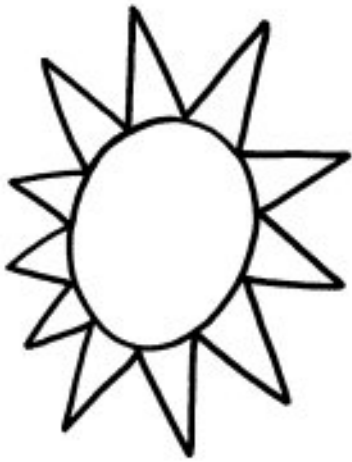

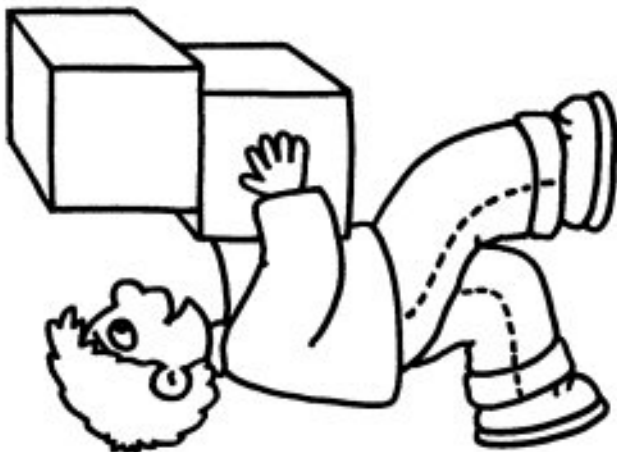
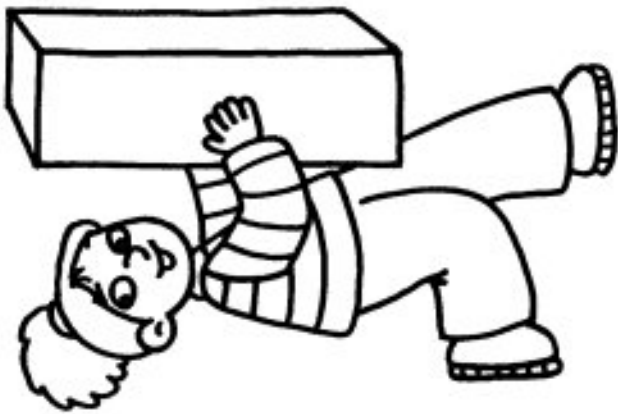
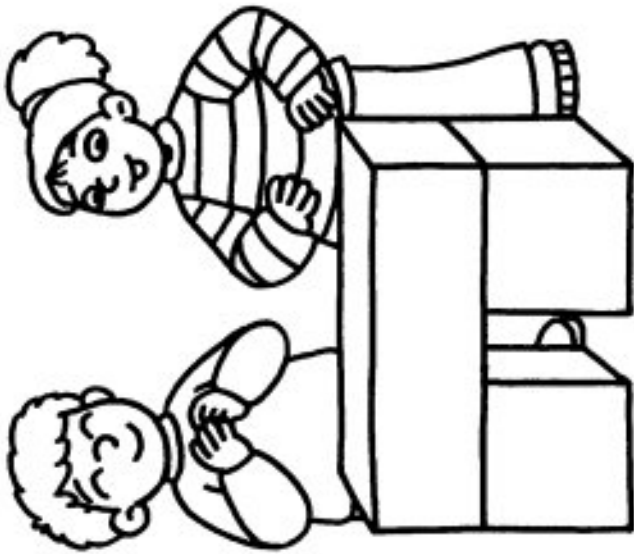

SON

||

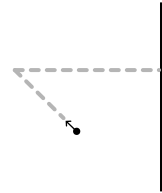

Y

+

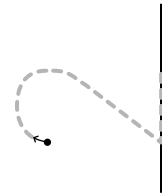

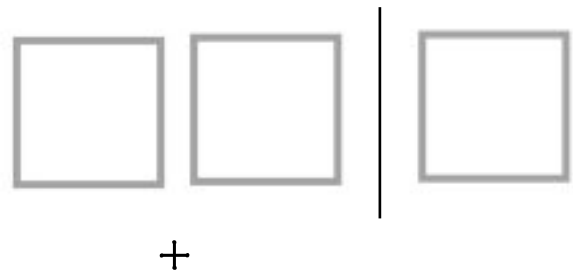
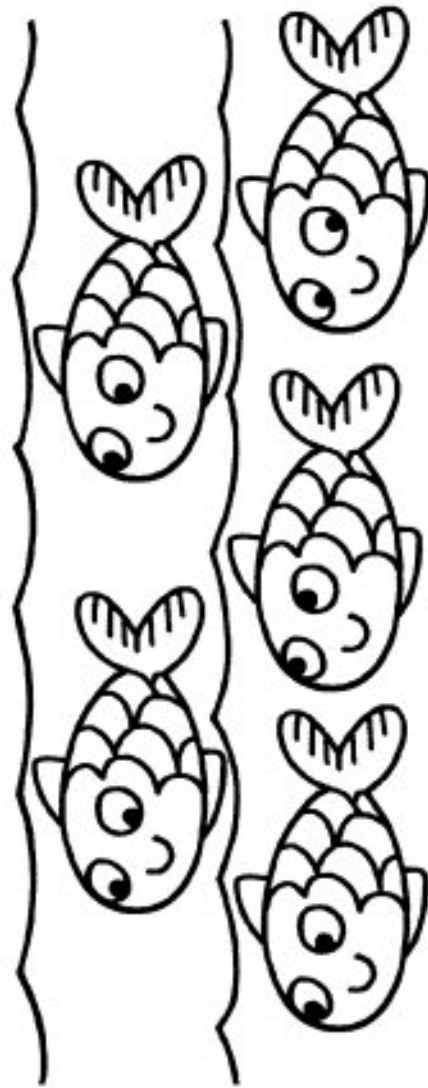
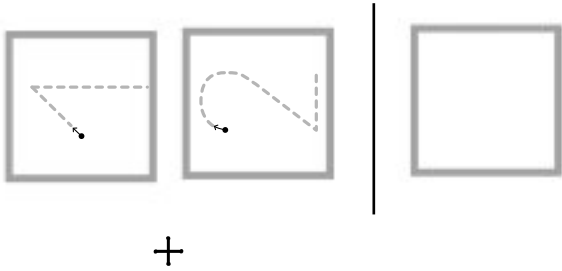

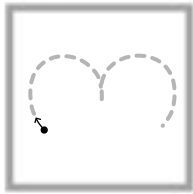

||

||

||

||

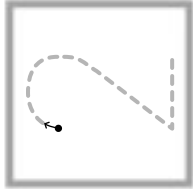

+

+

+

+

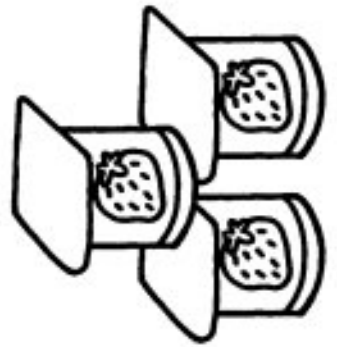
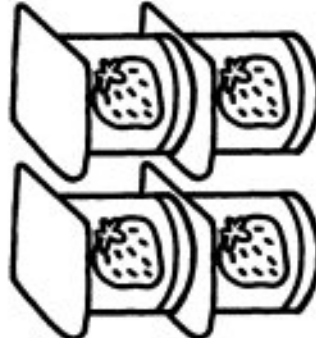
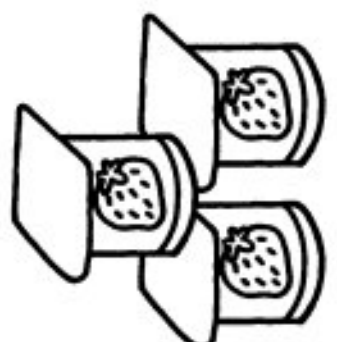
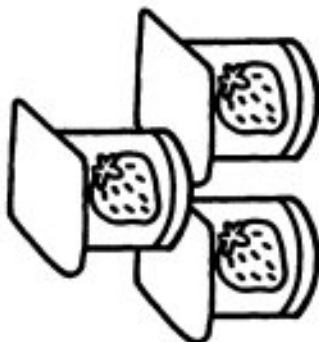
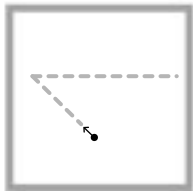

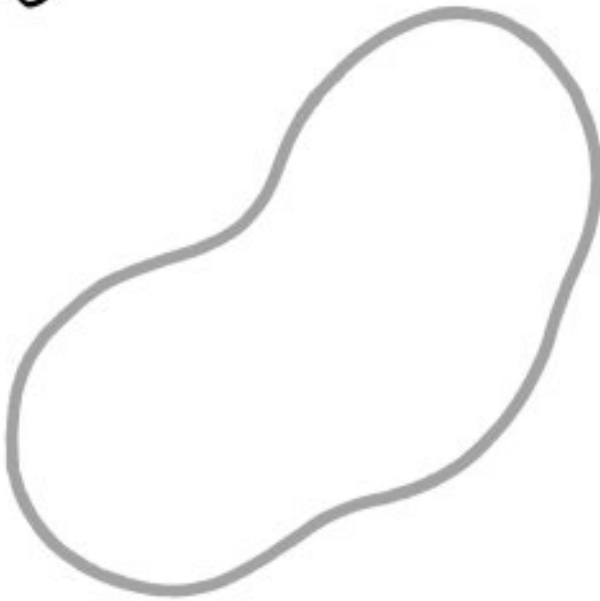
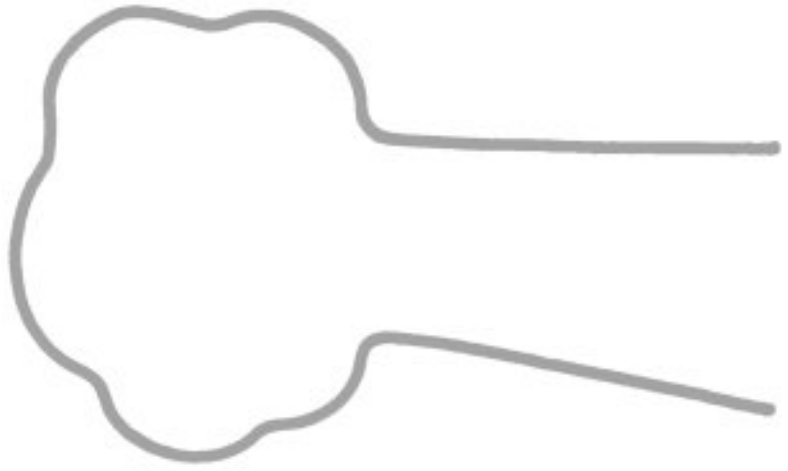
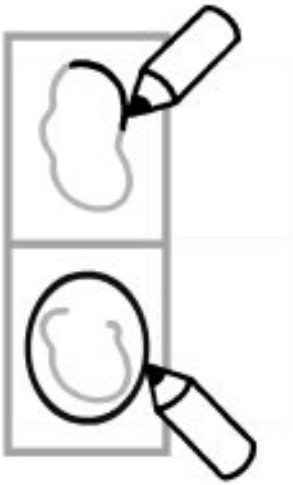

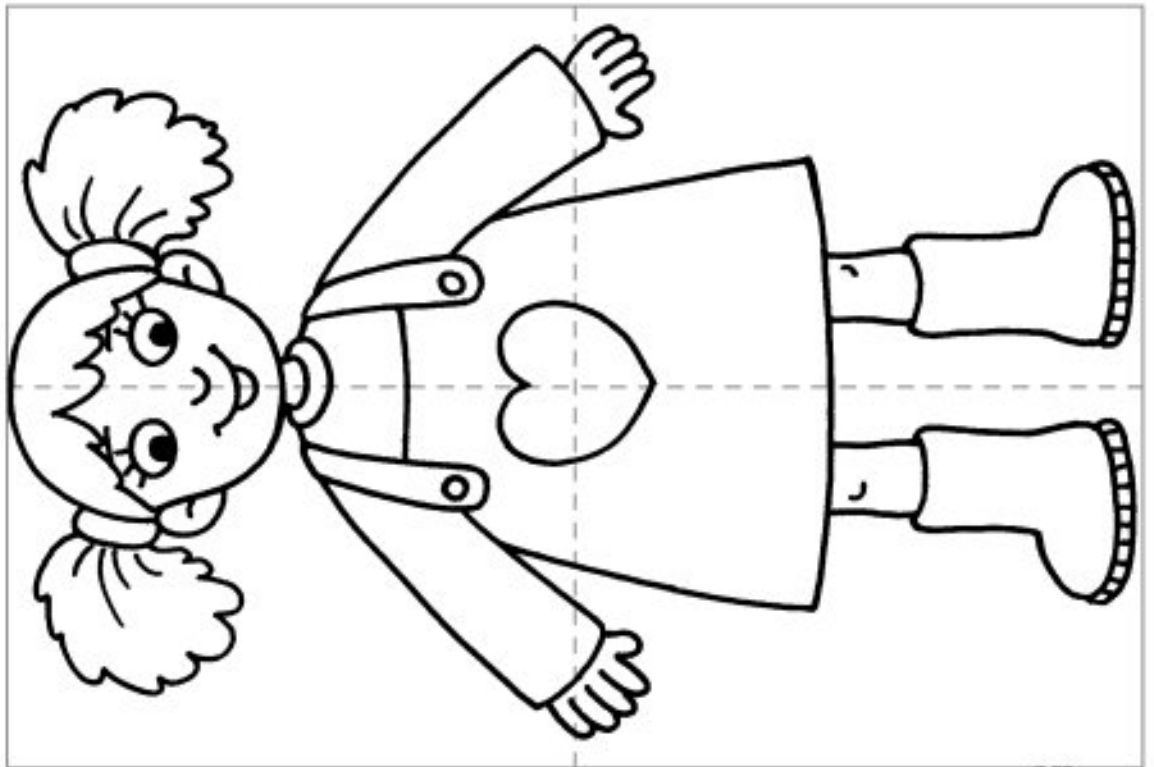
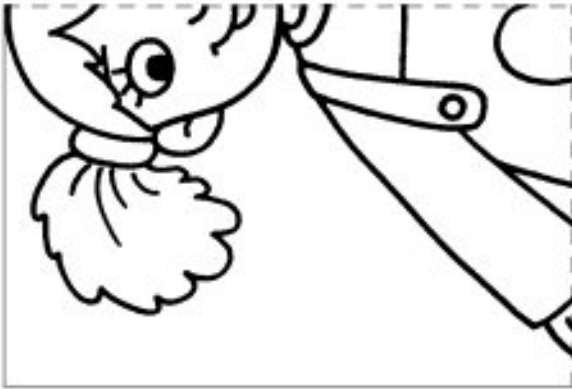
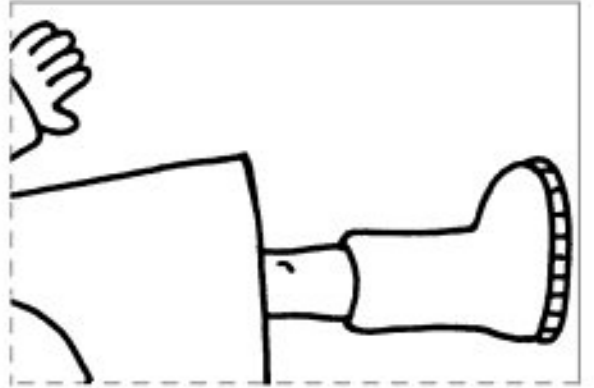
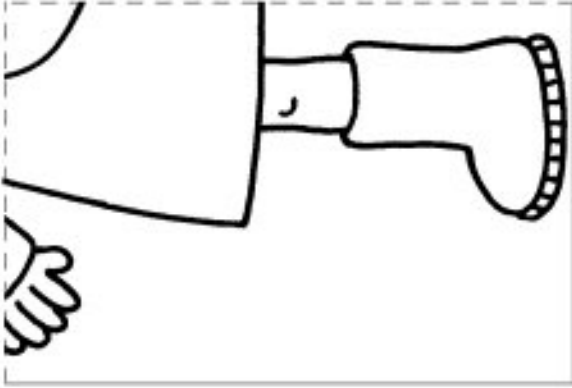

EN MEDIO

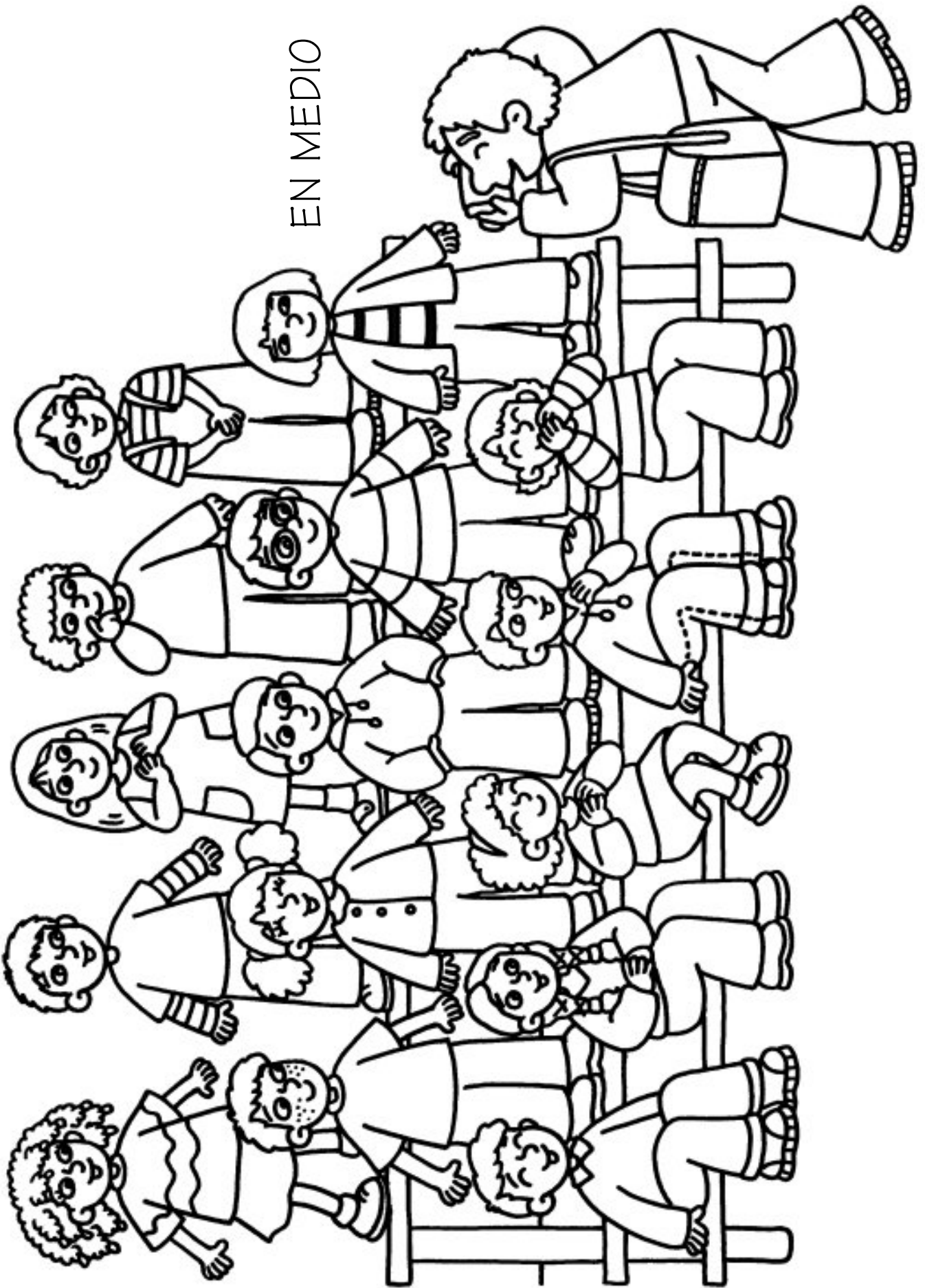

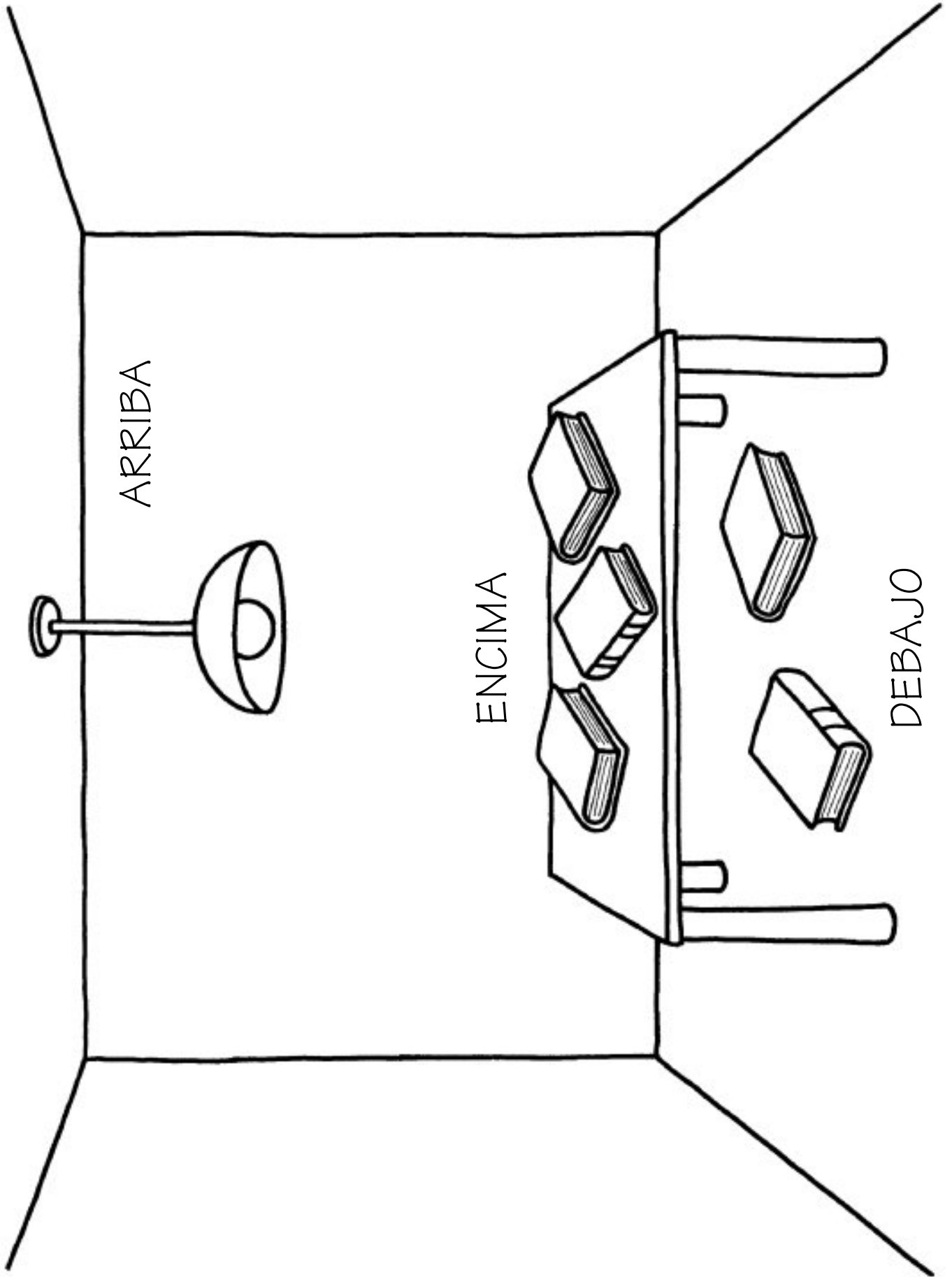

FUERA

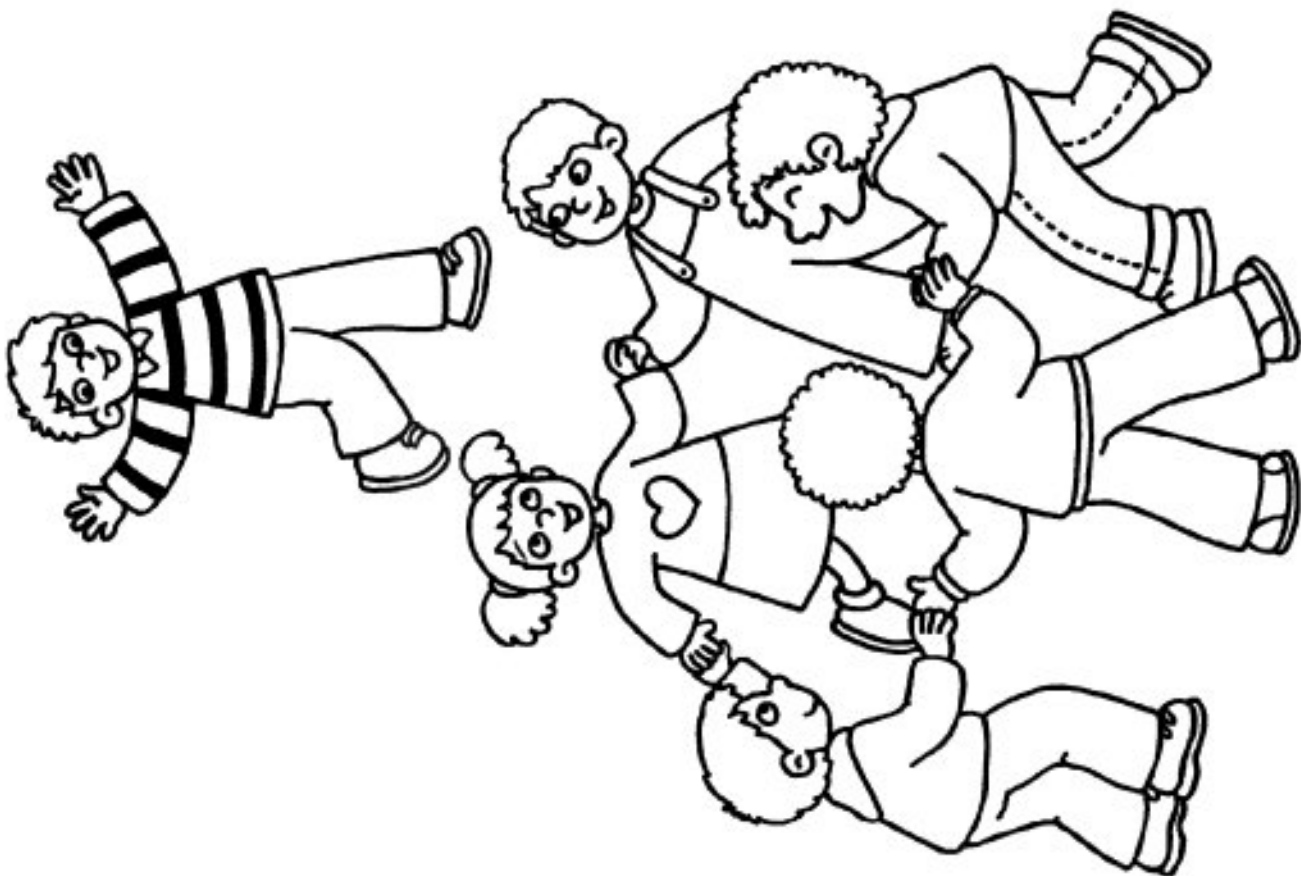

DENTRO

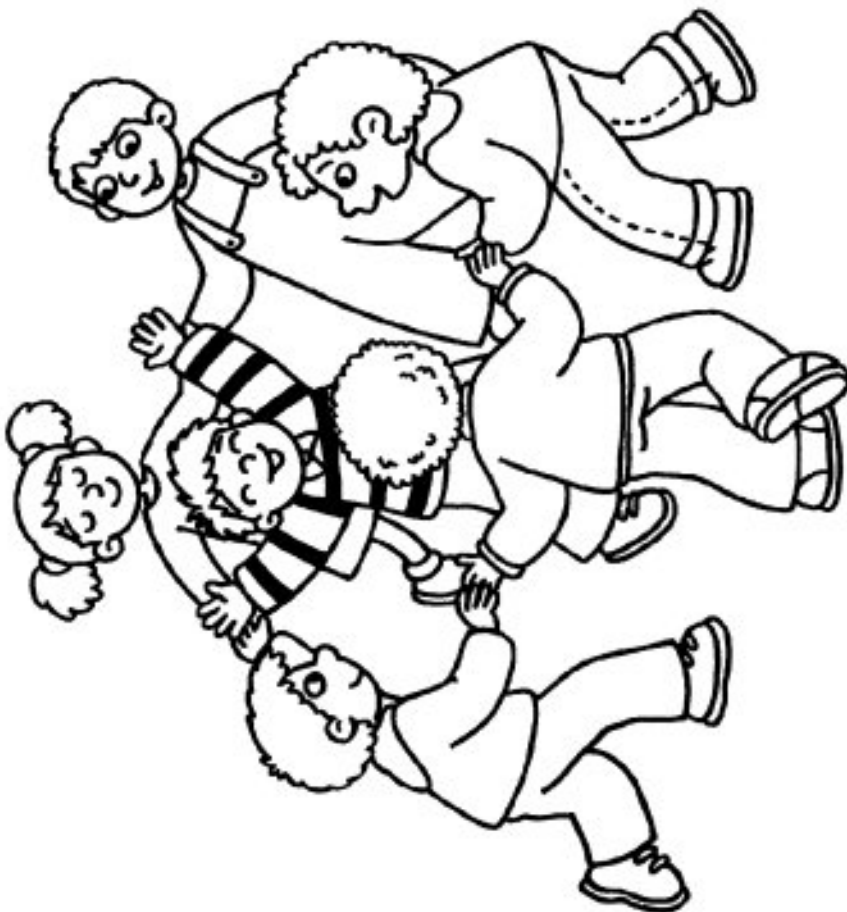

DENTRO FUERA

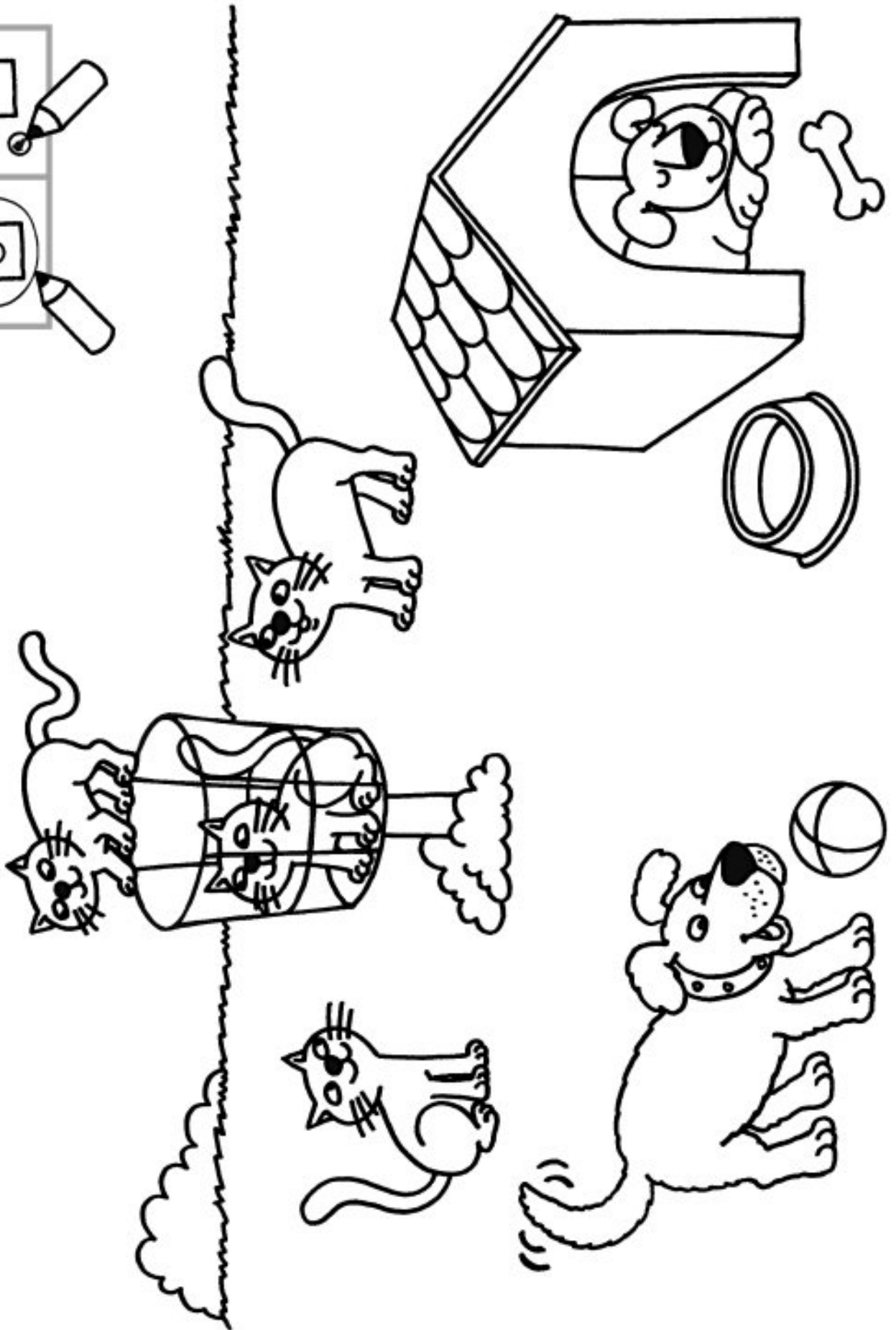
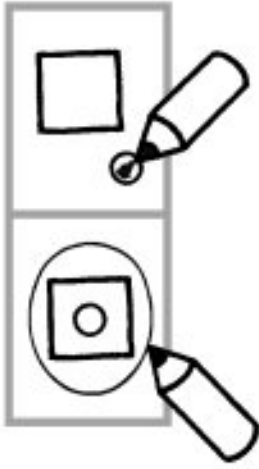

DENTRO

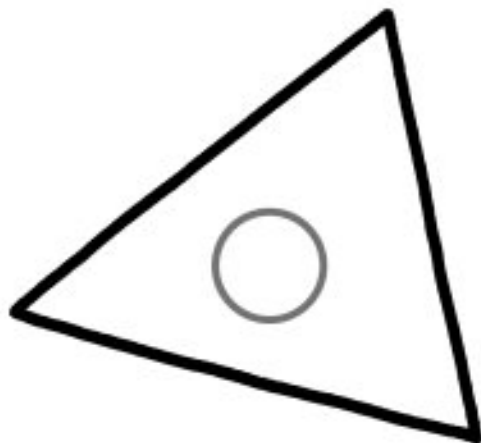
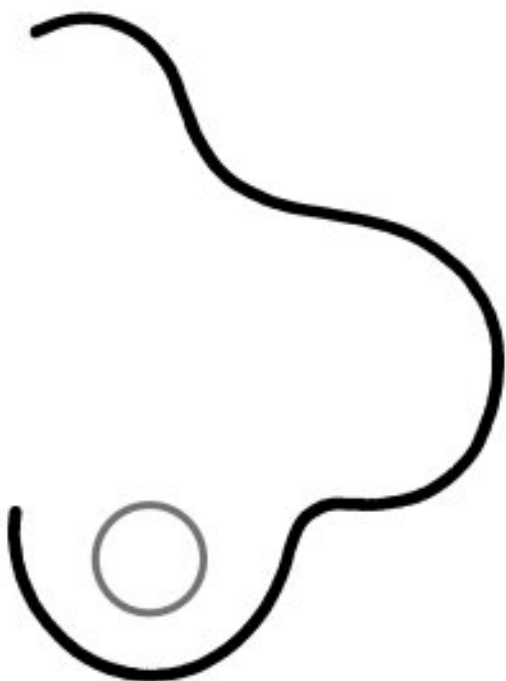
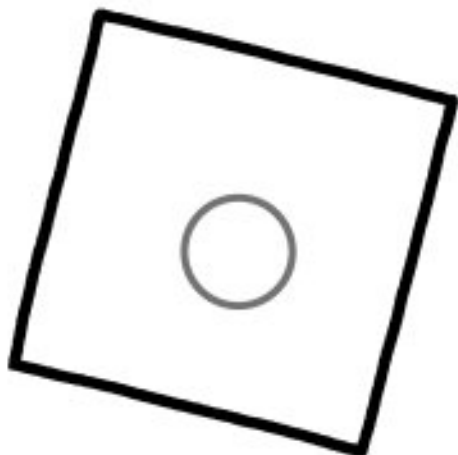

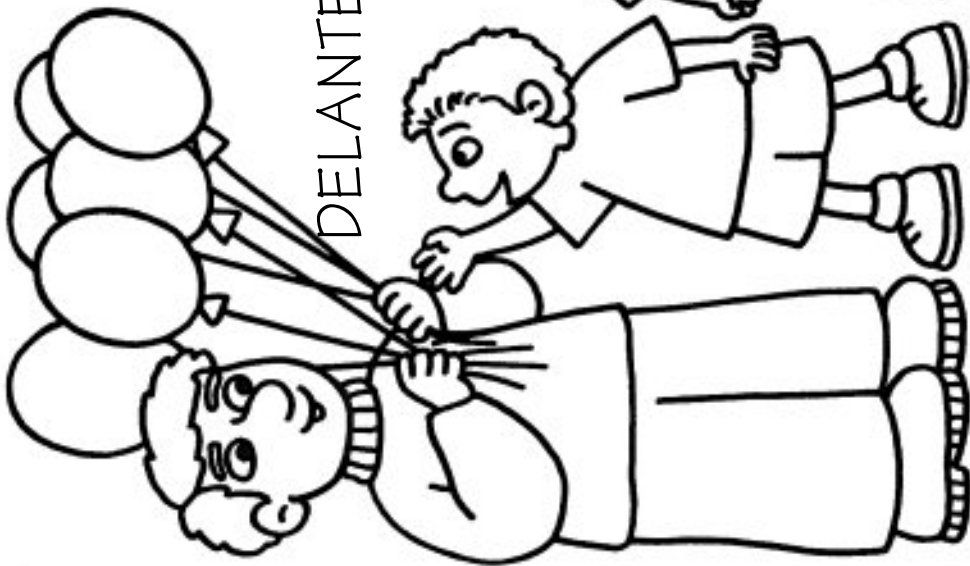

DELANTE

DETRÁS

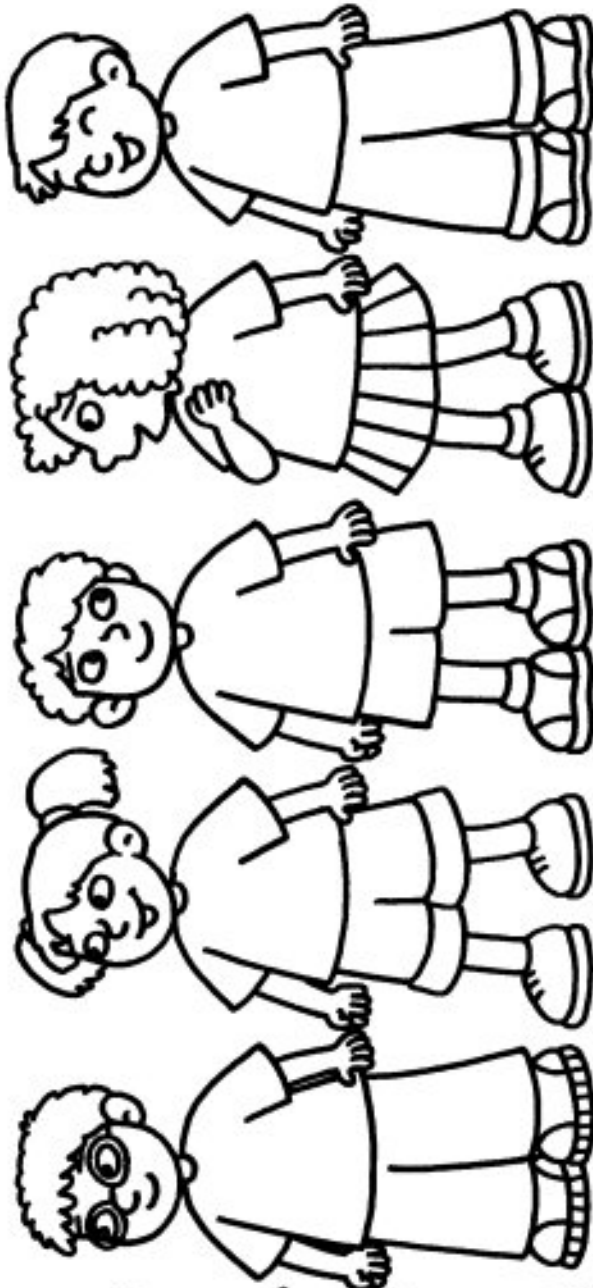

DELANTE

DETRÁS

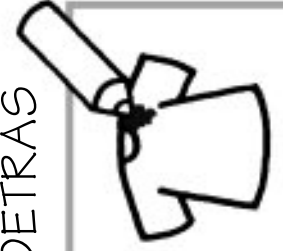
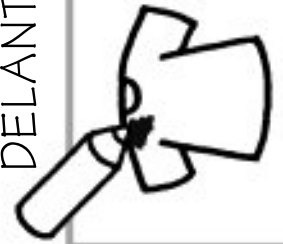

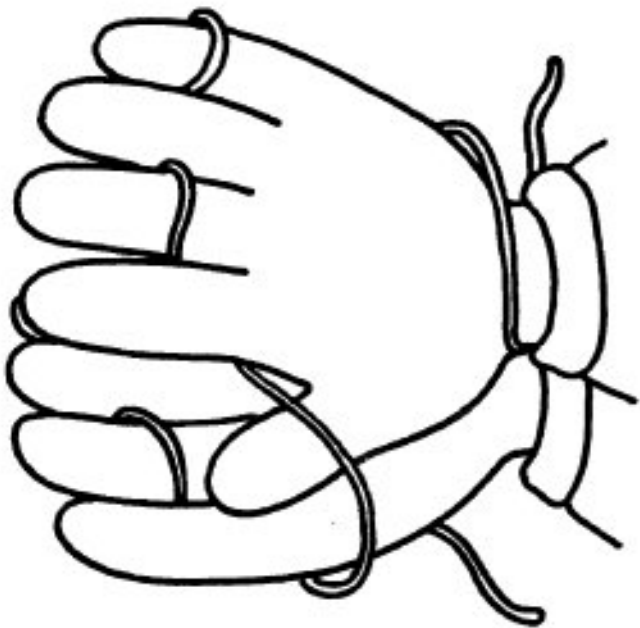

JUNTAS

SEPARADAS

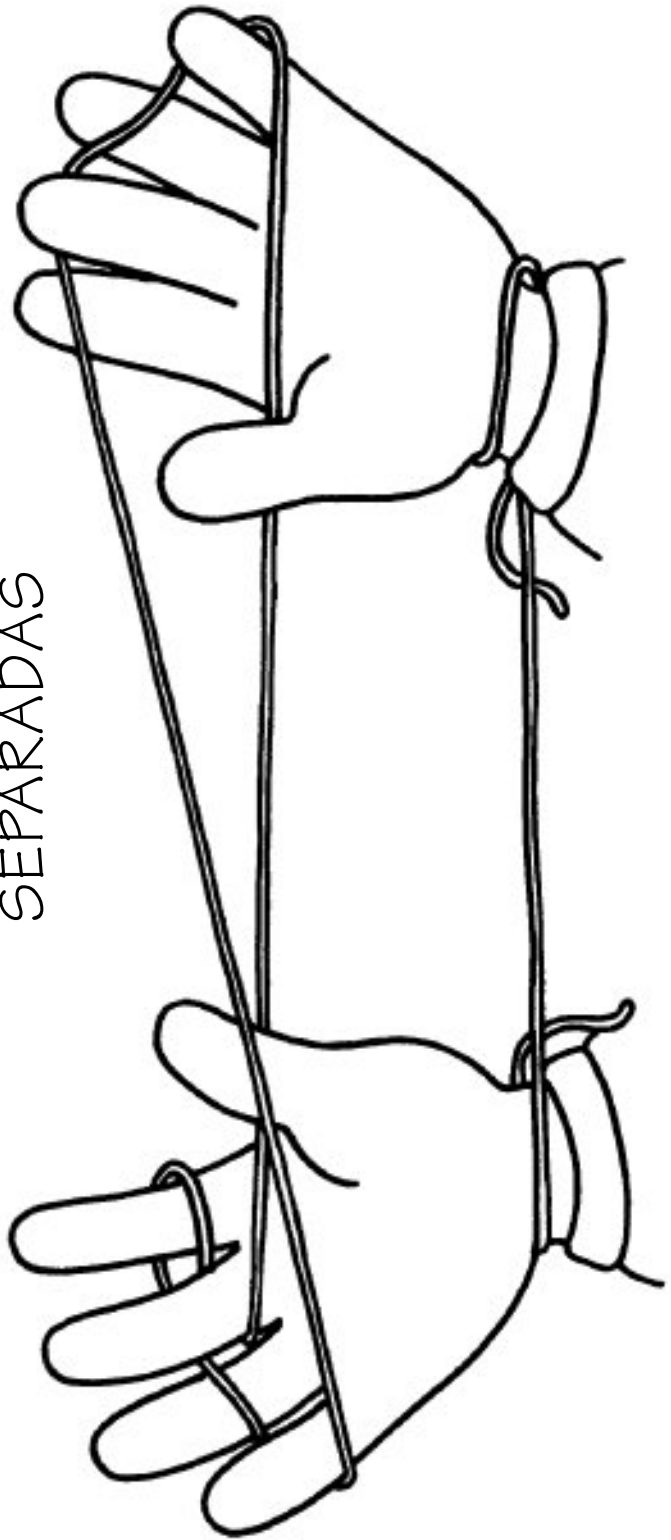

ALREDEDOR

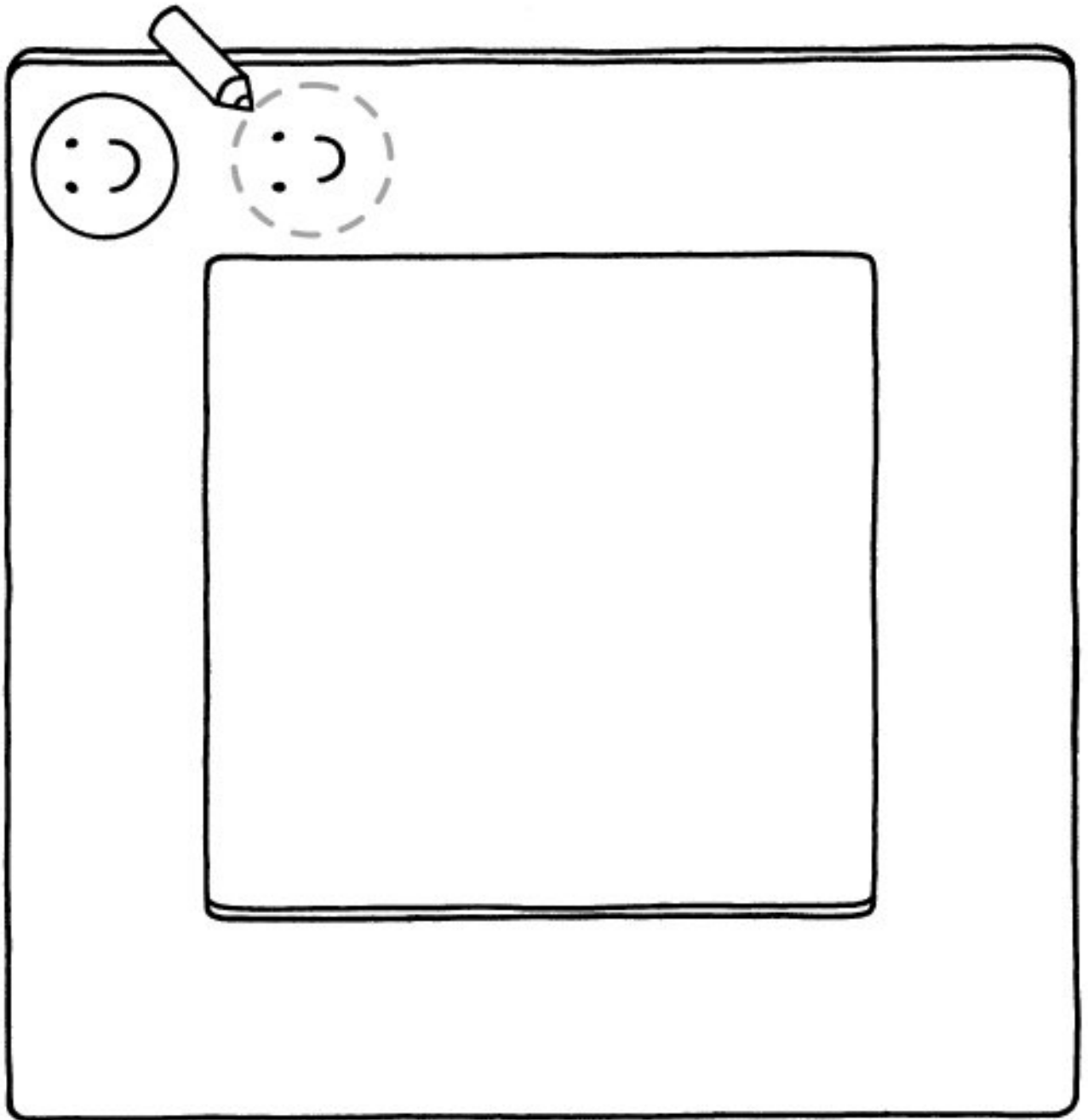

LARGO CORTO

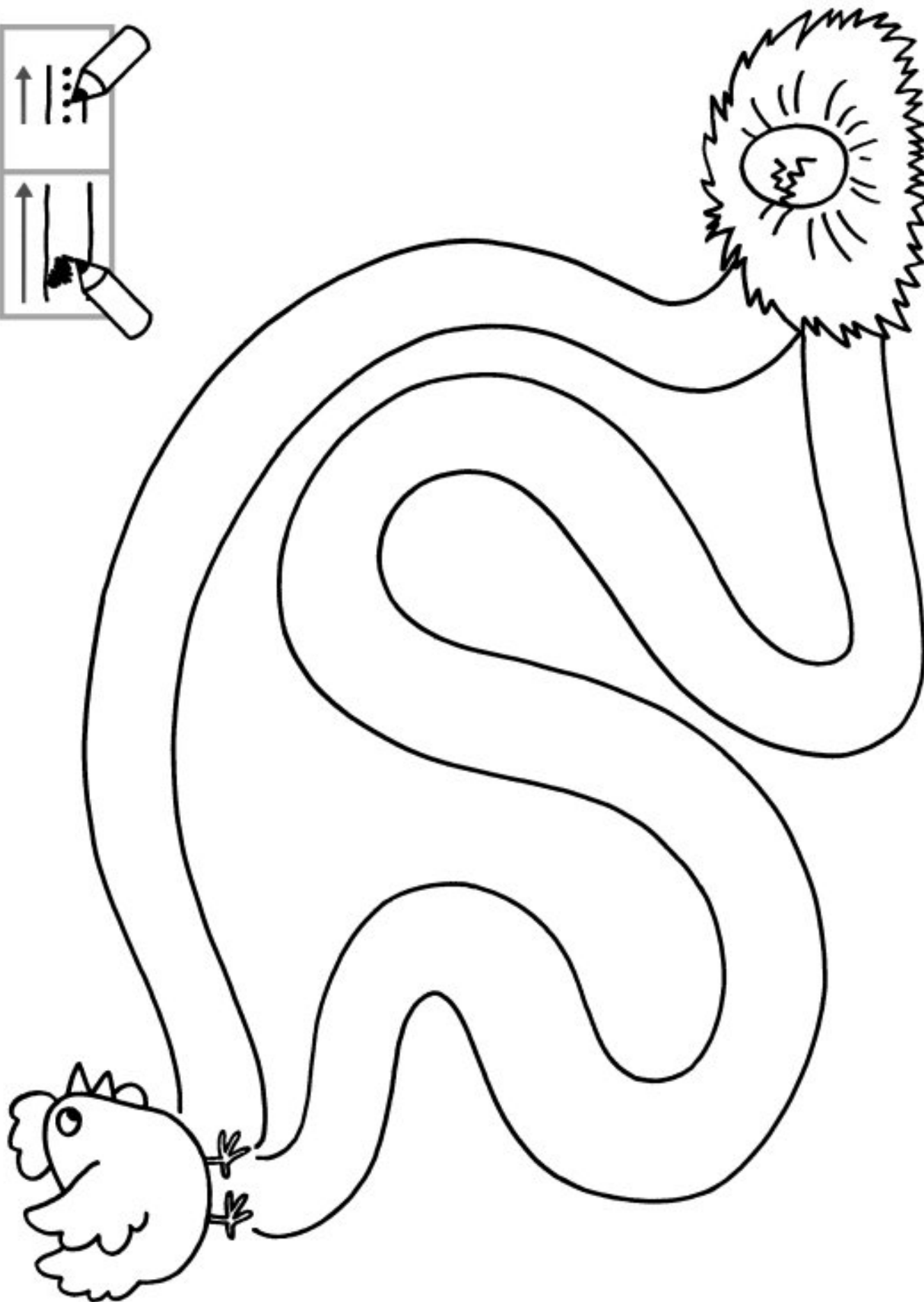
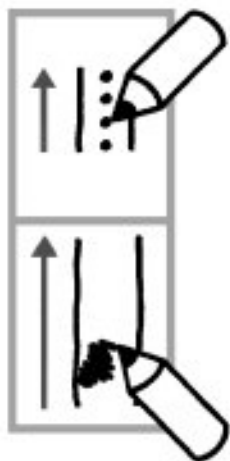

ANCHO ESTRECHO

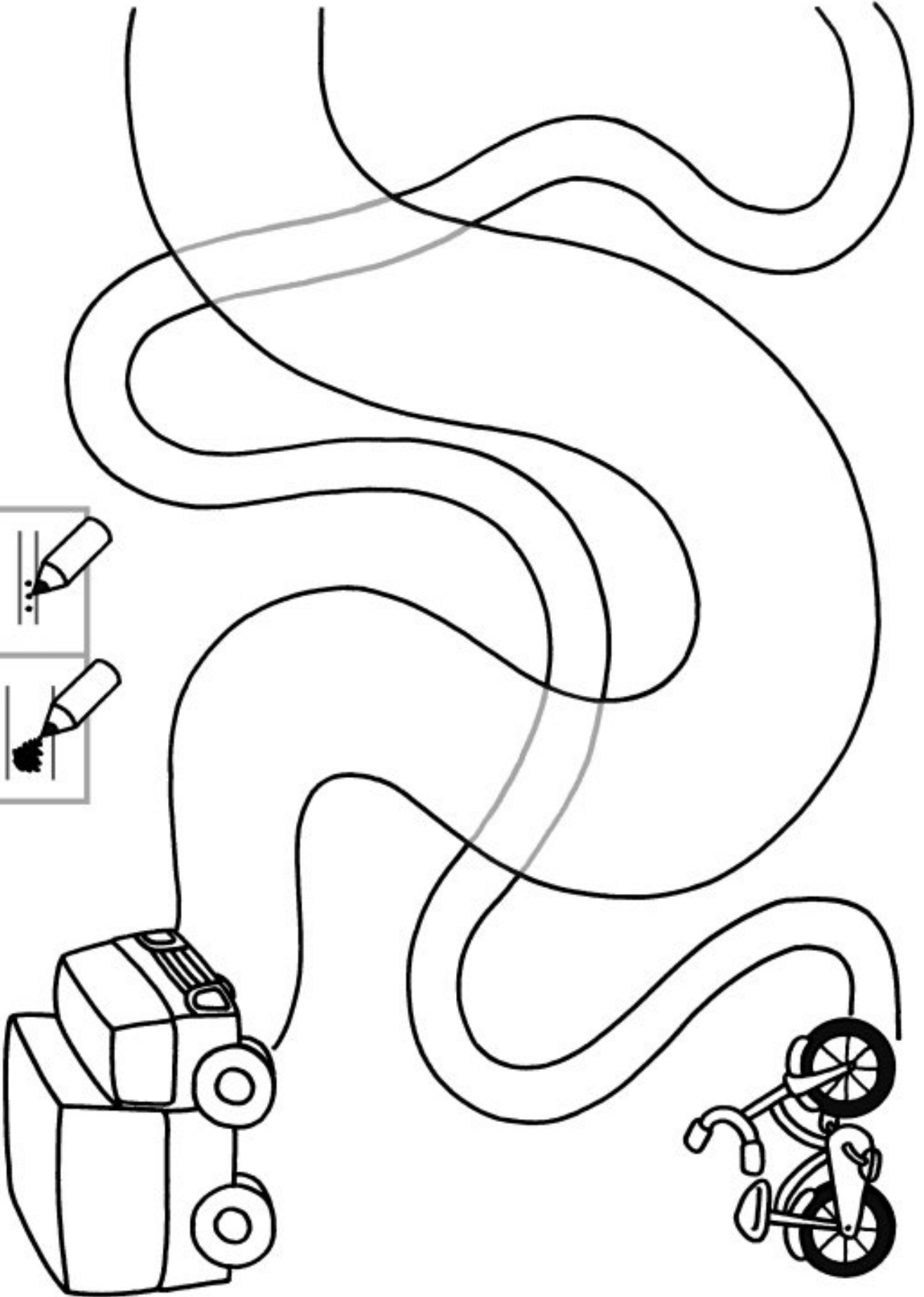
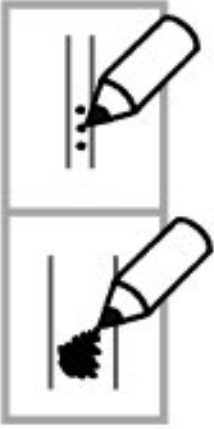

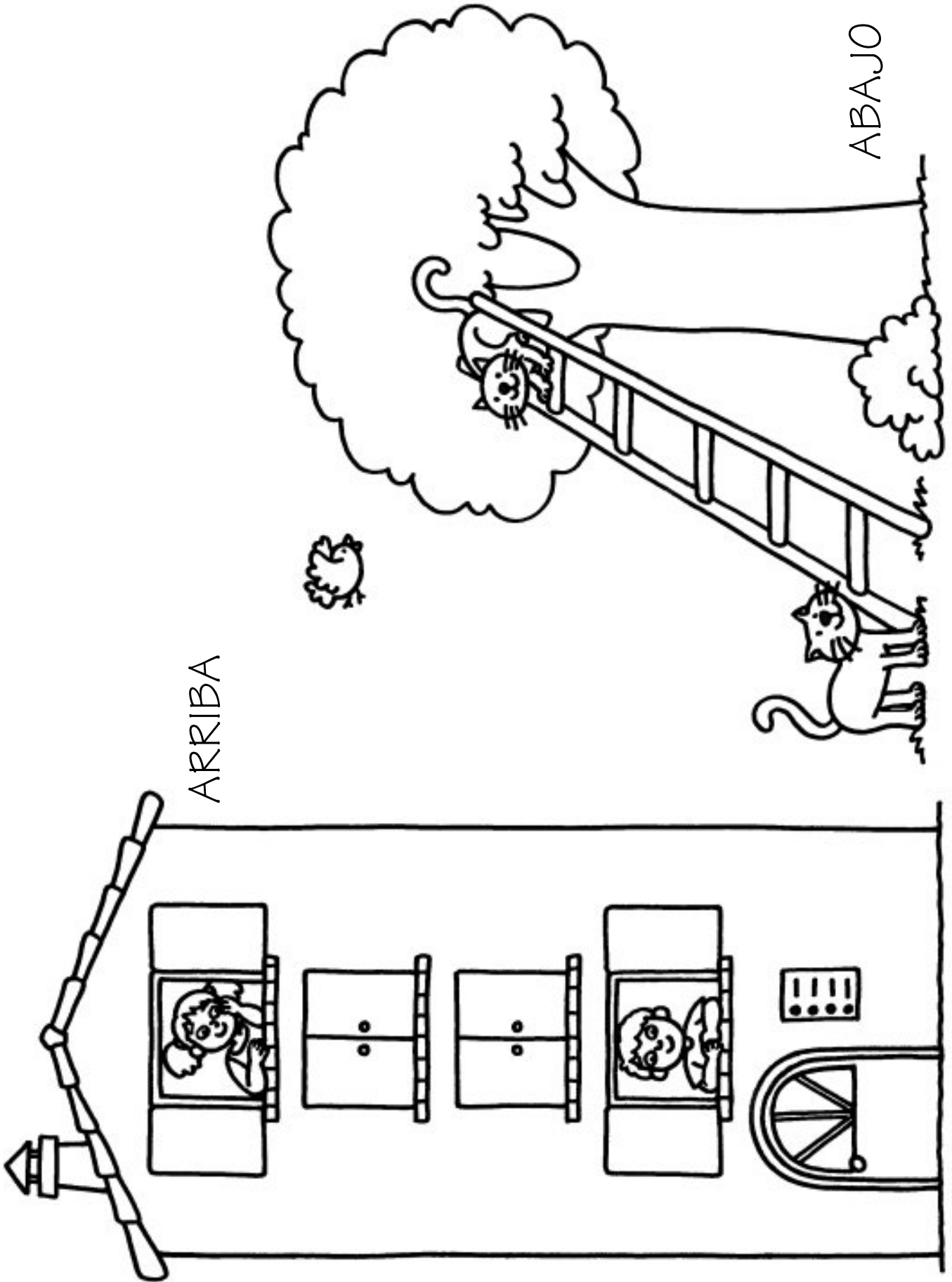

ARRIBA

ABAJO