

# TEMA 12

## PORTAS LÓXICAS



# ÍNDICE

- Porta O
- Porta AND
- Porta NOT
- Porta NOR
- Porta NAND
- Porta XOR

# FUNCIÓN SUMA LÓXICA: PORTA O

	<i>b</i>	<i>a</i>	<i>S</i>
0	0	0	0
1	0	1	1
2	1	0	1
3	1	1	1

Táboa de verdade

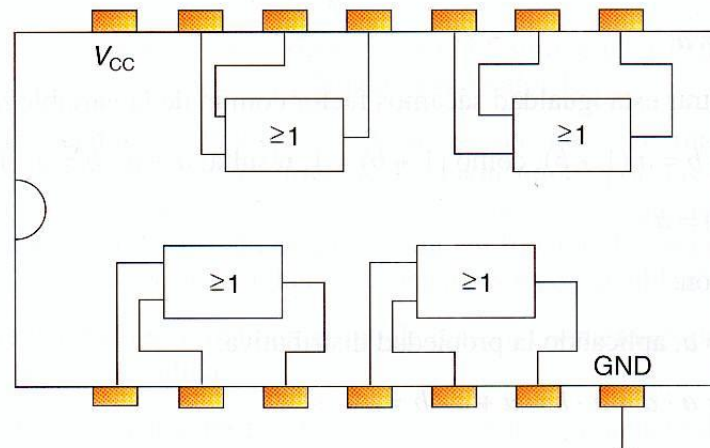
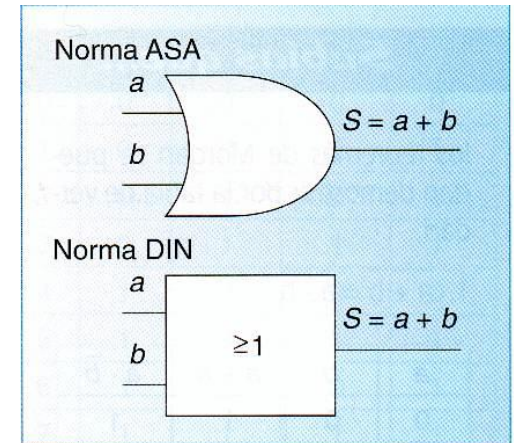
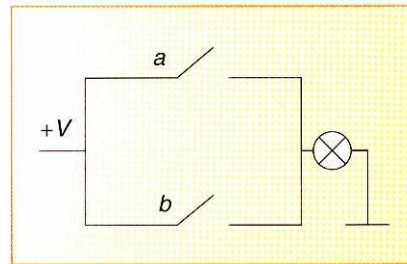

# FUNCIÓN PRODUCTO LÓGICO: PORTA AND

Táboa de verdade

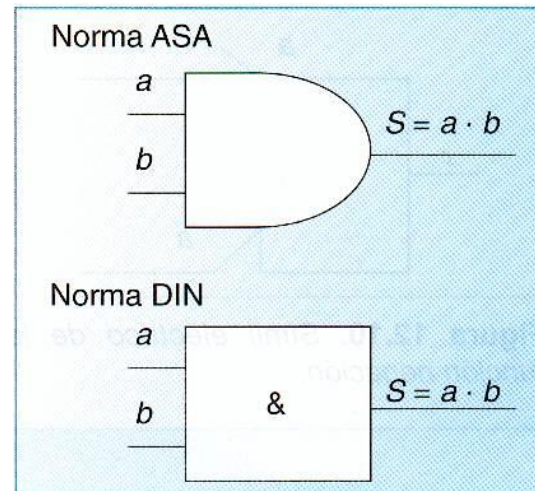
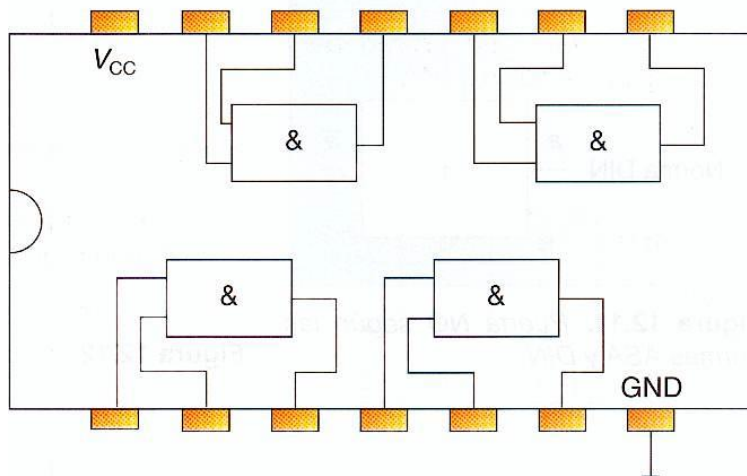

# FUNCIÓN NEGACIÓN: PORTA NOT

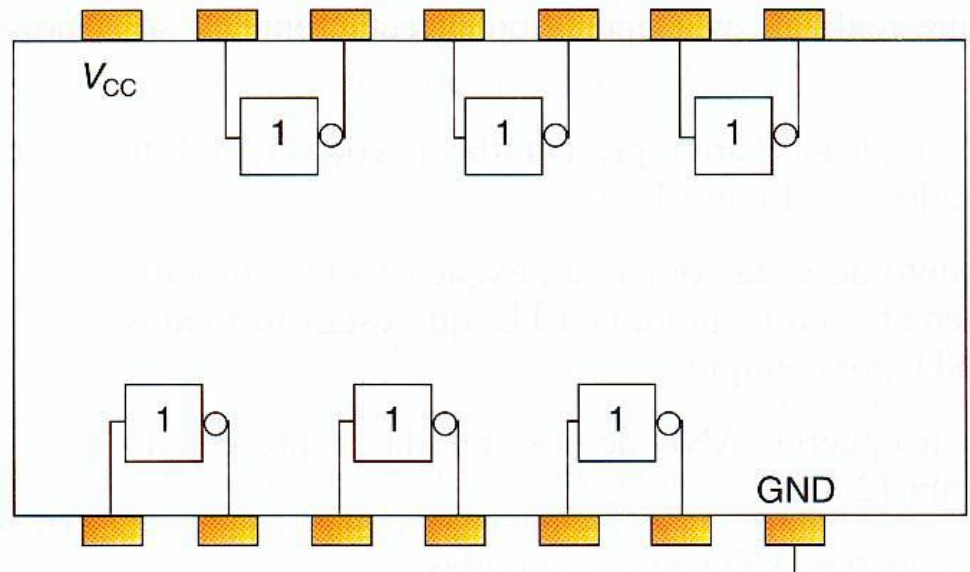
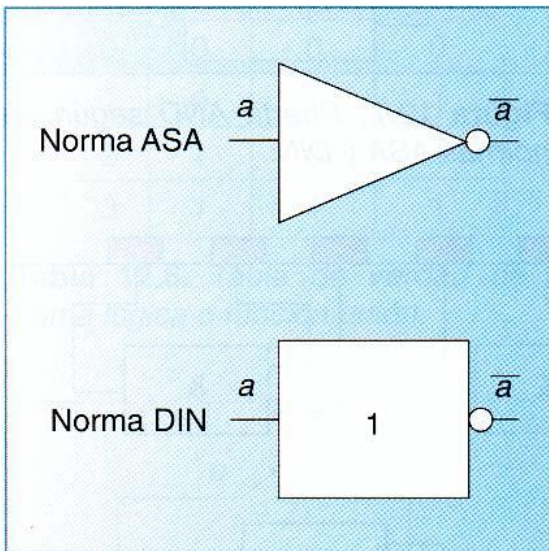

# FUNCIÓN OU PORTA NOR

	<i>b</i>	<i>a</i>	<i>S</i>
0	0	0	1
1	0	1	0
2	1	0	0
3	1	1	0

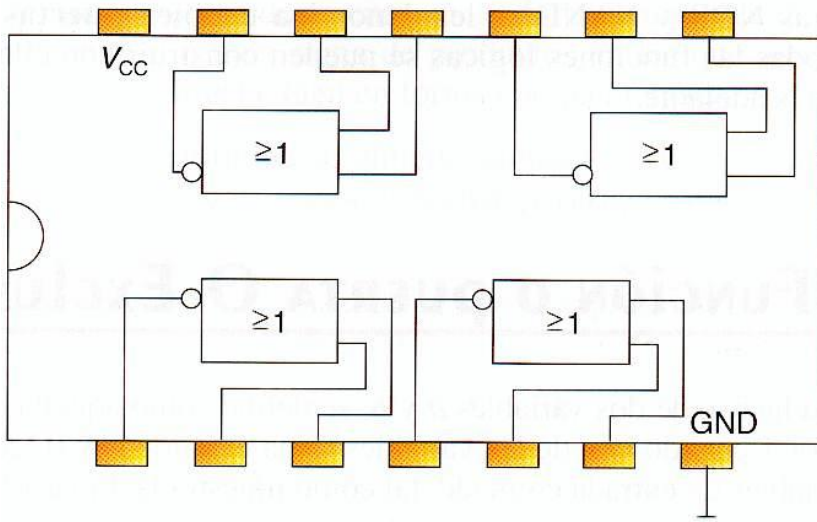

Norma ASA

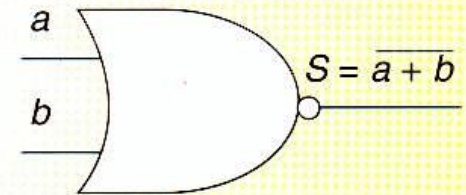

Norma DIN

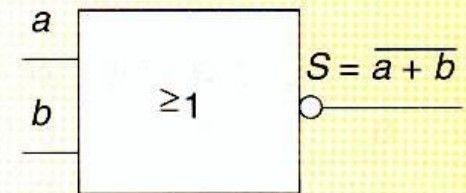



# FUNCIÓN OU PORTA NAND

	<i>b</i>	<i>a</i>	<i>S</i>
0	0	0	1
1	0	1	1
2	1	0	1
3	1	1	0

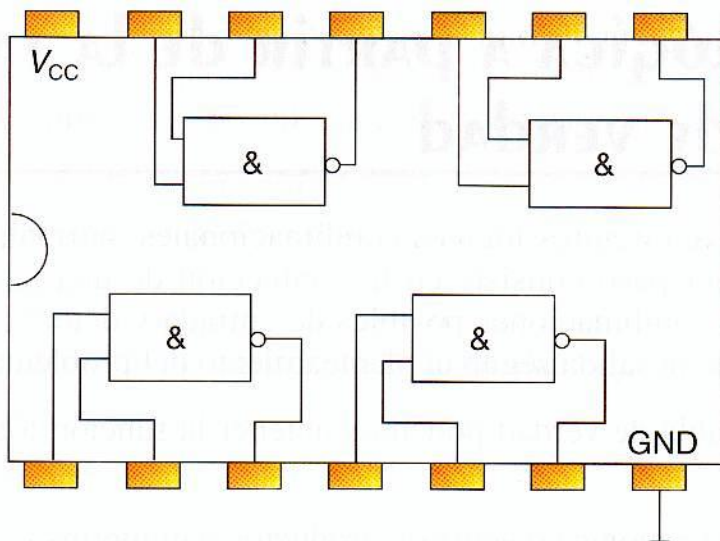

Norma ASA

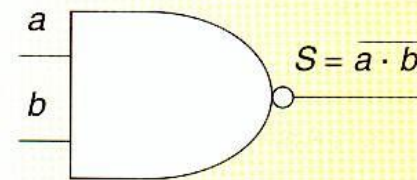

Norma DIN

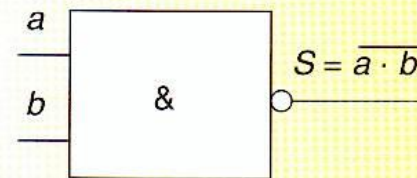

# FUNCIÓN O-EXCLUSIVA: PORTA XOR

	<i>b</i>	<i>a</i>	<i>S</i>
0	0	0	0
1	0	1	1
2	1	0	1
3	1	1	0

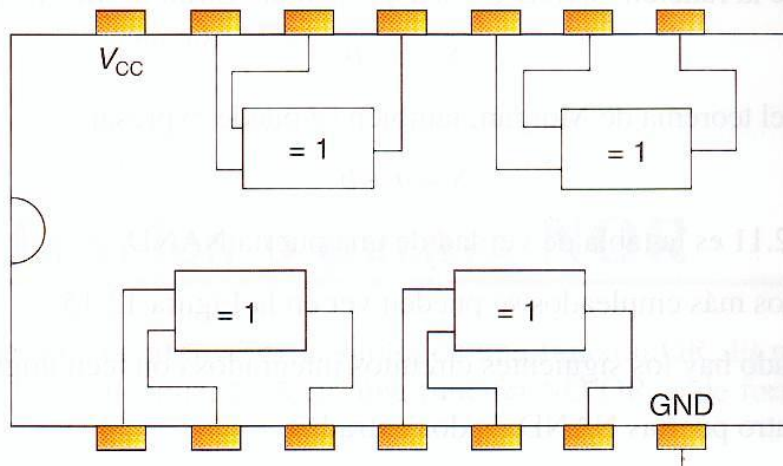

Norma ASA

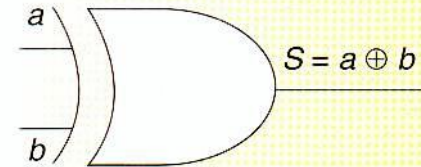

Norma DIN

