

Introducción al arte

Elementos formales

Materiales: Barro ((ladrillo o adobe)

Madera

Piedra (mármol, granito...)

Hierro, cemento, cristal

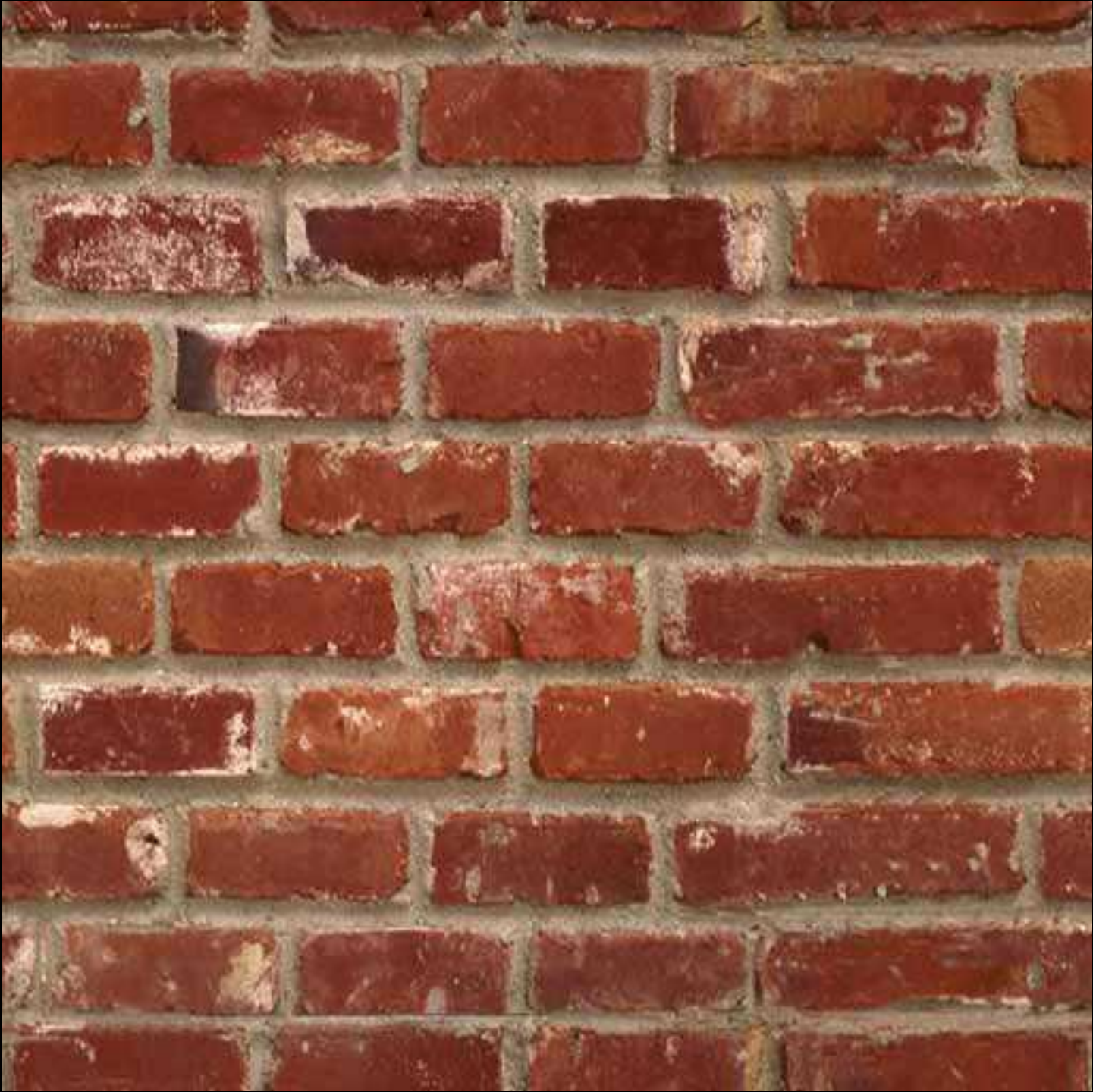

Ladrillo





La madera



O granito

O granito

19

20





Mármol

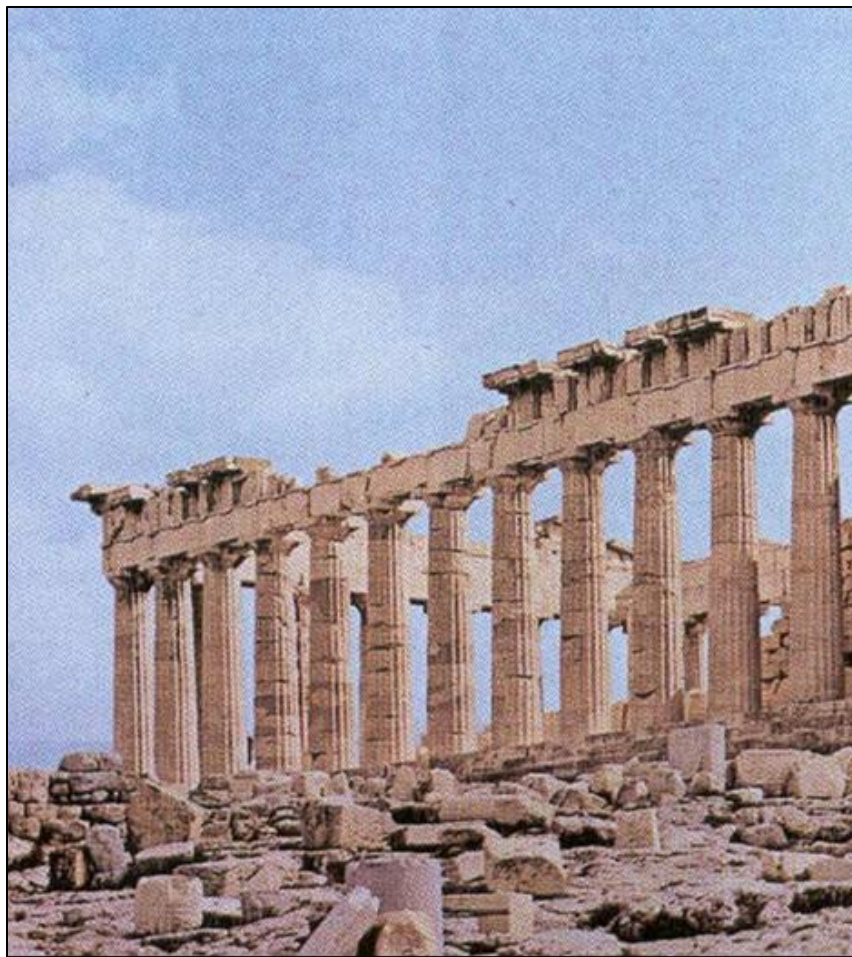

Hierro









Isodomo

Aparejo formado por sillares iguales.

El Sillar es un bloque de piedra labrado como un paralelepípedo

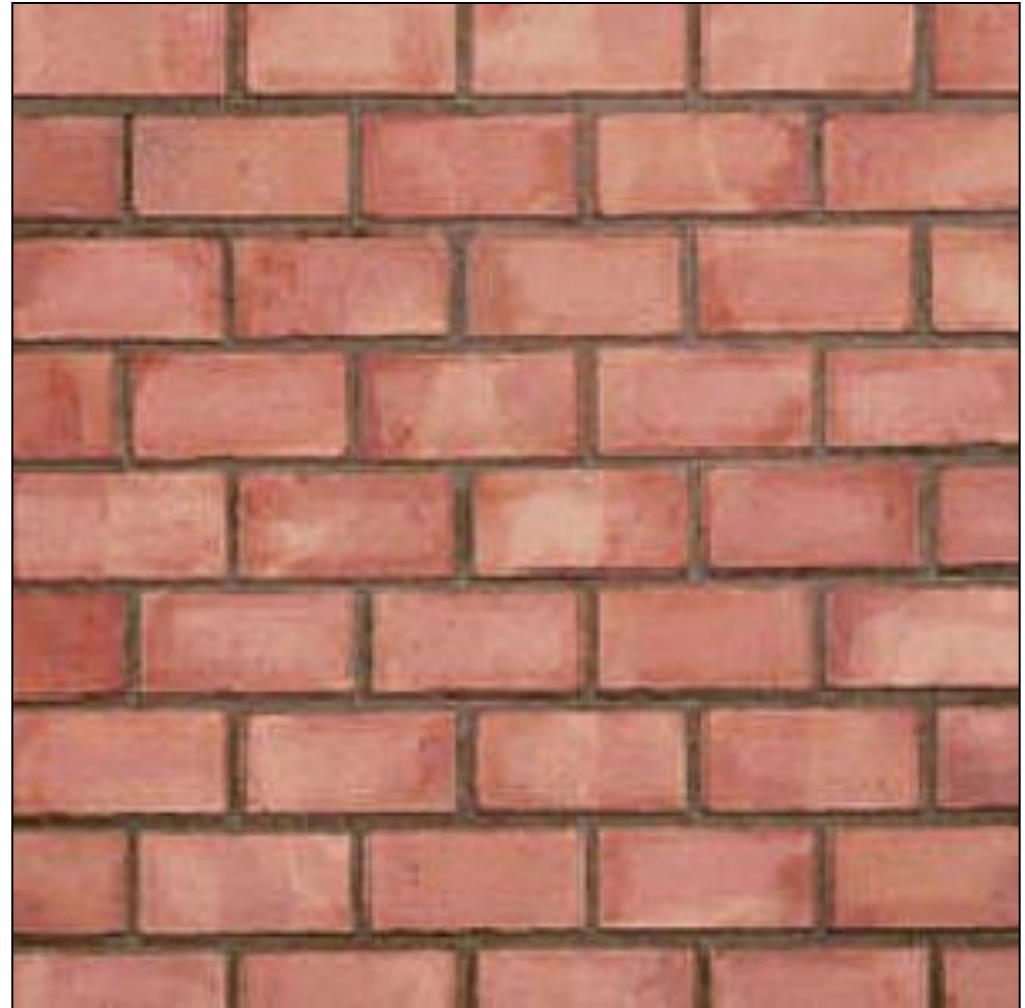
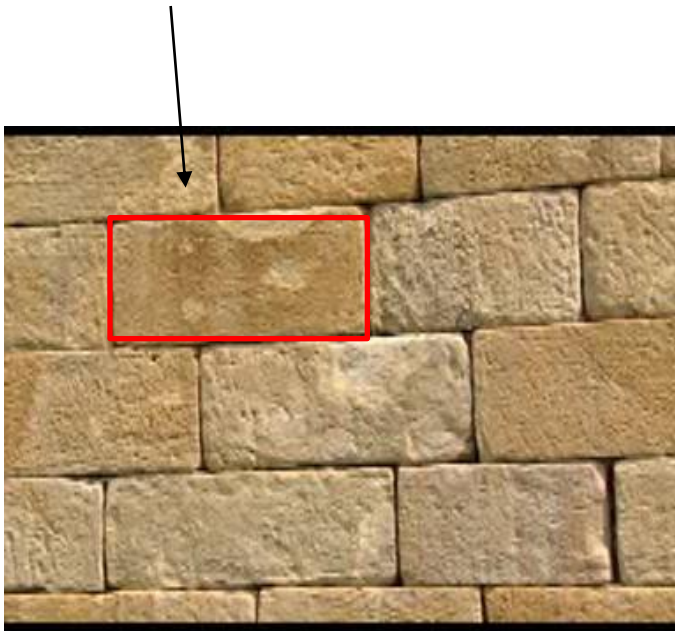

Mampostería

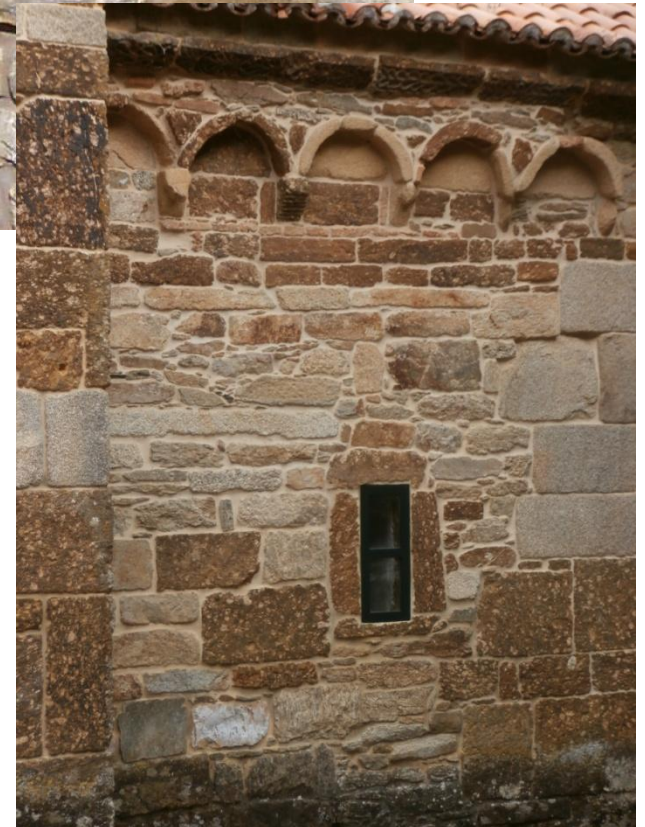

Vanos y puertas

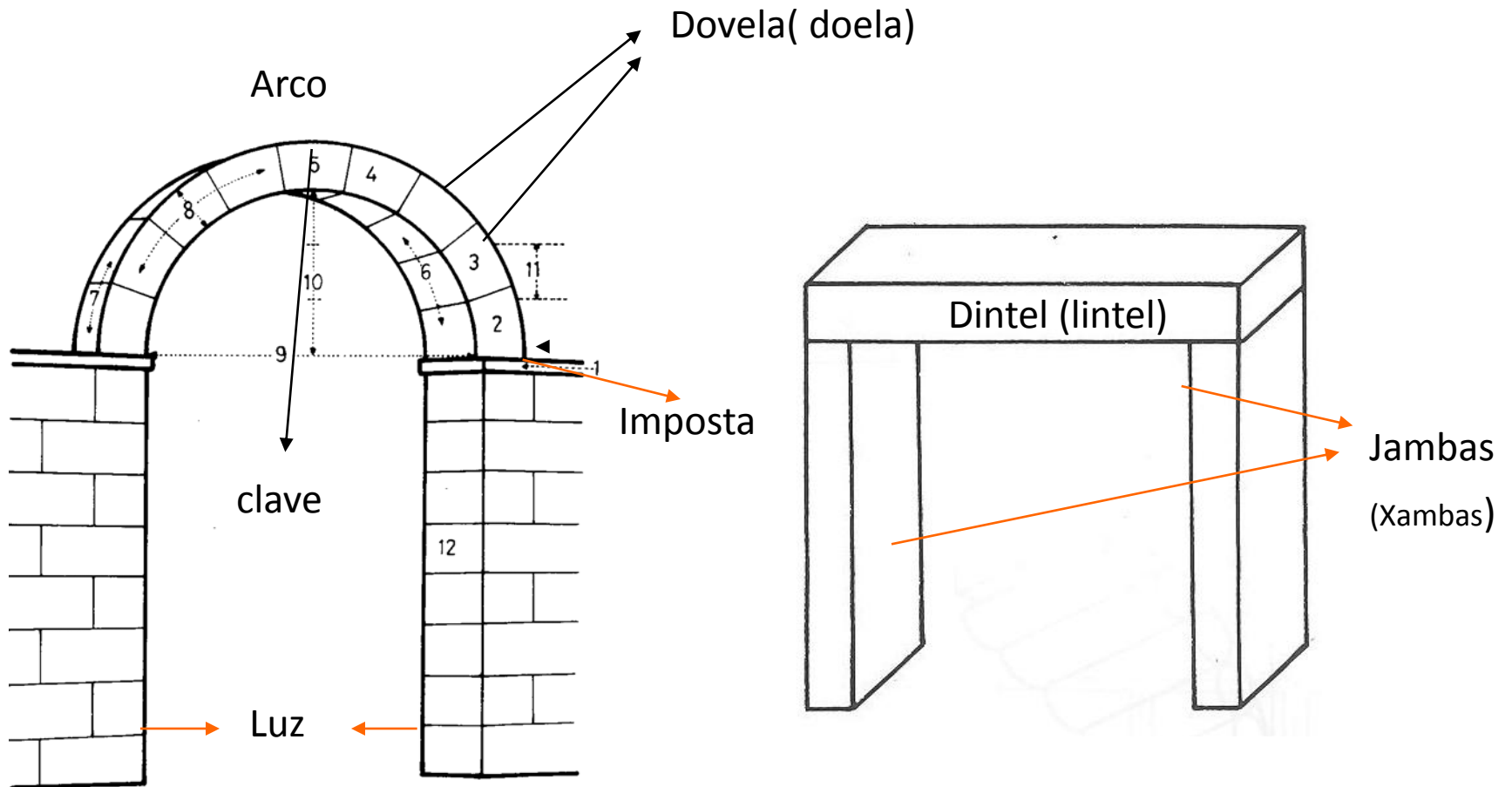

Arcos

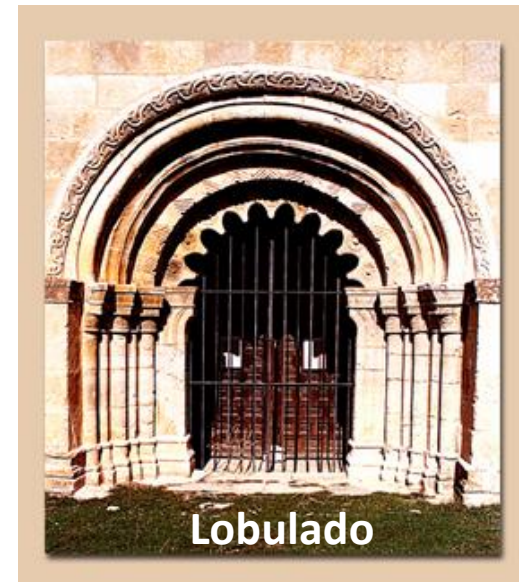
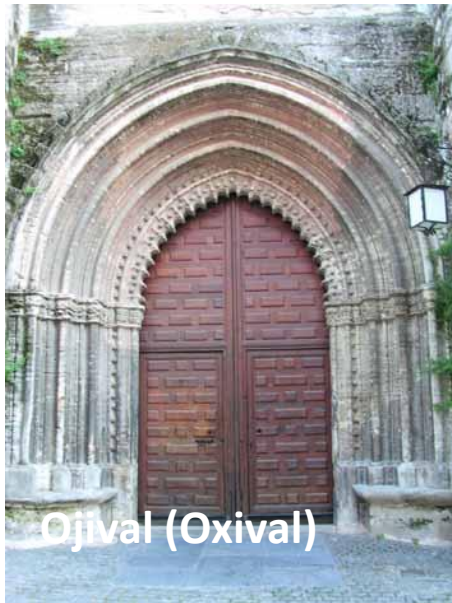

Arcos: función



Fajón (feixón)

Arco **formero** (formeiro)

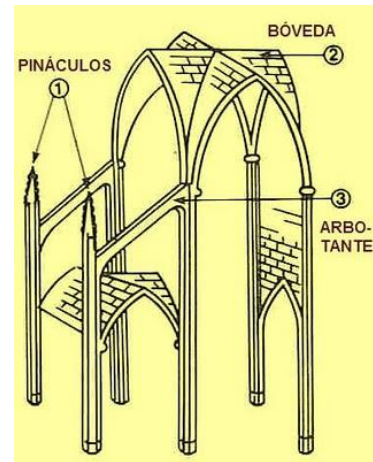

Soportes no continuos

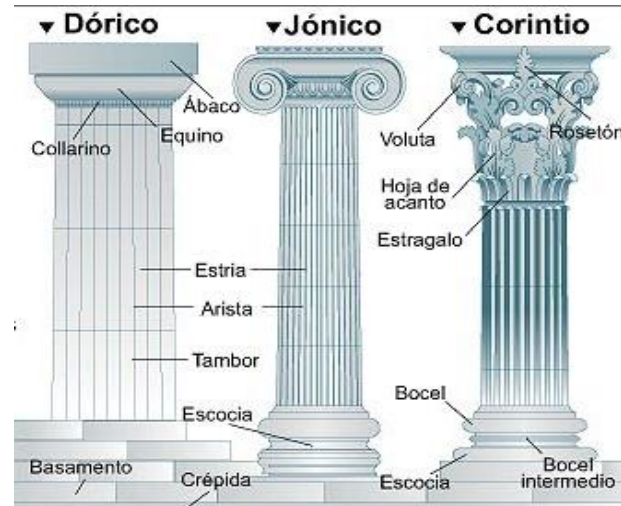

Planos

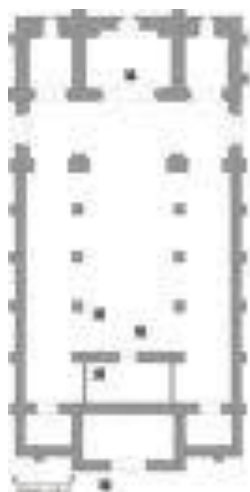

BASILICA DE
SANTA MARIA
(Oviedo)
S. IX
ICHO 812

PLANO

