

# First year of ENGLISH

Recomendacións para o repaso de vocabulario as fichas que adxunto, para a mellora a nivel auditiva podedes poñer os debuxos ou series que lles gusta en versión orixinal, xa que a televisión de hoxe en día deixan cambiar o idioma e así vanse acostumando a escoitar en inglés.

Vocabulario:

- Partes da casa: páxinas: 1 e 2.
- Partes do corpo: páxina: 7
- Familia: páxina: 8
- Animais: páxinas: 9
- Comida: páxina: 11

Páxinas web recomendables:

<https://arbolabc.com/juegos-de-ingles>

<https://global.cbeebies.com/>

<http://learnenglishkids.britishcouncil.org/>



Match and draw. Trace.

1   
bi

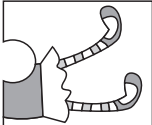
  
ll

2   
do

  
ll

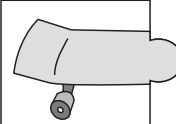
3   
skate

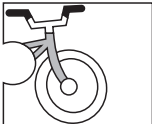
  
ke

4   
scoo

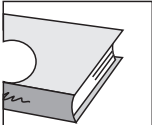
  
ok

5   
ba

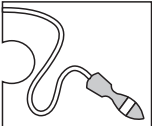
  
rope

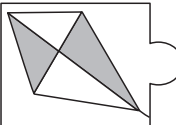
6   
ki

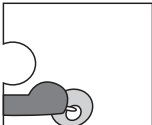
  
ter

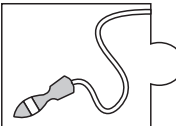
7   
skipping

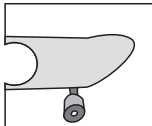
  
board

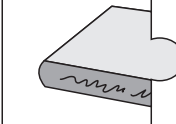
8   
bo

  
te

ball

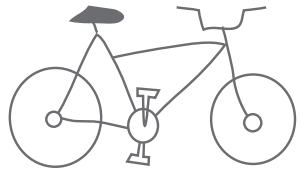
bike 

doll

scooter

book

skipping rope

kite

skateboard

Look, read and tick ✓.

1



ball

bike

big

small

2



scooter

doll

old

new

3



book

kite

big

small

4

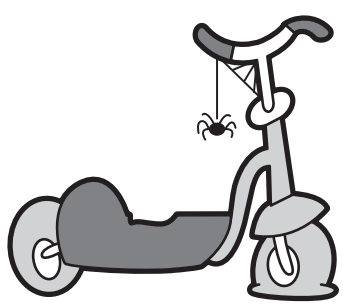

bike

scooter

old

new

Trace. Look, read and number.

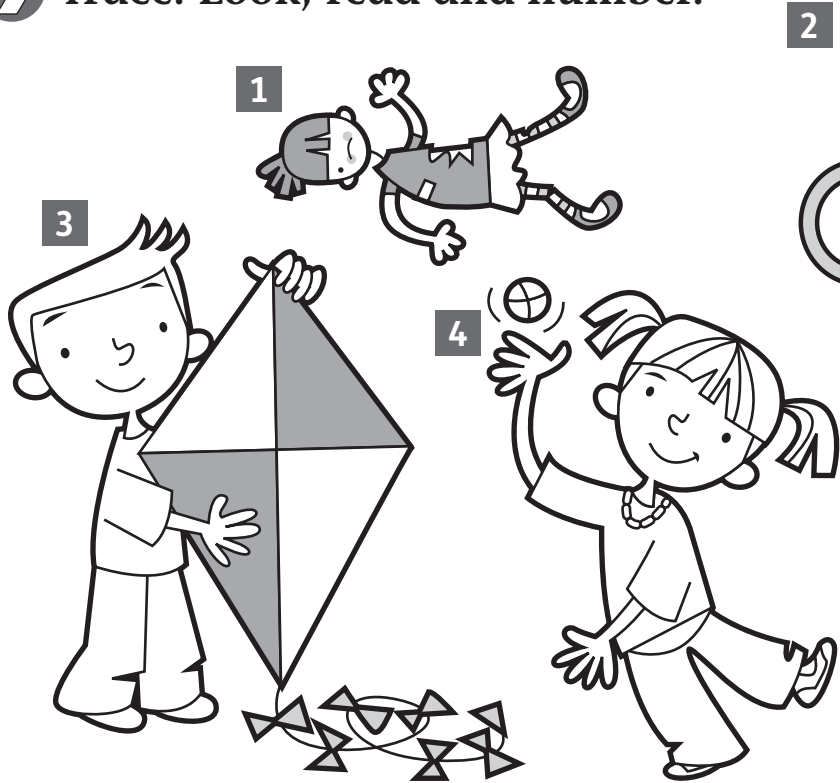

big



small



old

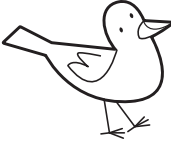

new





Follow and trace. Tick ✓ or cross ✗.

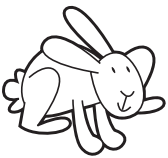

1   frog

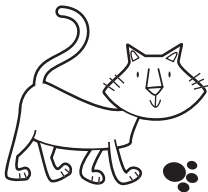
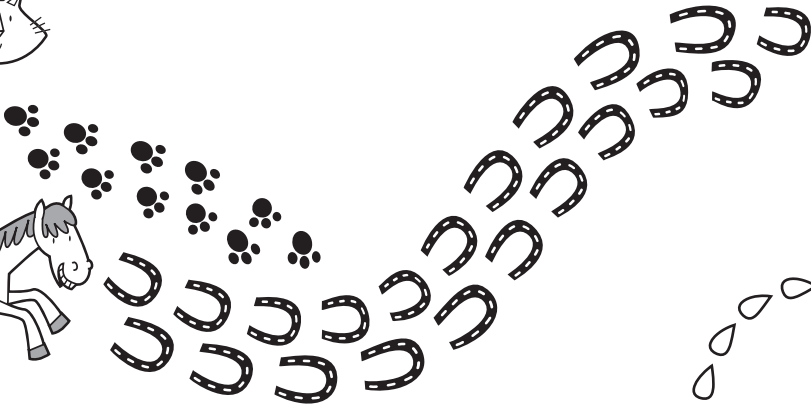

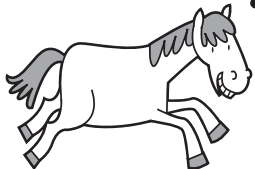
2   horse

3   bird

4   dog

5   fish

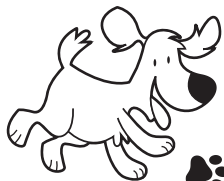
6   rabbit

7   mouse

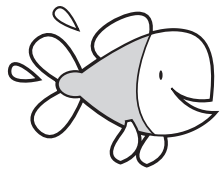
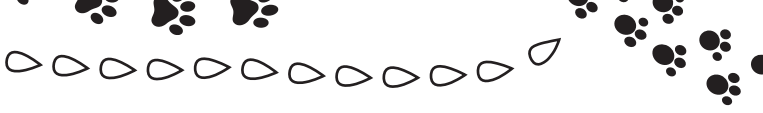
8   cat

➤ Look, read and tick ✓.

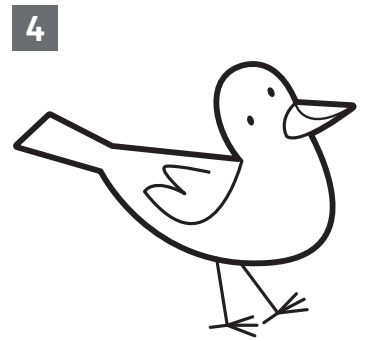
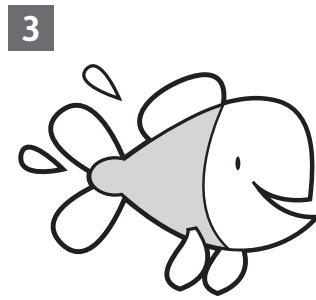
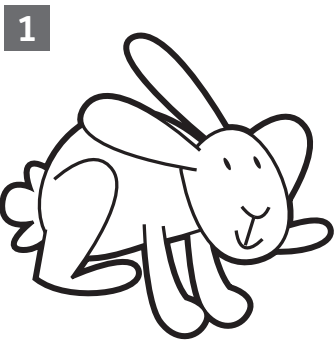

body   
 tail   
 nose   
 legs

body   
 tail   
 nose   
 legs

body   
 tail   
 nose   
 legs

body   
 tail   
 nose   
 legs

➤ Trace. Look and number.

body   
 legs   
 nose   
 tail

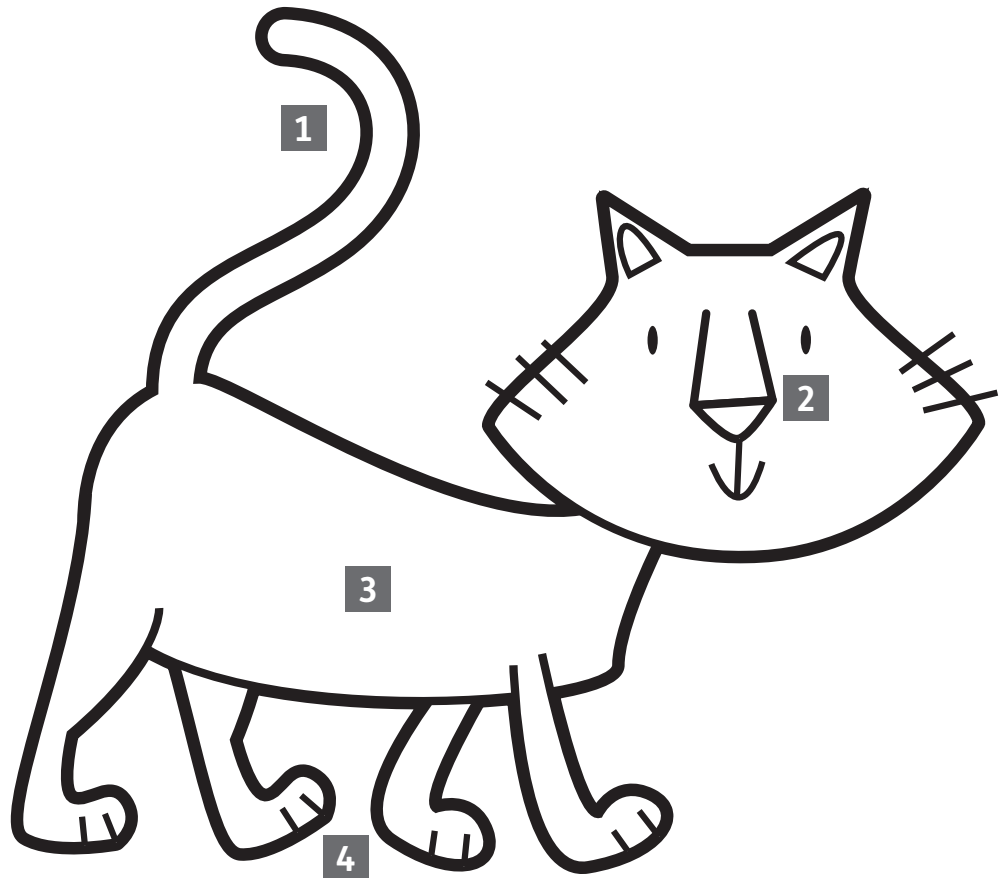

➤ Complete. ➤ Read and circle.

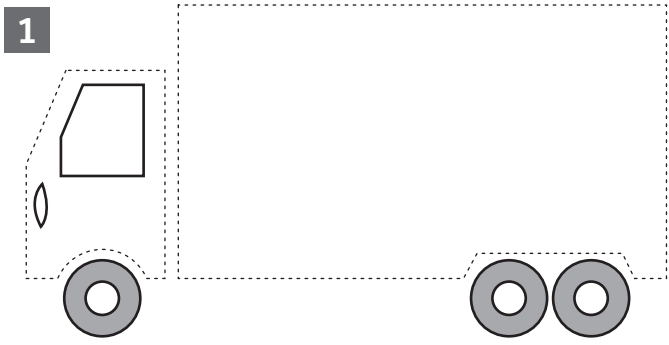

taxi lorry

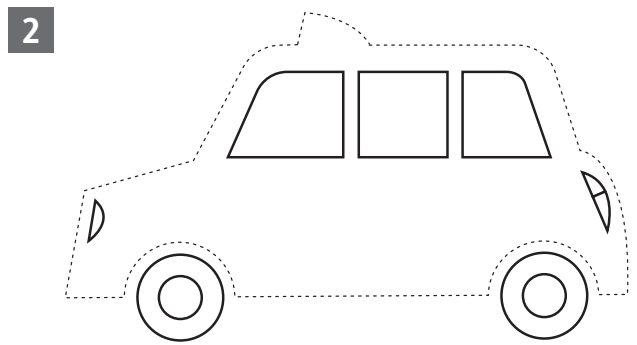

taxi train

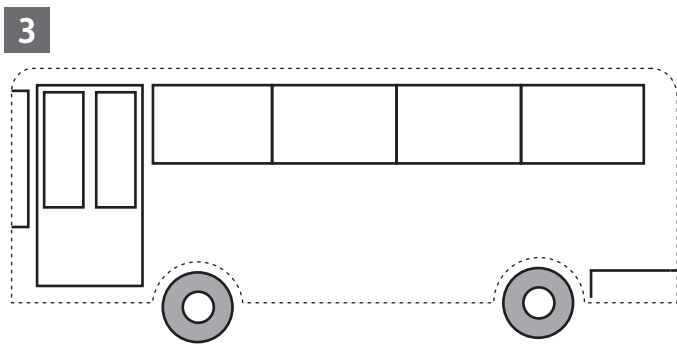

plane bus

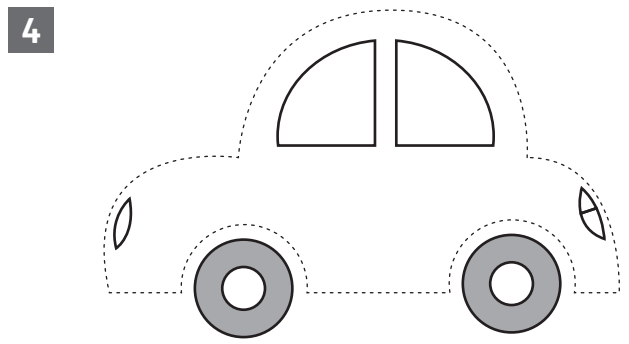

motorbike car

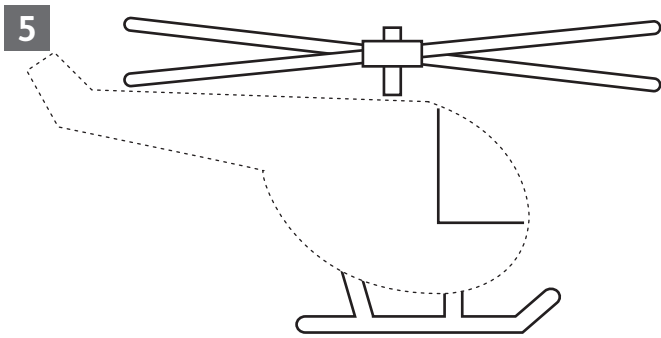

helicopter taxi

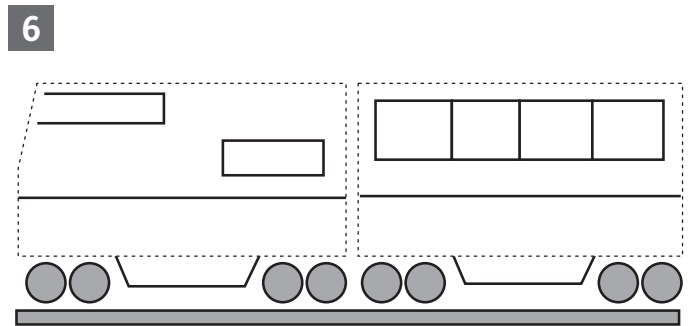

train lorry

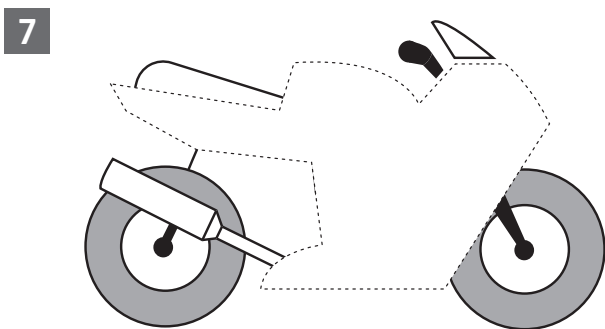

bus motorbike

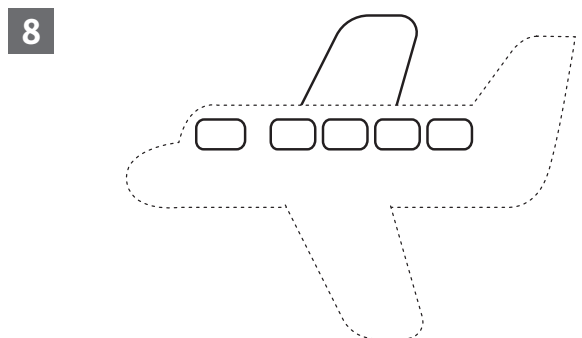

car plane

What's next? Match and write.

1



walk



eat



walk



eat



\_\_\_\_\_

2



run



shout



run



shout



\_\_\_\_\_

3



eat



eat



run



run



\_\_\_\_\_

4



walk



shout



run



walk



\_\_\_\_\_

Look and number.

1 brother

2 mum

3 grandma

4 dad

5 sister

6 grandpa

7 uncle

8 aunty

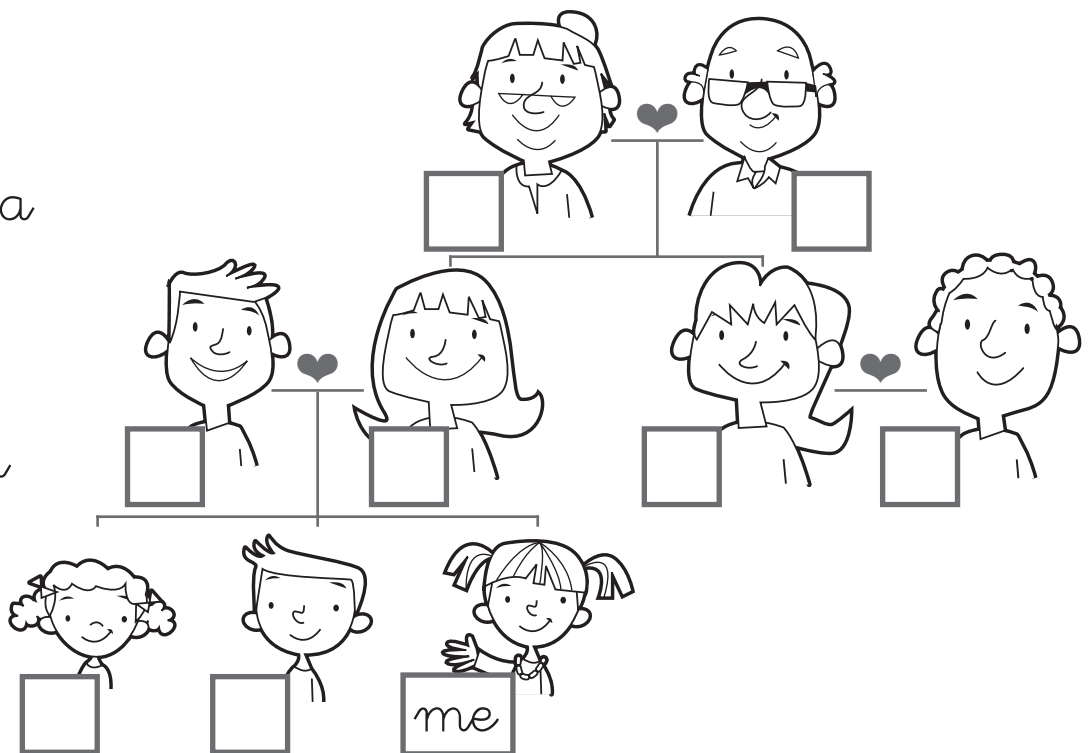

Write. Read and circle.



gr \_ ndm \_  
m \_ m

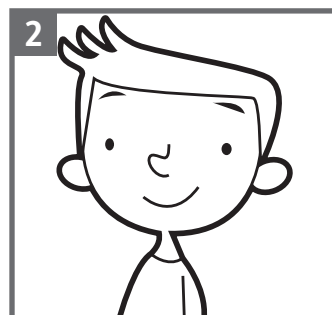

br \_ th \_ r  
s \_ st \_ r

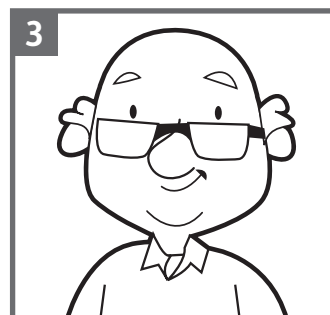

m \_ m  
gr \_ ndp \_

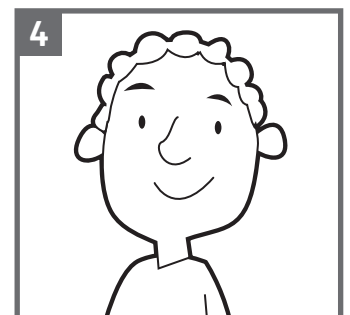

s \_ st \_ r  
\_ \_ ncl \_



d \_ d  
s \_ st \_ r

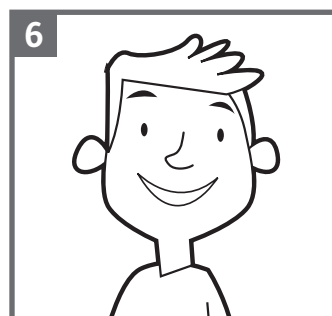

gr \_ ndm \_  
d \_ d



m \_ m  
br \_ th \_ r



\_ \_ nty  
d \_ d

➤ Match.

skip

jump

sing

dance



➤ Complete. ➤ Write.

1



He can \_\_\_\_\_.

2



She can \_\_\_\_\_.

3

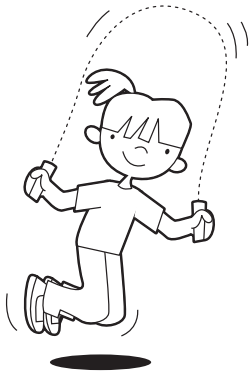

She can \_\_\_\_\_.

4



He can \_\_\_\_\_.

➤ Circle. ➤ Write.

T-shirt shoes jacket trousers skirt dress caps sunglasses

1   
T-shirt

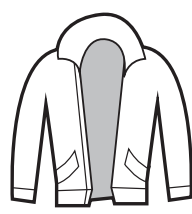
2 

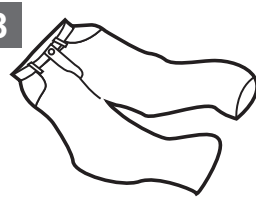
3 

4 

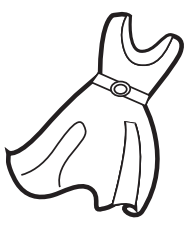
5 

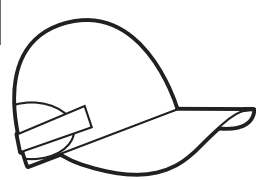
6 

7 

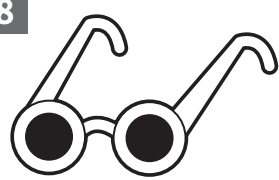
8 

➤ Look and write. ➤ Read and colour.

1 I'm wearing a blue  
jacket



2 I'm wearing green

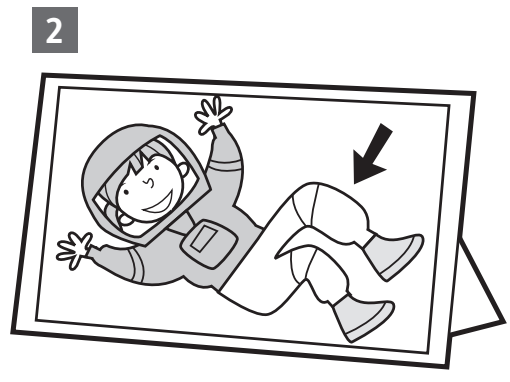

3 I'm wearing a red





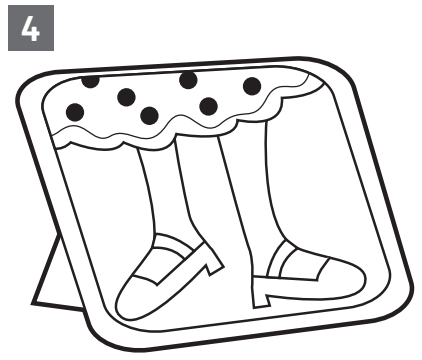

4 I'm wearing purple





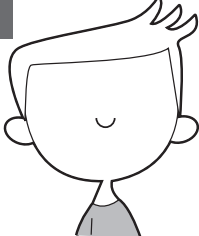
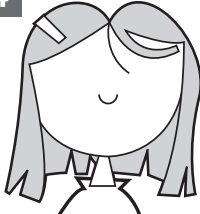
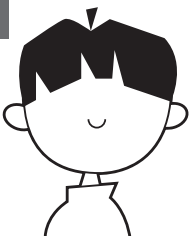

Follow and draw.

				
happy	sad	tired	hungry	thirsty

<b>1</b> 	<b>2</b> 	<b>3</b> 	<b>4</b> 	<b>5</b> 
				
thirsty	hungry	happy	tired	sad

Match and write.

1	happy	t i _ _ d	
2	thirsty	h a p p y	
3	tired	s _ d	
4	hungry	t _ _ _ _ t y	
5	sad	h _ _ _ _ y	



➤ Join and trace. ➤ Count and write.

1

*apples*

2

3

4

5

6

7

8

➤ Read and colour. ➤ Look and write. ➤ Draw 😊 or ☹ for you.

apples = green      olives = black  
 cherries = pink      oranges = orange  
 pears = yellow      grapes = purple  
 peaches = white      strawberries = red

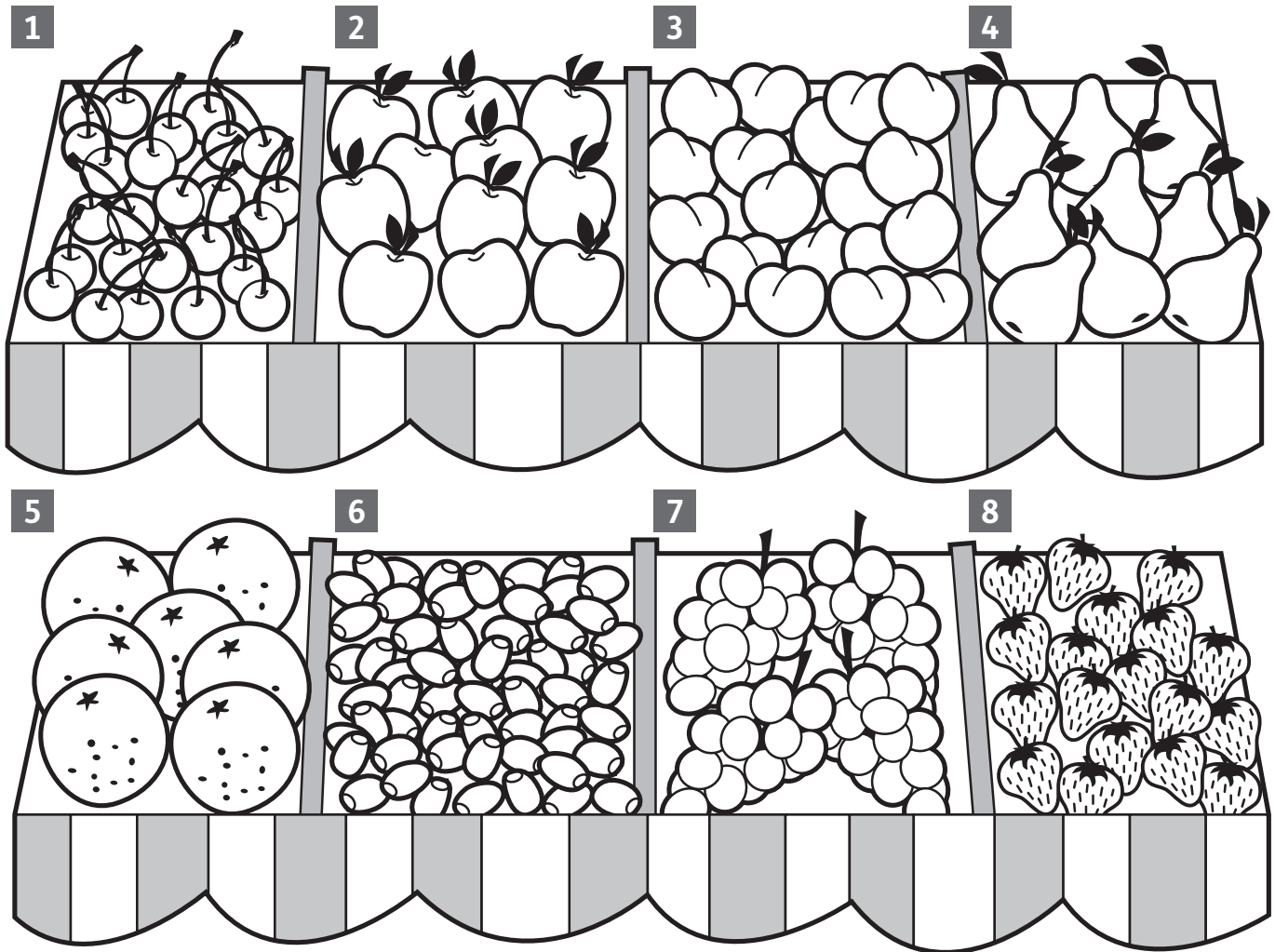

1 \_\_\_\_\_ 😐

2 \_\_\_\_\_ 😐

3 \_\_\_\_\_ 😐

4 \_\_\_\_\_ 😐

5 \_\_\_\_\_ 😐

6 \_\_\_\_\_ 😐

7 \_\_\_\_\_ 😐

8 \_\_\_\_\_ 😐

1

Look and draw. Write.

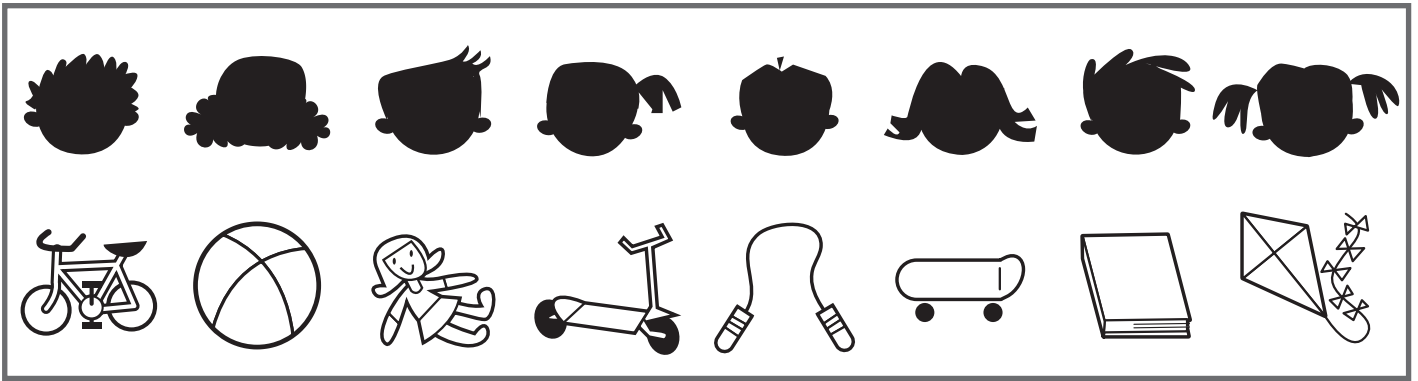

1

I've got a bike.

2

I've got a \_\_\_\_\_.

3

I've got a \_\_\_\_\_.

4

I've got a \_\_\_\_\_.

5

I've got a \_\_\_\_\_.

6

I've got a \_\_\_\_\_.

7

I've got a \_\_\_\_\_.

8

I've got a \_\_\_\_\_.

ball kite skateboard book bike  
skipping rope doll scooter

1

Follow and write.

ball book doll scooter  
big new old small

1



I've got a  
book.  
It's  
small.

2



I've got a  
\_\_\_\_\_.  
It's  
\_\_\_\_\_.

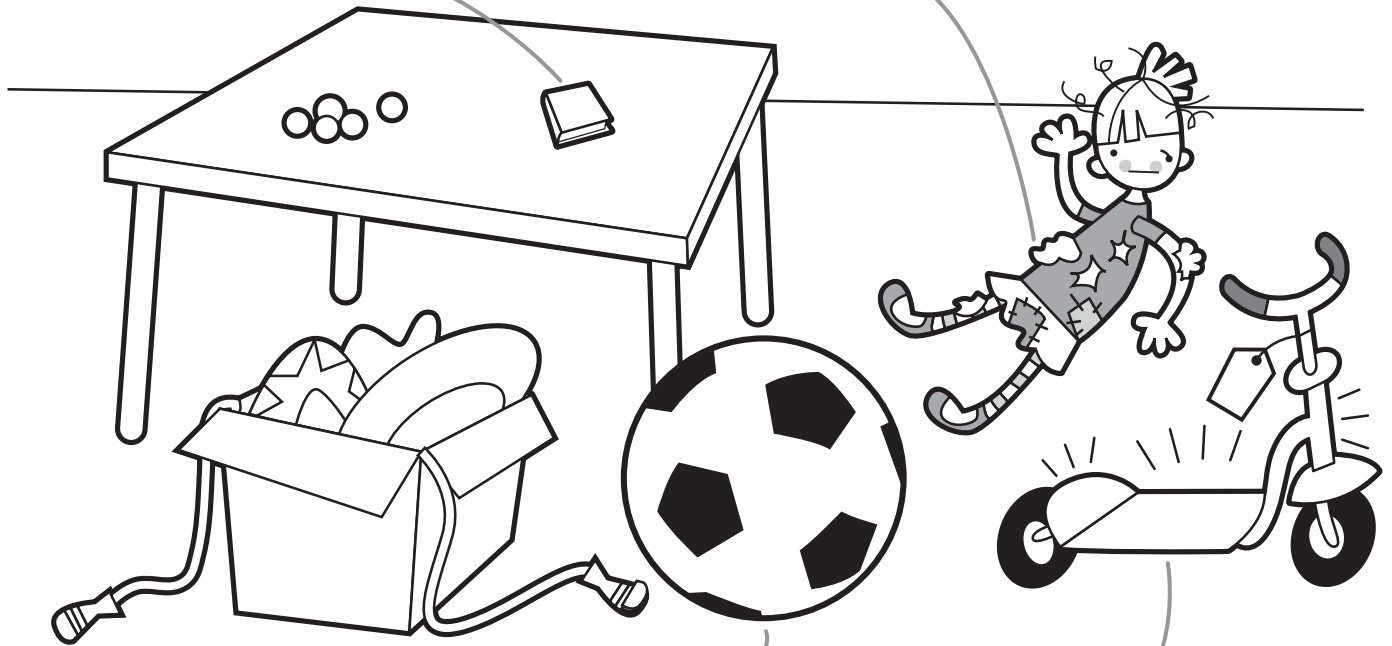

3



I've got a  
\_\_\_\_\_.  
It's  
\_\_\_\_\_.

4



I've got a  
\_\_\_\_\_.  
It's  
\_\_\_\_\_.

➤ Complete. ➤ Write.

bird cat dog fish frog  
~~horse~~ mouse rabbit

1

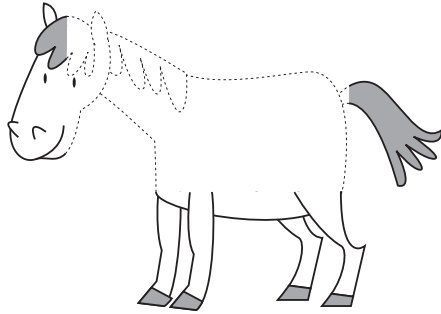

It's a horse.

2

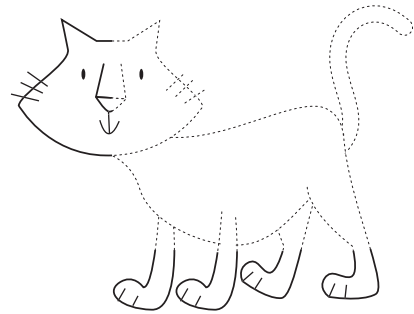

It's a \_\_\_\_\_.

3

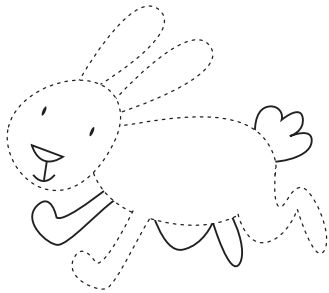

It's a \_\_\_\_\_.

4

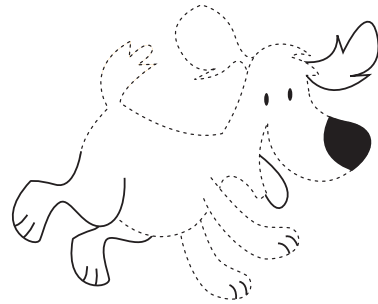

It's a \_\_\_\_\_.

5

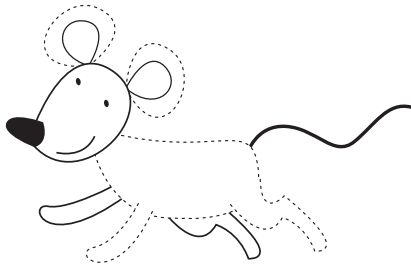

It's \_\_\_\_\_.

6

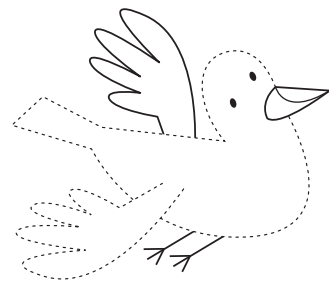

It's \_\_\_\_\_.

7

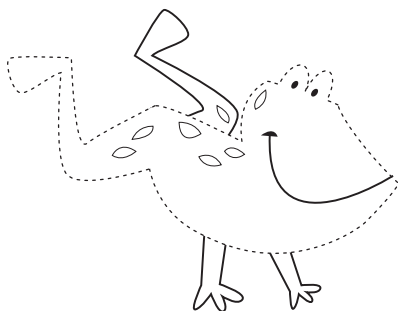

\_\_\_\_\_.

8

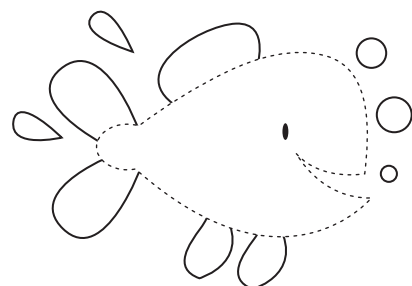

\_\_\_\_\_.

2

➤ Match and write. ➤ Read and colour.

1

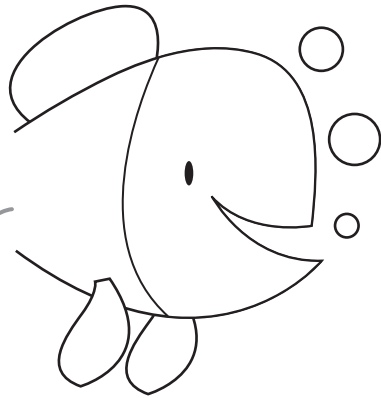

It's a fish.

Look! A blue tail.

2

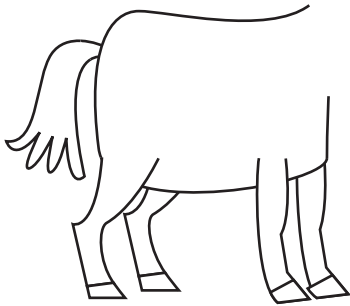

It's a \_\_\_\_\_.

Look! A brown body.

3

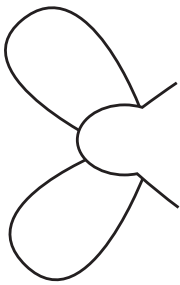

It's a \_\_\_\_\_.

Look! Green legs.

4



\_\_\_\_\_  
\_\_\_\_\_  
Look! A pink nose.

➤ Look and write.

bus car helicopter lorry  
motorbike plane taxi train

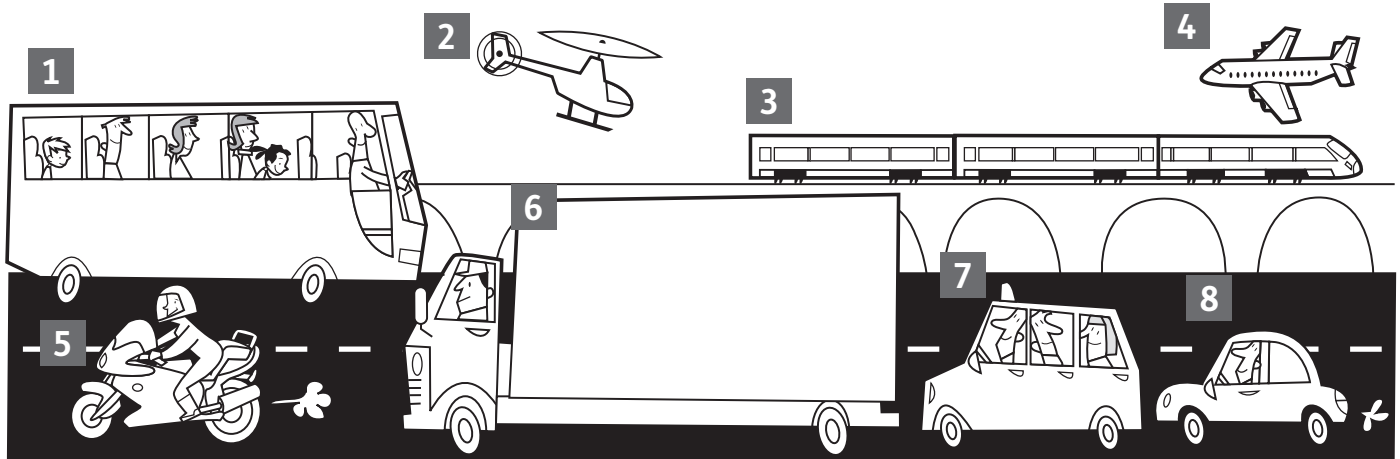

1 \_\_\_\_\_

5 \_\_\_\_\_

2 \_\_\_\_\_

6 \_\_\_\_\_

3 \_\_\_\_\_

7 \_\_\_\_\_

4 \_\_\_\_\_

8 \_\_\_\_\_

➤ Look and colour. ➤ Write.

■ = red   ● = green   ▲ = blue   ◆ = orange

1 I can see a  
\_\_\_\_\_ bus \_\_\_\_\_.

It's □ \_\_\_\_\_ red \_\_\_\_\_.

2 I can see a  
\_\_\_\_\_ \_\_\_\_\_.

It's ◆ \_\_\_\_\_.

3 I can see a  
\_\_\_\_\_ \_\_\_\_\_.

It's ▲ \_\_\_\_\_.

4 I can see a  
\_\_\_\_\_ \_\_\_\_\_.

It's ○ \_\_\_\_\_.

➤ Read and match.

1 Walk!

2 Run!

3 Eat!

4 Shout!

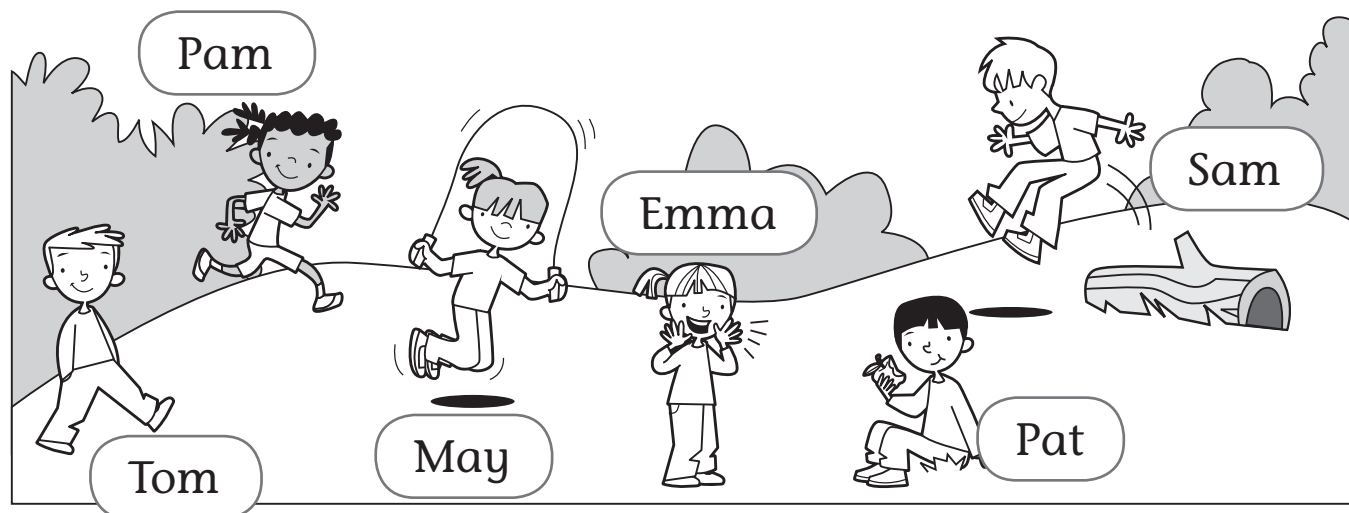

➤ Write, match and number.

ou a Ea u e

1 W \_ l k!

2 Don't r \_ n!

3 Don't \_ at!

4 Don't sh \_ \_ t!

5 \_ \_ t!

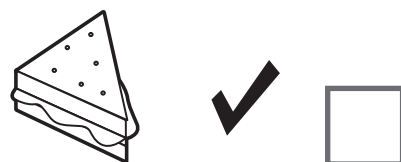
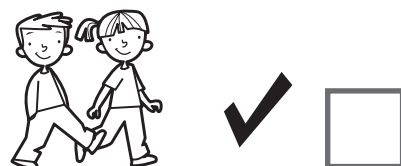
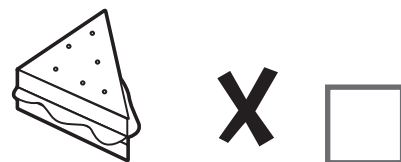



➤ Look and write.

grandma mum dad aunty brother  
uncle sister grandpa

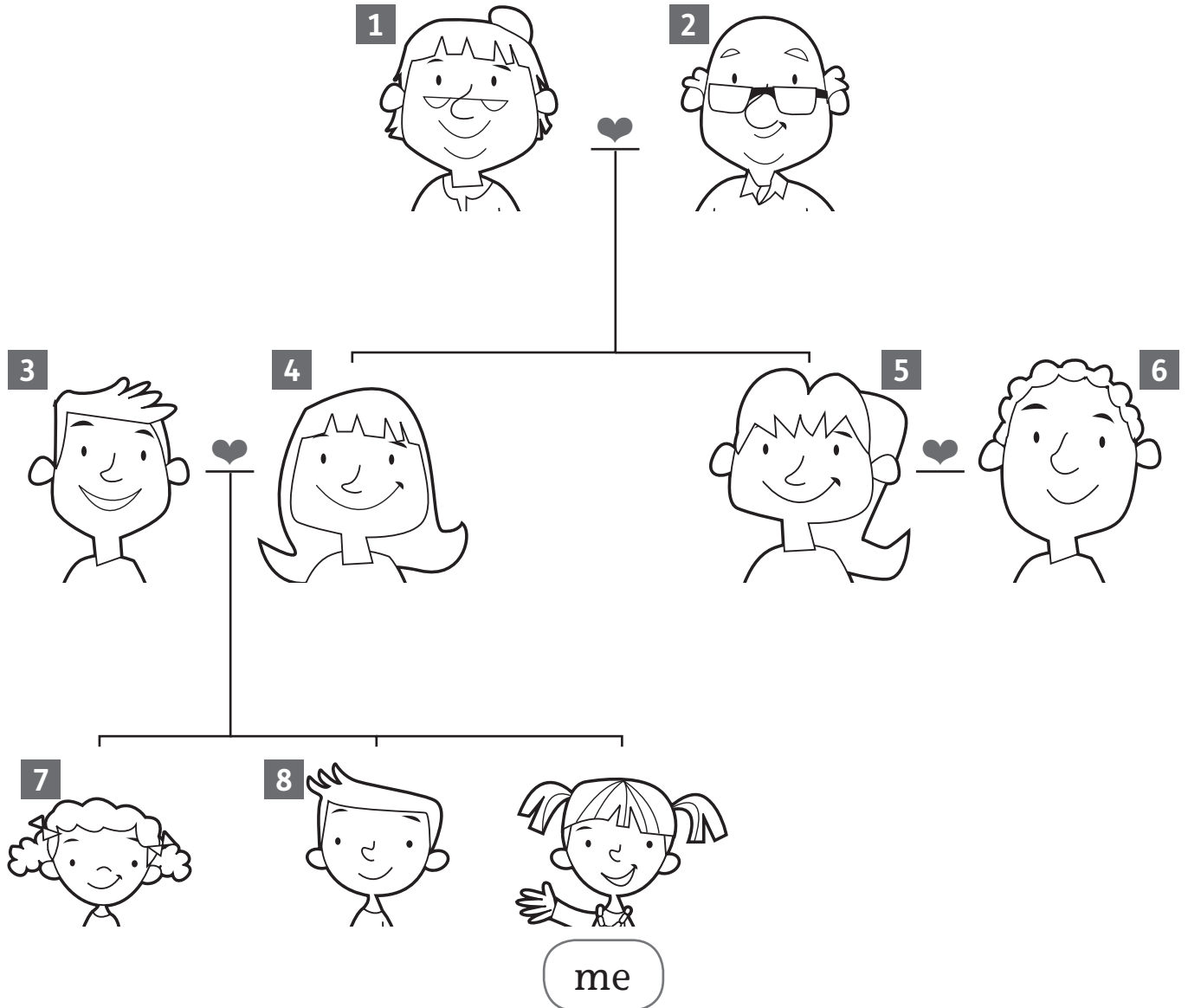

- 1 This is my grandma.      5 This is my \_\_\_\_\_.
- 2 This is my \_\_\_\_\_.
- 3 This is my \_\_\_\_\_.
- 4 This is my \_\_\_\_\_.
- 6 This is my \_\_\_\_\_.
- 7 This is \_\_\_\_\_.
- 8 \_\_\_\_\_.



Write.

cap dress jacket shoes skirt  
 sunglasses trousers T-shirt

1 skirt \_\_\_\_\_

2 \_\_\_\_\_

3 \_\_\_\_\_

4 \_\_\_\_\_

5 \_\_\_\_\_

6 \_\_\_\_\_

7 \_\_\_\_\_

8 \_\_\_\_\_

Look and write. Draw and write for you.

I'm wearing a dress and \_\_\_\_\_.

I'm wearing a \_\_\_\_\_ and \_\_\_\_\_.

I'm wearing \_\_\_\_\_.

Write and match.

happy hungry sad thirsty tired

1 She's s \_ \_ d.



2 She's t \_ \_ r \_ \_ d.



3 She's h \_ \_ ngr \_ \_.



4 He's h \_ \_ ngr \_ \_.



5 She's h \_ \_ pp \_ \_.



6 He's t \_ \_ r \_ \_ d.



7 He's th \_ \_ rst \_ \_.



8 She's th \_ \_ rst \_ \_.



➤ Look, circle and write.

apples cakes eggs olives sandwiches  
sausages strawberries tomatoes

1

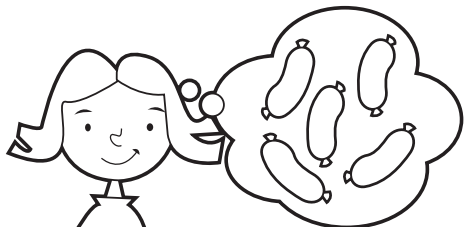

I like / don't like sausages.

2

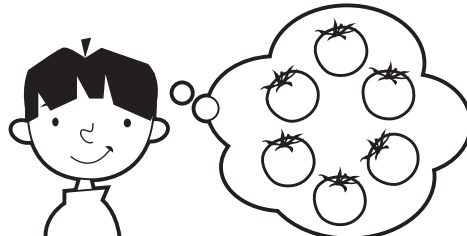

I like / don't like \_\_\_\_\_.

3



I like / don't like \_\_\_\_\_.

4



I like / don't like \_\_\_\_\_.

5

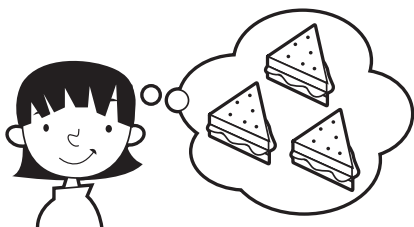

I like / don't like \_\_\_\_\_.

6



I like / don't like \_\_\_\_\_.

7

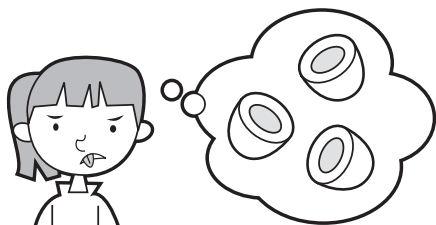

I like / don't like \_\_\_\_\_.

8

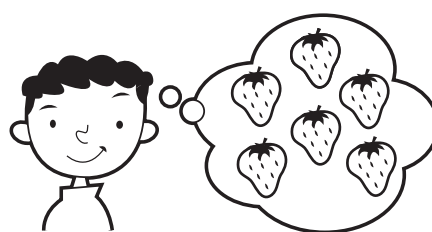

I like / don't like \_\_\_\_\_.

➤ Count and colour.

3 = yellow    4 = green    5 = brown    6 = red

Follow and write. Follow, draw and write for you.

cakes cherries grapes olives  
oranges peaches

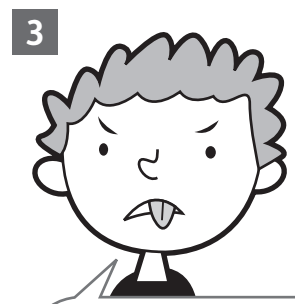
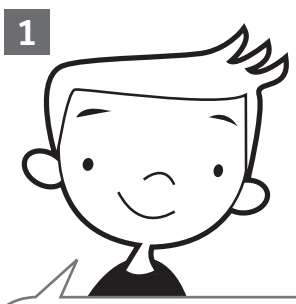

I like  
cakes.

I don't like  
\_\_\_\_\_.

I  
\_\_\_\_\_.

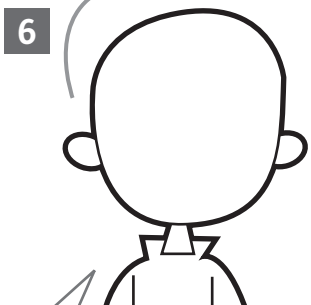
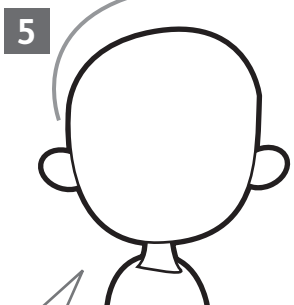
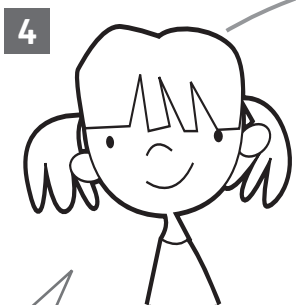
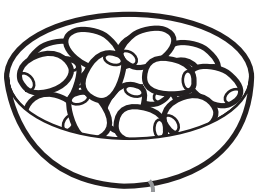
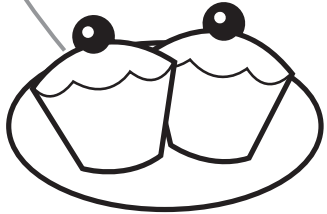
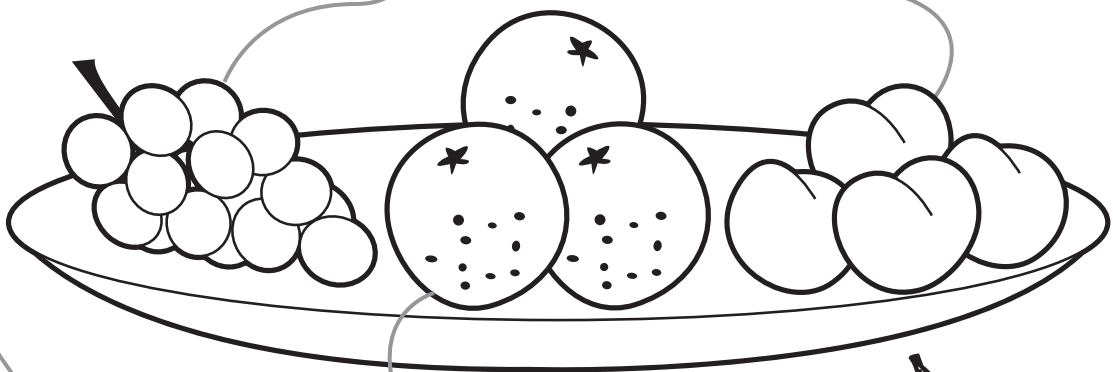

\_\_\_\_\_  
\_\_\_\_\_.

\_\_\_\_\_  
\_\_\_\_\_.

\_\_\_\_\_  
\_\_\_\_\_.

➤ Match and trace.

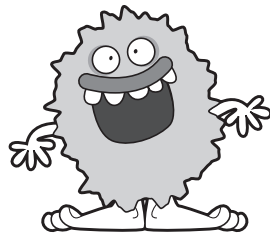
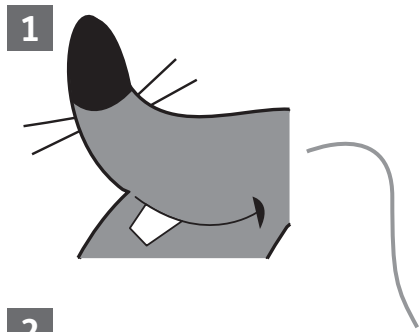

*witch*

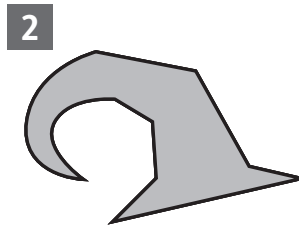

*rat*

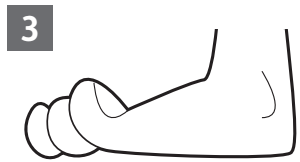

*ghost*

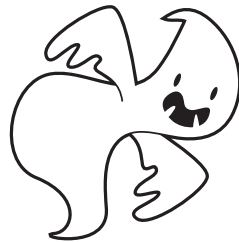
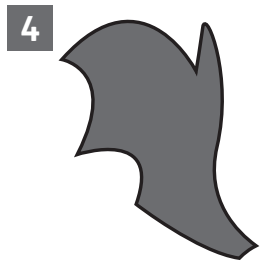

*bat*

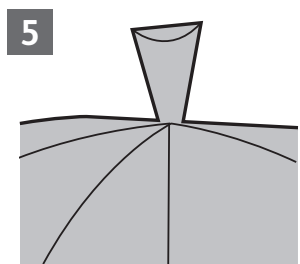

*pumpkin*

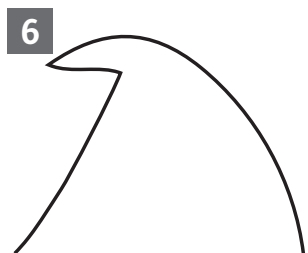

*monster*

➤ Trace, count and write.



1 carrot

2 mince pie

3 present

4 star

5 stocking

6 tree



➤ Look, number and write.

bat ghost monster pumpkin rat witch

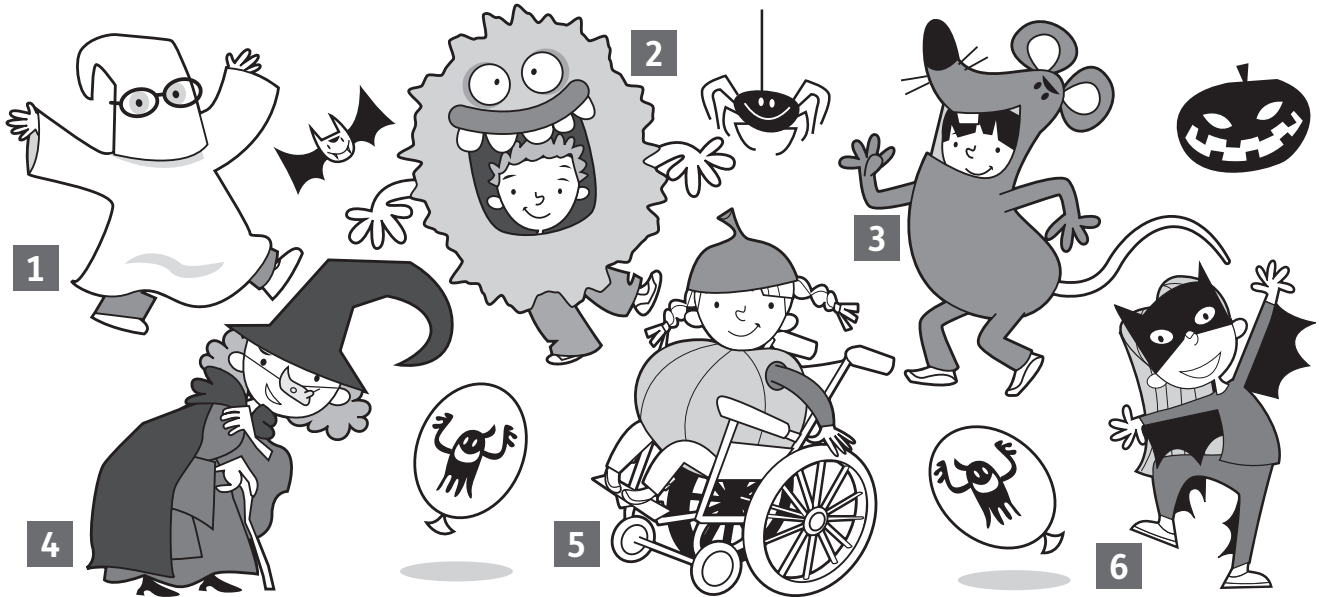

I'm a \_\_\_\_\_.

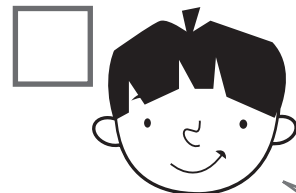

I'm a \_\_\_\_\_.

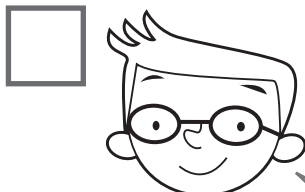

I'm a \_\_\_\_\_.

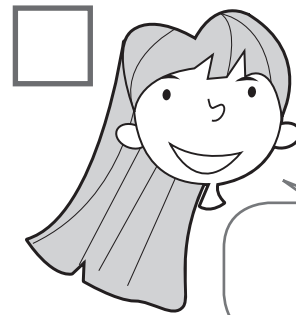

I'm a \_\_\_\_\_.



I'm a \_\_\_\_\_.

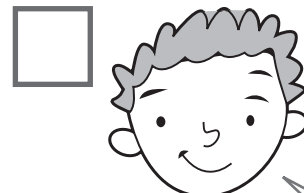

I'm a \_\_\_\_\_.

➤ Colour the key. ➤ Look and colour. ➤ Look and write.

1 = orange    2 = brown    3 = yellow  
 4 = green    5 = red    6 = blue

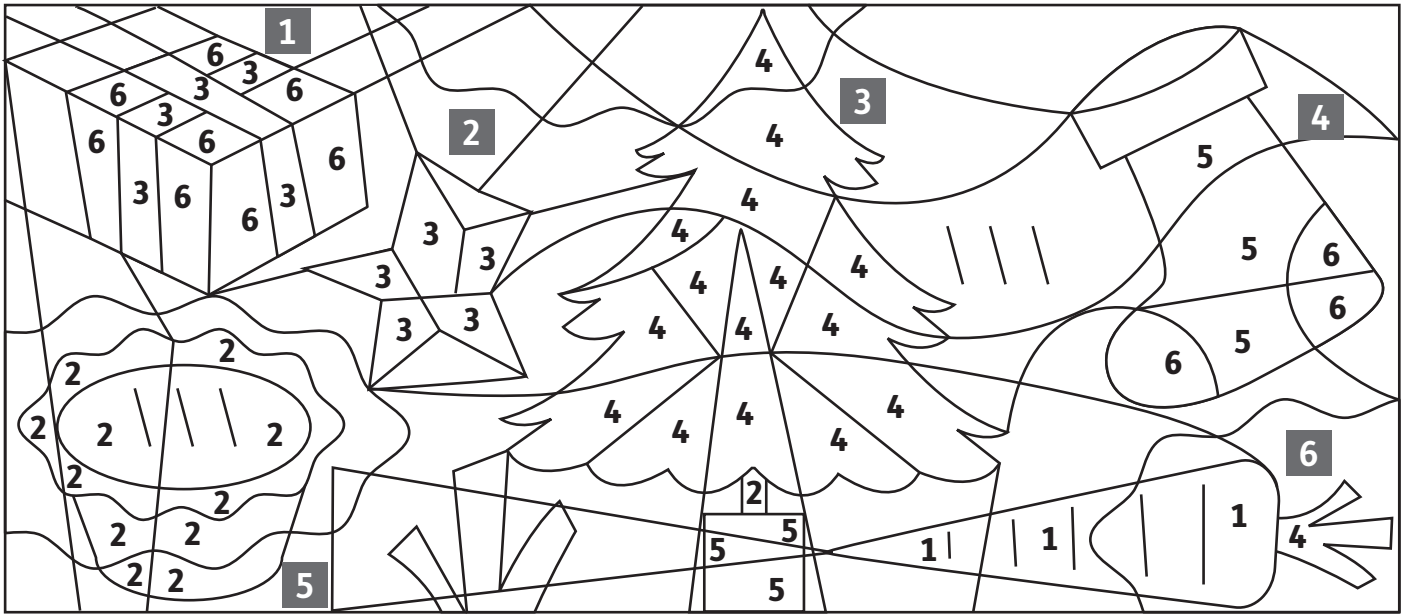

- |                 |               |
|-----------------|---------------|
| 1 It's a _____. | 4 It's _____. |
| 2 It's a _____. | 5 _____.      |
| 3 It's a _____. | _____.        |
| _____.          | 6 _____.      |

carrot    mince pie    present  
 star    stocking    tree

 Make a monster mask.

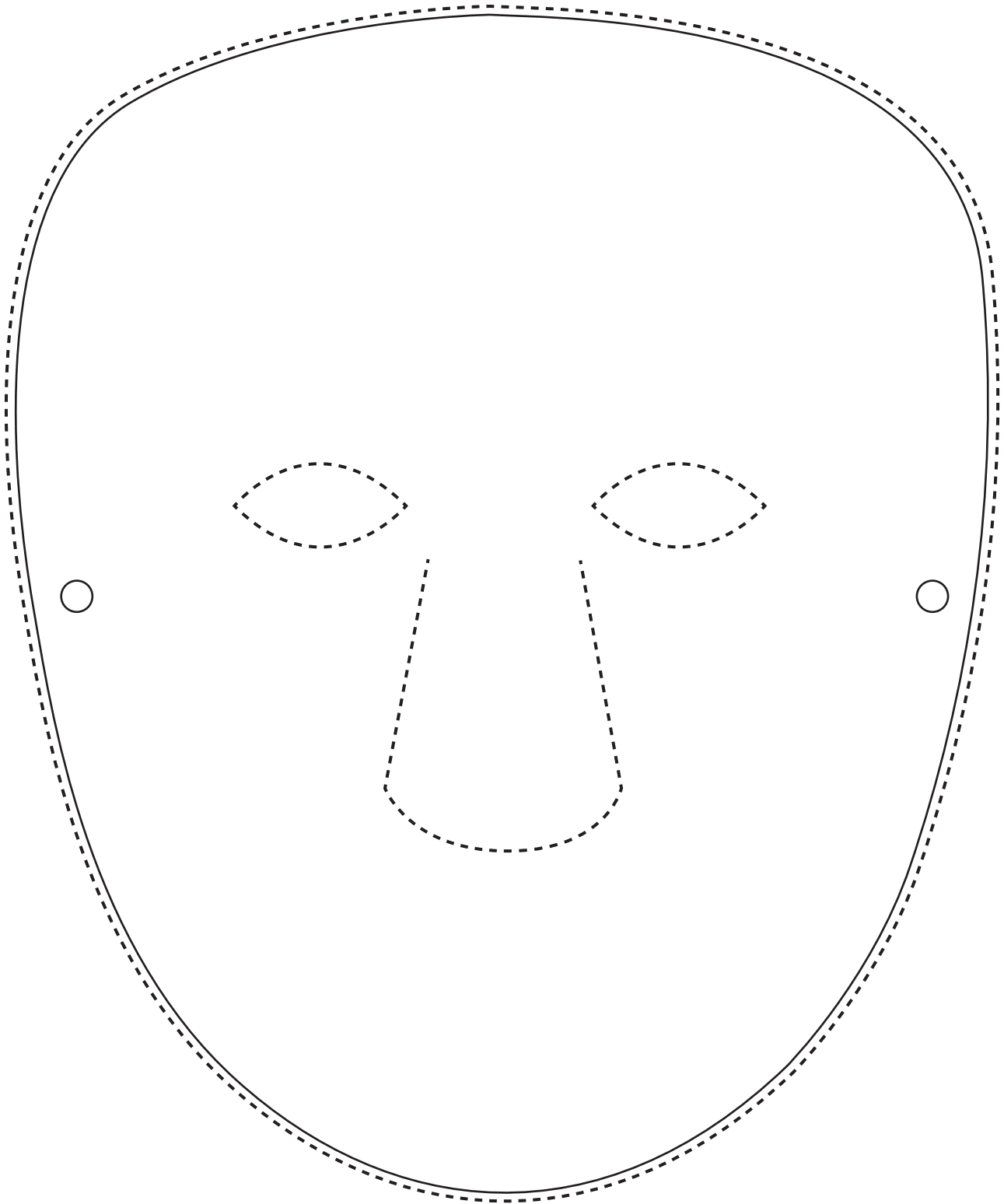

 Make a Christmas star.

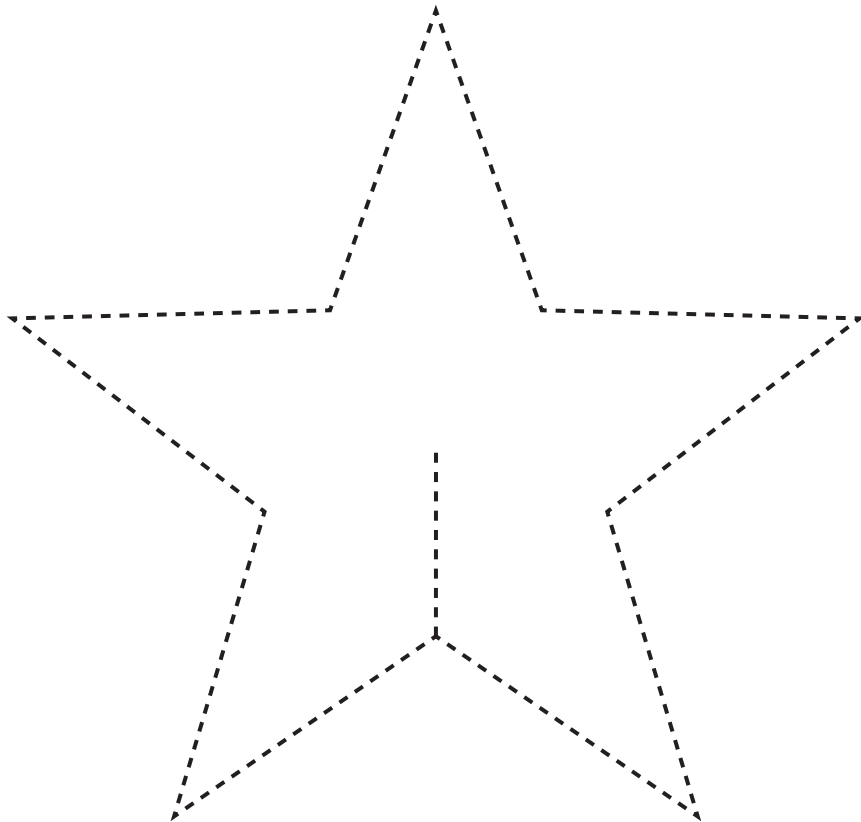
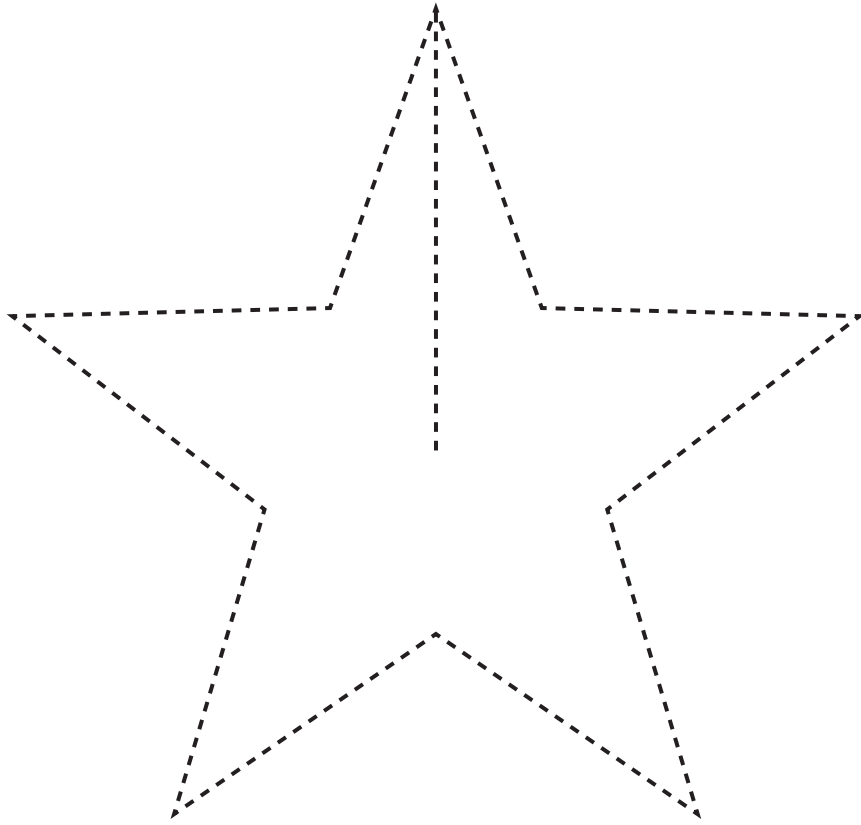

# Teaching notes

## Reinforcement

### Unit 1 Reinforcement 1

#### ① Match and draw. Trace.

- 1 bike
- 2 doll
- 3 skateboard
- 4 scooter
- 5 ball
- 6 kite
- 7 skipping rope
- 8 book

### Unit 1 Reinforcement 2

#### ① Look, read and tick ✓.

- 1 ball, big
- 2 doll, new
- 3 book, small
- 4 scooter, old

#### ② Trace. Look, read and number.

- 3 big, 4 small, 1 old, 2 new

### Unit 2 Reinforcement 1

#### ① Follow and trace. Tick ✓ or cross ✗.

- 1 ✓ 2 ✗ 3 ✗ 4 ✓ 5 ✗ 6 ✓ 7 ✗ 8 ✓

### Unit 2 Reinforcement 2

#### ① Look, read and tick ✓.

- 1 body, tail, nose, legs
- 2 body, legs
- 3 body, tail
- 4 body, tail, legs

#### ② Trace. Look and number.

- body 3  
legs 4  
nose 2  
tail 1

### Unit 3 Reinforcement 1

#### ① Complete. ② Read and circle.

- 1 lorry
- 2 taxi
- 3 bus
- 4 car
- 5 helicopter
- 6 train
- 7 motorbike
- 8 plane

### Unit 3 Reinforcement 2

#### ① What's next? Match and write.

- 1 walk
- 2 run
- 3 eat
- 4 shout

### Unit 4 Reinforcement 1

#### ① Look and number.

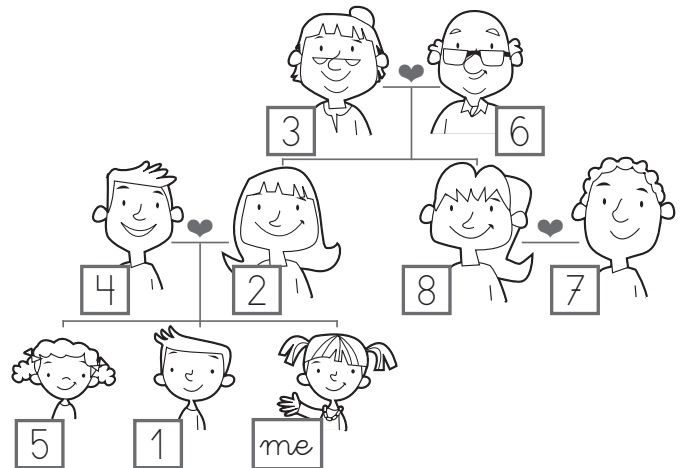

#### ② Write. ③ Read and circle.

- 1 grandma
- 2 brother
- 3 grandpa
- 4 uncle
- 5 sister
- 6 dad
- 7 mum
- 8 aunty

### Unit 4 Reinforcement 2

#### ① Match.

dance, sing, skip, jump

#### ② Complete. ③ Write.

- 1 He can *dance*.
- 2 She can *jump*.
- 3 She can *skip*.
- 4 He can *sing*.

### Unit 5 Reinforcement 1

#### ① Circle. ② Write.

- 1 T-shirt
- 2 jacket
- 3 trousers
- 4 shoes
- 5 dress
- 6 cap
- 7 skirt
- 8 sunglasses

#### ③ Look and write. ④ Read and colour.

- 1 jacket
- 2 trousers
- 3 skirt
- 4 shoes

**Unit 5 Reinforcement 2****① Follow and draw.**

- 1 hungry
- 2 tired
- 3 thirsty
- 4 sad
- 5 happy

**② Match and write.**

- 1 happy
- 2 thirsty
- 3 tired
- 4 hungry
- 5 sad

**Unit 6 Reinforcement 1****① Join and trace. ② Count and write.**

- 1 apples 6
- 2 cakes 5
- 3 sausages 8
- 4 tomatoes 8
- 5 eggs 4
- 6 olives 6
- 7 strawberries 12
- 8 sandwiches 10

**Unit 6 Reinforcement 2****① Read and colour. ② Look and write.****③ Draw 😊 or ☹️ for you.**

- 1 cherries
- 2 apples
- 3 peaches
- 4 pears
- 5 oranges
- 6 olives
- 7 grapes
- 8 strawberries

**Unit 1 Extension 1****① Look and draw. ② Write.**

- 1 bike
- 2 ball
- 3 doll
- 4 scooter
- 5 skipping rope
- 6 skateboard
- 7 book
- 8 kite

**Unit 1 Extension 2****① Follow and write.**

- 1 I've got a *book*. It's *small*.
- 2 I've got a *doll*. It's *old*.
- 3 I've got a *ball*. It's *big*.
- 4 I've got a *scooter*. It's *new*.

**Unit 2 Extension 1****① Complete. ② Write.**

- 1 It's a *horse*.
- 2 It's a *cat*.
- 3 It's a *rabbit*.
- 4 It's a *dog*.
- 5 It's a *mouse*.
- 6 It's a *bird*.
- 7 It's a *frog*.
- 8 It's a *fish*.

**Unit 2 Extension 2****① Match and write. ② Read and colour.**

- 1 dog
- 2 horse
- 3 fish
- 4 frog

**Unit 3 Extension 1****① Look and write.**

- 1 bus
- 2 helicopter
- 3 train
- 4 plane
- 5 motorbike
- 6 lorry
- 7 taxi
- 8 car

**② Look and colour. ③ Write.**

- 1 I can see a *bus*. It's *red*.
- 2 I can see a *motorbike*. It's *orange*.
- 3 I can see a *plane*. It's *blue*.
- 4 I can see a *train*. It's *green*.

**Unit 3 Extension 2****① Read and match.**

- 1 Tom
- 2 Pam
- 3 Pat
- 4 Emma

**② Write, match and number.**

- Don't eat! 3  
 Don't run! 2  
 Don't shout! 4  
 Walk! 1  
 Eat! 5

**Unit 4 Extension 1****① Look and write.**

- 1 grandma
- 2 grandpa
- 3 dad
- 4 mum
- 5 aunty
- 6 uncle
- 7 my sister
- 8 This is my brother.

**Unit 4 Extension 2****① Look and write.**

- 1 This is my *grandpa*. He can *dance*.
- 2 This is my *sister*. She can *skip*.
- 3 This is my *brother*. He can *jump*.
- 4 This is my *mum*. She can *sing*.

**② Draw and write about your friend.**

(Children's own answers)

**Unit 5 Extension 1****① Write.**

- 1 skirt
- 2 trousers
- 3 jacket
- 4 cap
- 5 dress
- 6 T-shirt
- 7 sunglasses
- 8 shoes

**② Look and write. ③ Draw and write for you.**

I'm wearing a *dress* and *shoes*.

I'm wearing a *T-shirt* and *shorts*.

**Unit 5 Extension 2****① Write and match.**

- 1 She's sad.
- 2 She's tired.
- 3 She's hungry.
- 4 He's hungry.
- 5 She's happy.
- 6 He's tired.
- 7 He's thirsty.
- 8 She's thirsty.

**Unit 6 Extension 1****① Look, circle and write.**

- 1 I like *sausages*.
- 2 I like *tomatoes*.
- 3 I don't like *olives*.
- 4 I don't like *cakes*.
- 5 I like *sandwiches*.
- 6 I don't like *apples*.
- 7 I don't like *eggs*.
- 8 I like *strawberries*.

**② Count and colour.**

sausages - brown

tomatoes - red

olives - green

cakes - brown

sandwiches - yellow

apples - green

eggs - yellow

strawberries - red

**Unit 6 Extension 2****① Follow and write.****② Follow, draw and write for you.**

- 1 I like *cakes*.
- 2 I don't like *grapes*.
- 3 I don't like *peaches*.
- 4 I like *oranges*.
- 5 olives
- 6 cherries

**Halloween Reinforcement****① Match and trace.**

- 1 rat
- 2 witch
- 3 monster
- 4 bat
- 5 pumpkin
- 6 ghost

**Christmas Reinforcement****① Trace, count and write.**

- 1 carrot 3
- 2 mince pie 4
- 3 present 6
- 4 star 8
- 5 stocking 2
- 6 tree 1

**Halloween Extension****① Look, number and write.**

I'm a *witch*. 4

I'm a *rat*. 3

I'm a *ghost*. 1

I'm a *bat*. 6

I'm a *pumpkin*. 5

I'm a *monster*. 2

**Christmas Extension****① Colour the key. ② Look and colour.****③ Look and write.**

- 1 It's a *present*.
- 2 It's a *star*.
- 3 It's a *Christmas tree*.
- 4 It's a *stocking*.
- 5 It's a *mince pie*.
- 6 It's a *carrot*.