

Second year of ENGLISH

Recomendacións para o repaso de vocabulario as fichas que adxunto, para a mellora a nivel auditiva podedes poñer os debuxos ou series que lles gusta en versión orixinal, xa que as televisión de hoxe en día deixan cambiar o idioma e así vanse acostumando a escoitar en inglés.

Vocabulario:

- Obxectos: páxinas: 1 e 2.
- Partes do corpo: páxinas: 3 e 4.
- Familia: páxina: 7
- Roupa: páxinas: 8
- Verbos: páxina: 9

Páxinas web recomendables:

<https://arbolabc.com/juegos-de-ingles>

<https://global.cbeebies.com/>

<http://learnenglishkids.britishcouncil.org/>

Look and write.

bathroom bedroom dining room garage ~~garden~~ hall kitchen living room

1 garden

2 dining room

3 bedroom

4 kitchen

5 living room

6 garage

7 bathroom

8 hall

Follow and write.

1 girl icon

2 boy icon

3 girl icon

4 girl icon

5 boy icon

6 boy icon

7 girl icon

8 boy icon

1 bathroom icon

2 bedroom icon

3 garden icon

4 hall icon

5 kitchen icon

6 living room icon

7 dining room icon

8 garage icon

- 1 She's in the bedroom.
- 2 He's in the _____.
- 3 She's in the _____.
- 4 She's in the _____.
- 5 He's in the _____.
- 6 He's in the _____.
- 7 She's in the _____.
- 8 He's in the _____.

Look and write.

bed ~~bath~~ cupboard sofa table

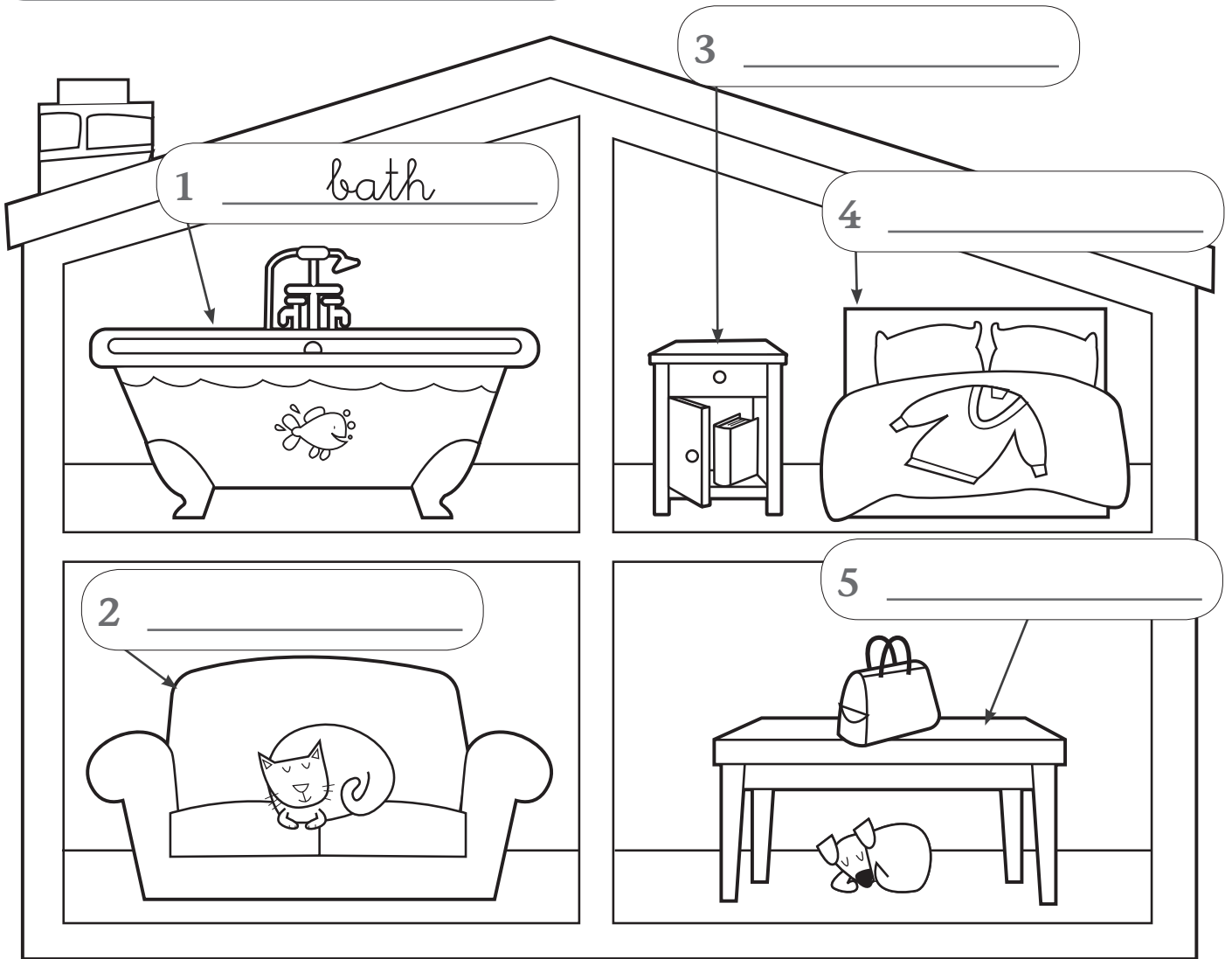

Look, circle and write.

- 1 The cat is in / on / under the sofa.
- 2 The dog is in / on / under the _____.
- 3 The fish is in / on / under the _____.
- 4 The book is in / on / under the _____.
- 5 The jumper is in / on / under the _____.
- 6 The bag is in / on / under the _____.

➤ Look and circle.

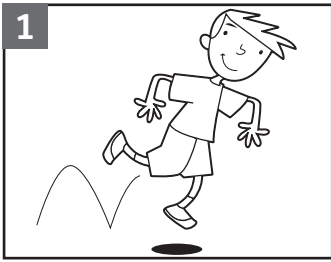

1 catch / hop



2 read / write

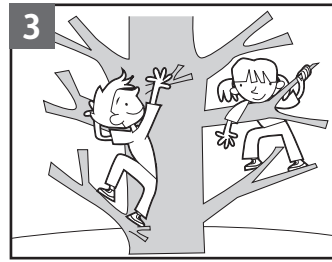

3 climb / write

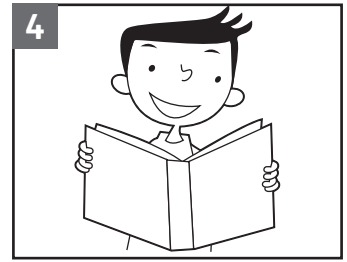

4 read / draw

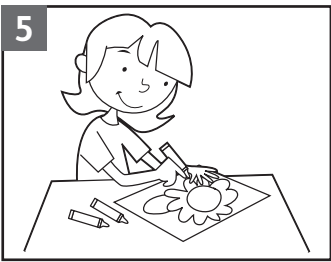

5 draw /
play football



6 hop /
play football

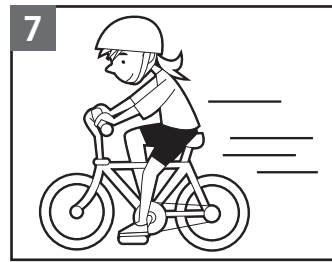

7 ride a bike /
draw

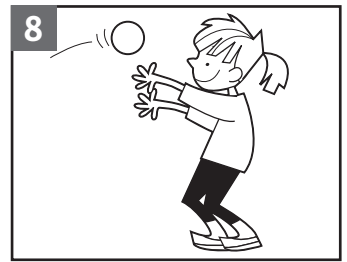

8 ride a bike /
catch

➤ Look and write.

catch climb draw hop play football ~~read~~ ride a bike write

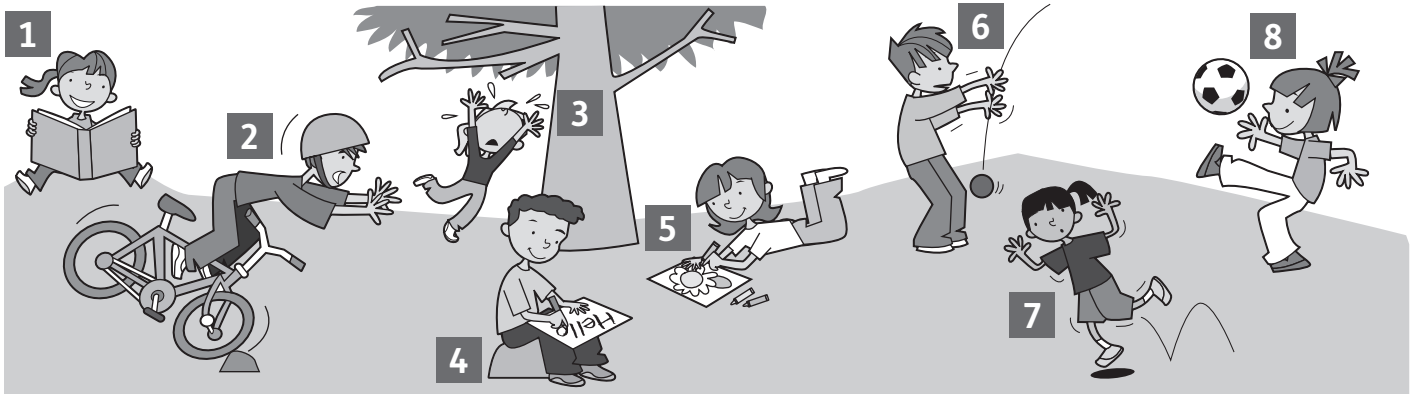

1 She can read.

5 She can _____.

2 He can't _____.

6 He can't _____.

3 She can't _____.

7 She can't _____.

4 He can _____.

8 She can _____.

➤ Circle. ➤ Write.

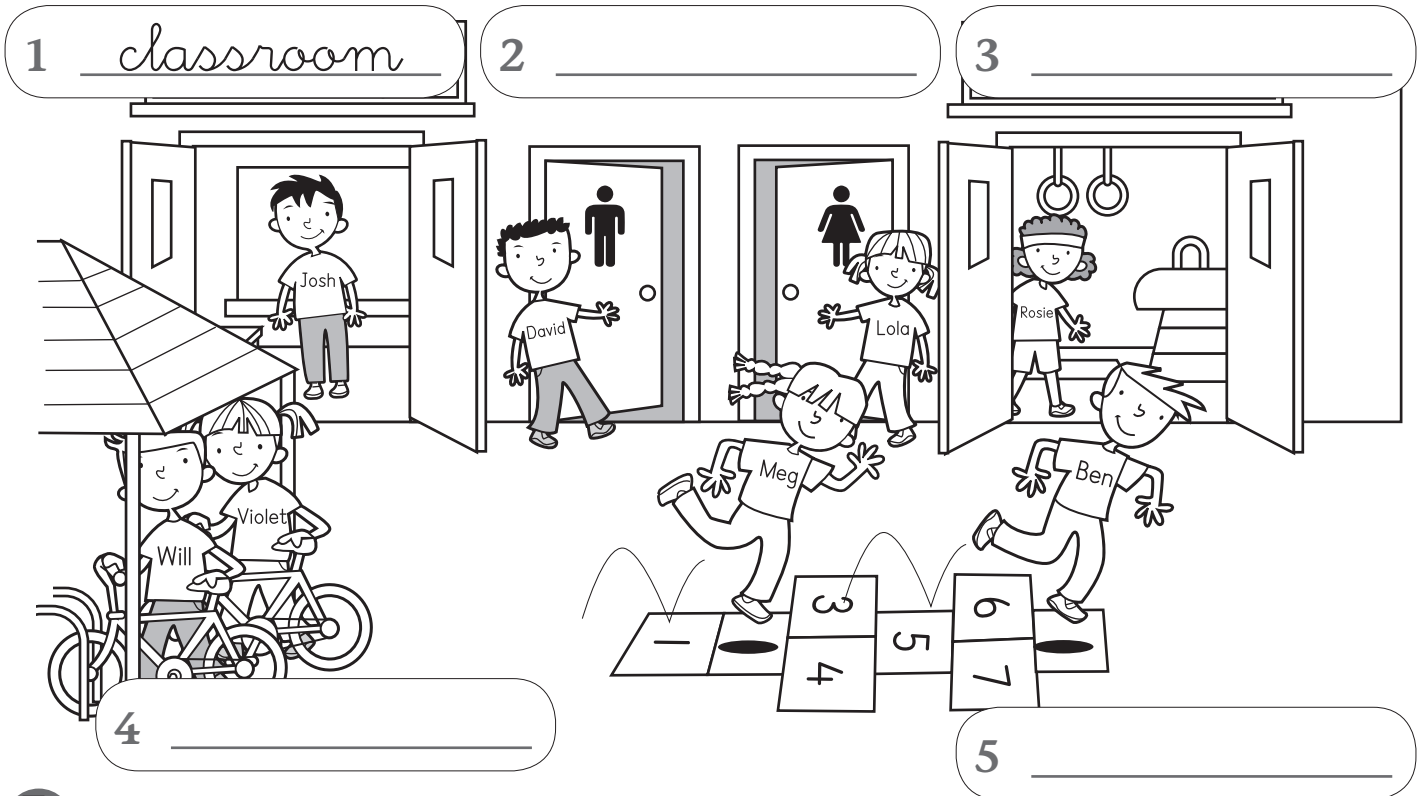
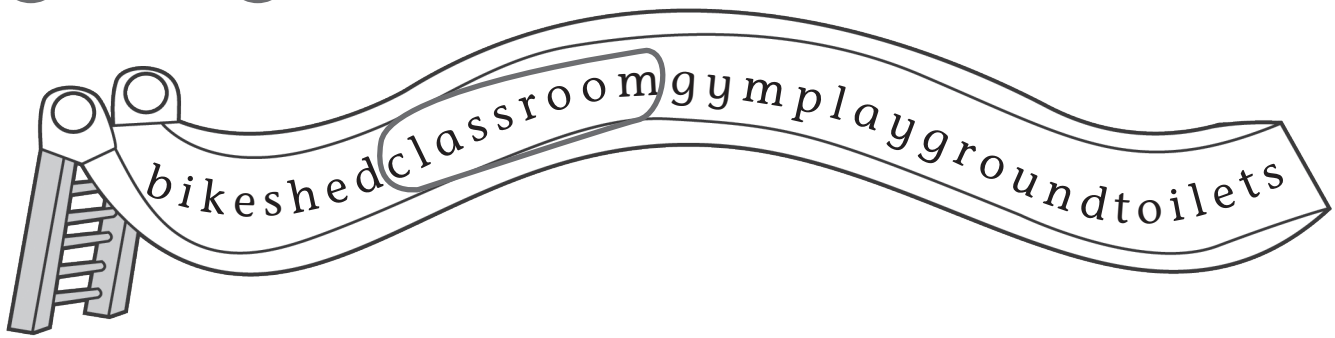

➤ Look and write *He's* or *She's*.

1 _____ in the toilet.

David

2 _____ in the toilet.

Lola

3 _____ in the bike shed.

Will

4 _____ in the classroom.

Josh

5 _____ in the gym.

Rosie

6 _____ in the playground.

Ben

7 _____ in the bike shed.

Violet

8 _____ in the playground.

Meg

Look and write.

farm hill lake ~~rainbow~~ road rock river tree

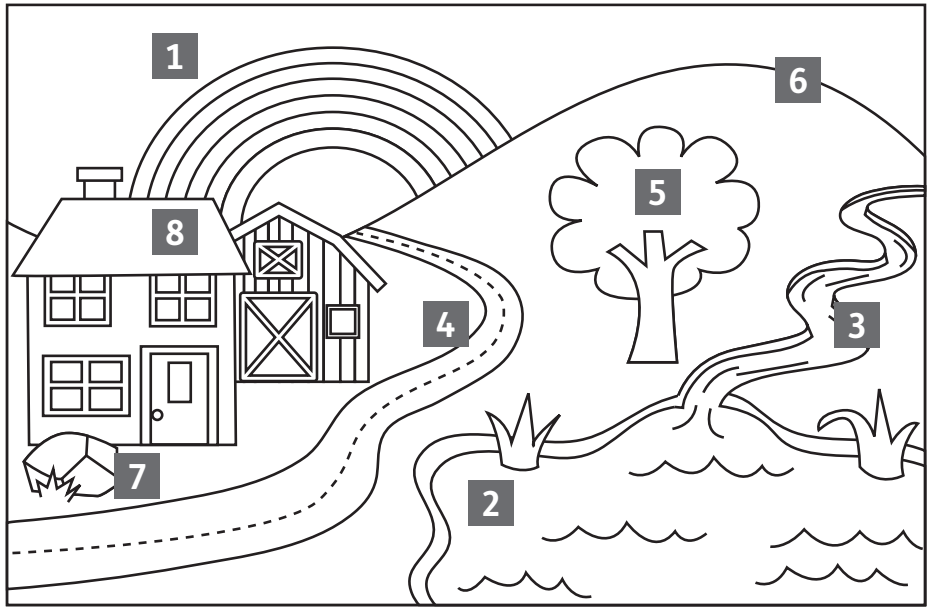

- 1 rainbow
- 2 _____
- 3 _____
- 4 _____
- 5 _____
- 6 _____
- 7 _____
- 8 _____

Read and circle.

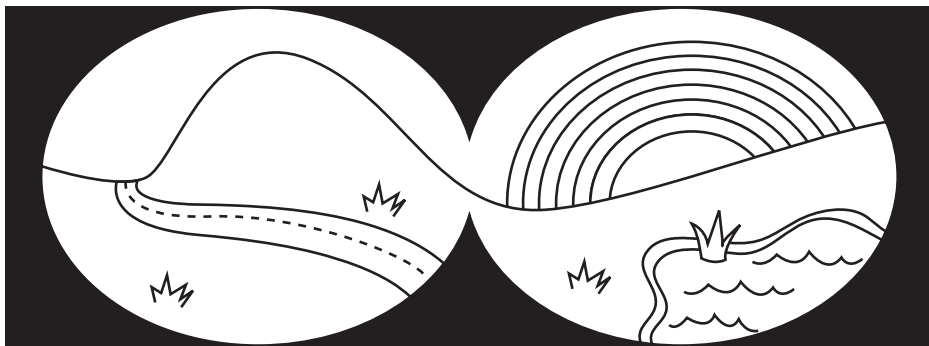

1 Can you see a lake?
Yes, I can. / No, I can't.

2 Can you see a tree?
 Yes, I can. / No, I can't.

3 Can you see a rainbow?
 Yes, I can. / No, I can't.

4 Can you see a hill?
 Yes, I can. / No, I can't.

5 Can you see a river?
 Yes, I can. / No, I can't.

6 Can you see a road?
 Yes, I can. / No, I can't.

7 Can you see a rock?
 Yes, I can. / No, I can't.

8 Can you see a farm?
 Yes, I can. / No, I can't.

Write.

~~deer~~ fox hedgehog owl spider

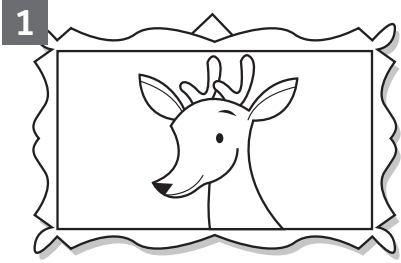

deer

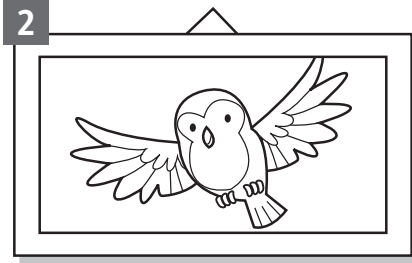

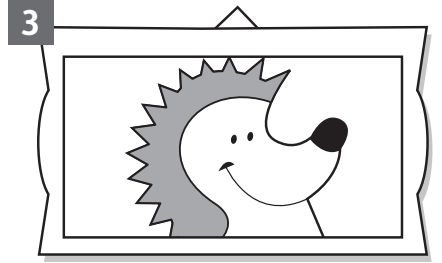

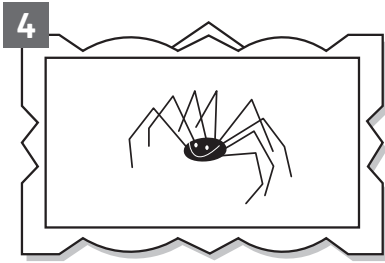

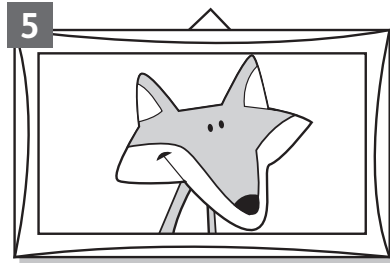

Look and write.

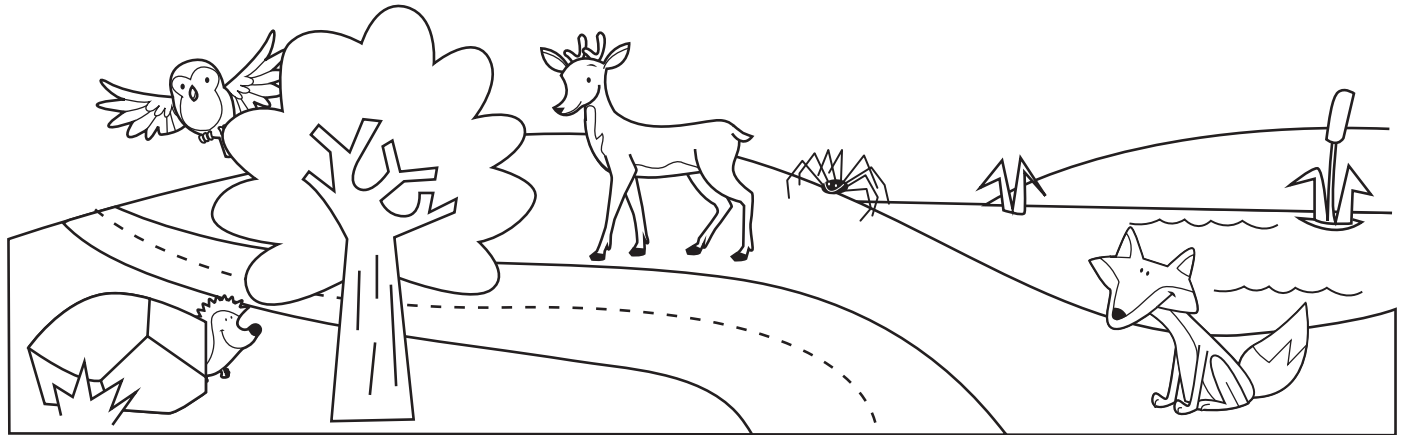

- 1 The fox is in front of the lake.
- 2 The _____ is behind the tree.
- 3 The _____ is next to the lake.
- 4 The _____ is behind the rock.
- 5 The _____ is next to the road.

Write.

dark eyes freckles glasses hair long

1 blond hair

2 _____ hair

3 blue

4

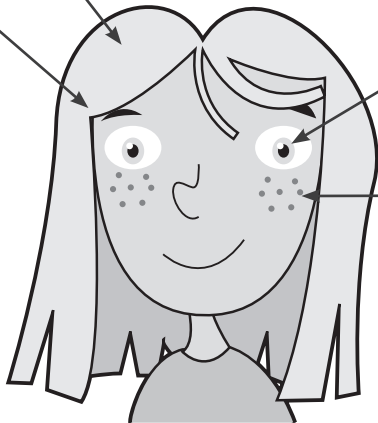

5 short _____

6 _____ hair

7 brown

8

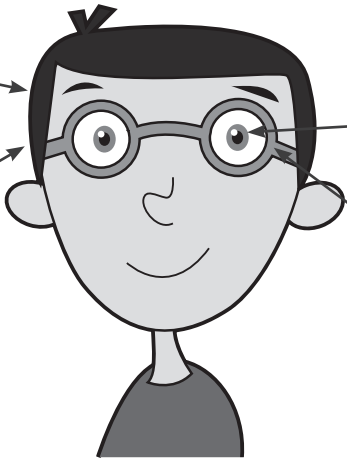

Look and write.

She's got blue eyes.
 She's got long _____.
 She's got _____ hair.
 _____.

He's got _____ eyes.
 He's got _____ hair.
 He's got dark _____.
 _____.

➤ Circle. ➤ Write.

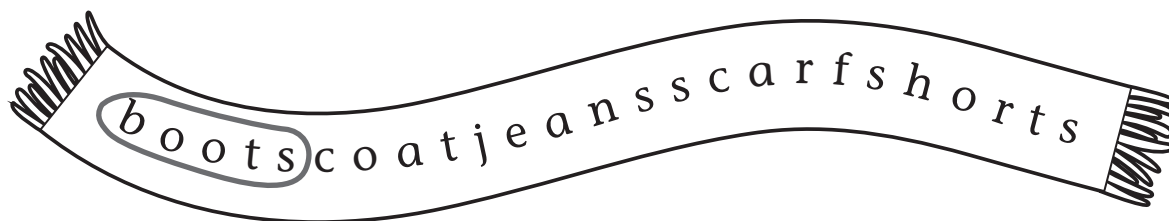

1



boots

2



3



4

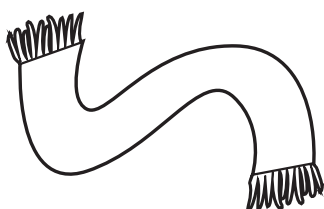

5

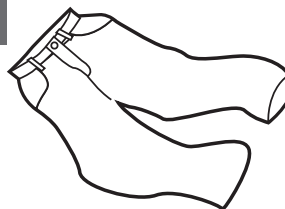

➤ Look, read and write the names.

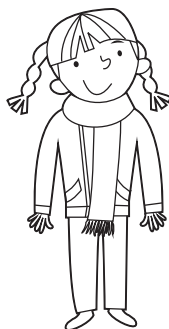

Ruby



Alice



Tom



Beth



Jack



Finn

- 1 He's wearing jeans. Jack
- 2 She's wearing shorts. _____
- 3 He's wearing shorts. _____
- 4 She's wearing jeans and boots. _____
- 5 He's wearing a coat and a scarf. _____
- 6 She's wearing a coat and a scarf. _____

➤ Circle. ➤ Write.

bee chicken cow donkey duck goat pig sheep

1

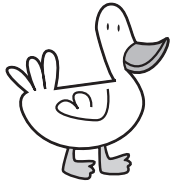

2

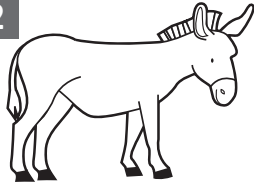

3

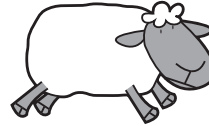

4

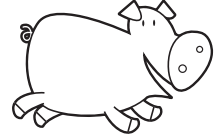

5

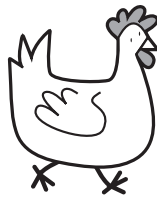

6

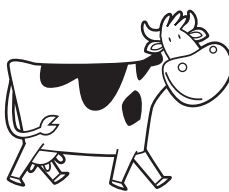

7

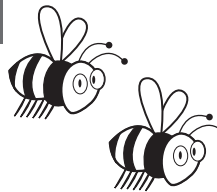

8

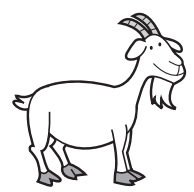

➤ Look and circle.

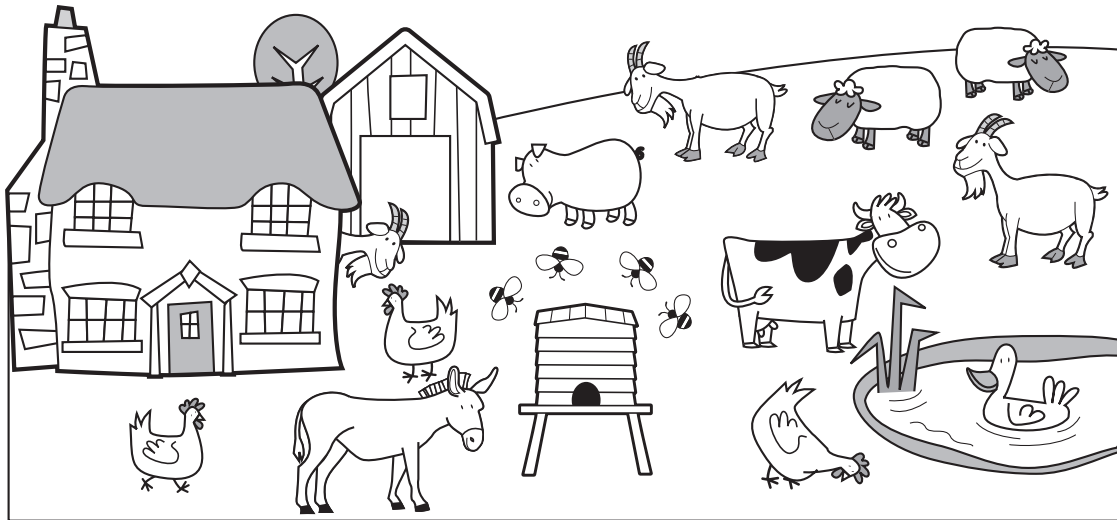

- 1 There is / are a bee / bees.
- 2 There is / are a pig / pigs.
- 3 There is / are a duck / ducks.
- 4 There is / are a chicken / chickens.
- 5 There is / are a cow / cows.
- 6 There is / are a sheep / sheep.
- 7 There is / are a donkey / donkeys.
- 8 There is / are a goat / goats.

Follow and write.

ears feathers feet teeth ~~wings~~

1 wings

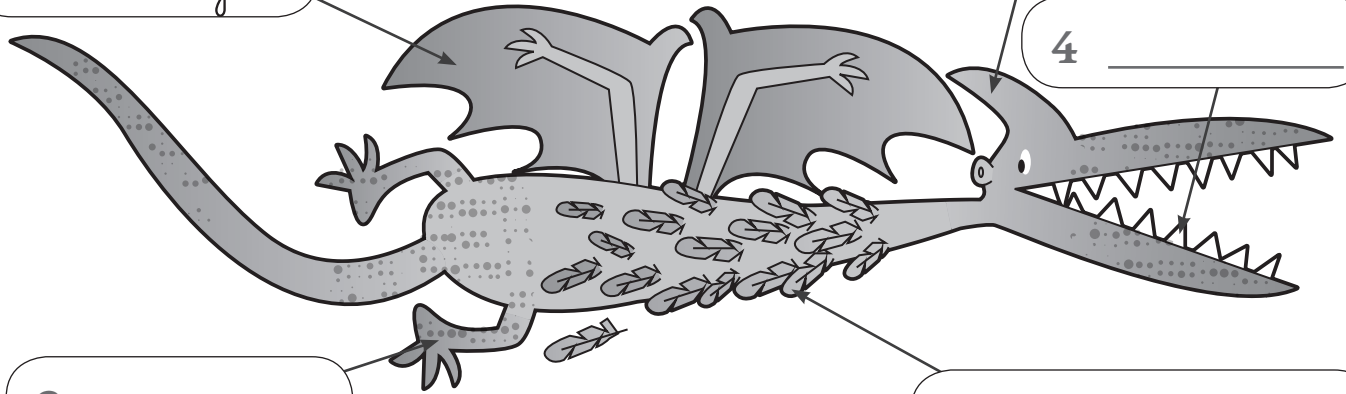



3 _____



4 _____



2 _____

5 _____

Look and write. Read and match.

1 It's got  wings.
It hasn't got  _____.

2 It's got  _____.
It hasn't got  _____.

3 It's got  _____.
It hasn't got  _____.

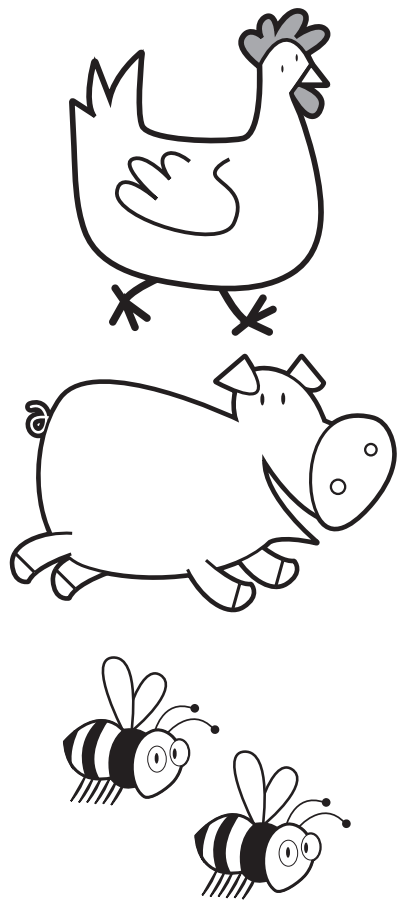

Write.

juice lemonade milk pasta pizza popcorn salad ~~soup~~

1 soup

2 _____

3 _____

4 _____

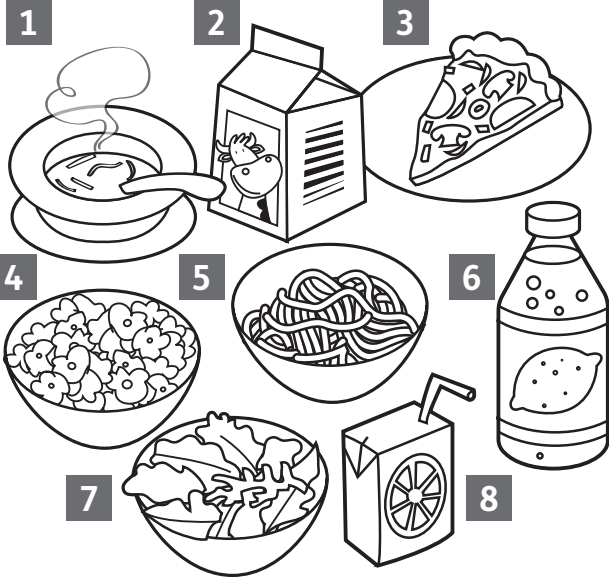

5 _____

6 _____

7 _____

8 _____

Look and write.

1 I'm eating
 pizza and

I'm drinking
_____.

2 I'm eating

I'm drinking
_____.

3 I'm eating
_____ and

I'm drinking
_____.

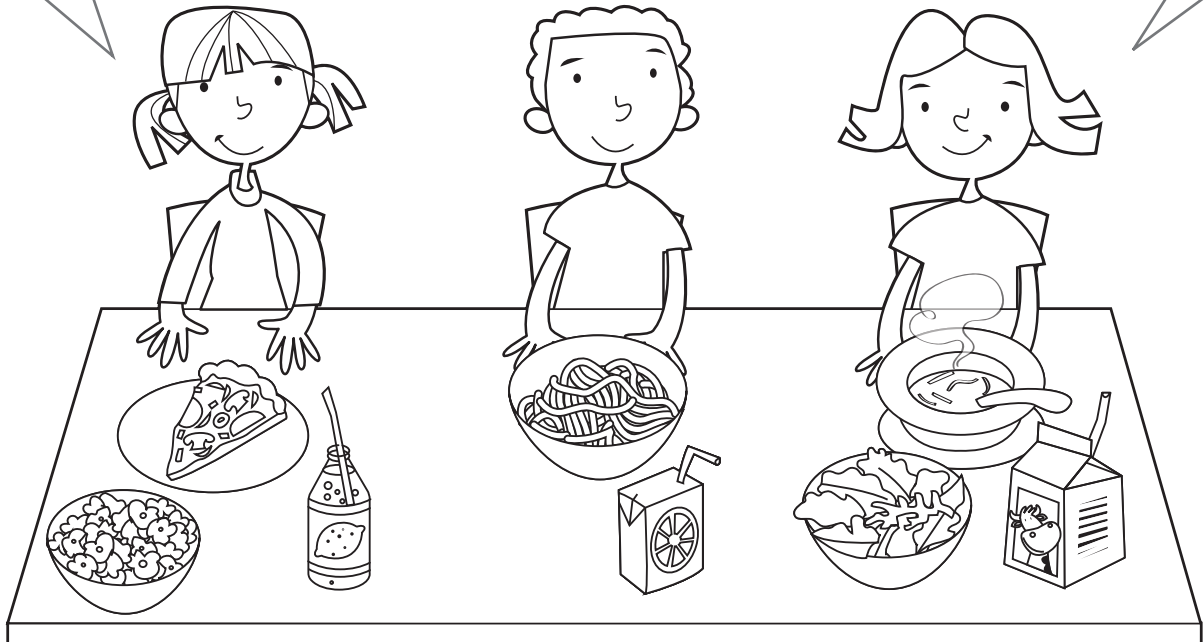

➤ Circle. ➤ Write.

acting dressing up making posters painting playing music

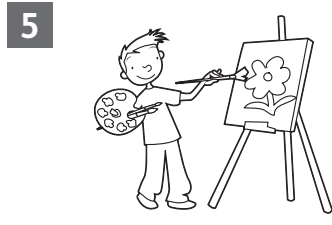
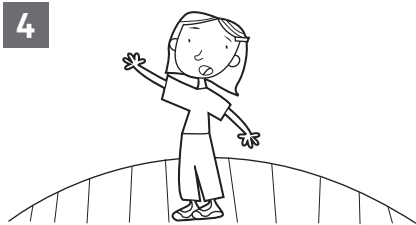
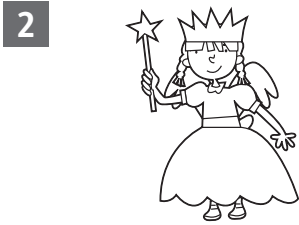
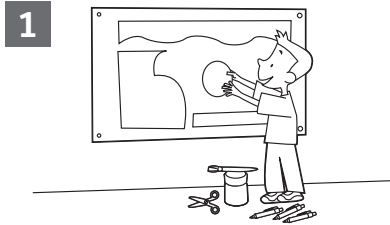

➤ Look and write.

<p>1</p> <p>2</p> <p>3</p>	<p>4</p> <p>5</p>

1 I like dressing up.

4 I don't like _____.

2 I like _____.

5 I don't like _____.

3 I like _____.

1

Look and write.

a a a a a

e e e e

i i i i i

o o o o o o o o

1 b a thr o o m

2 h _ ll

3 b _ dr _ _ m

4 g _ rd _ n

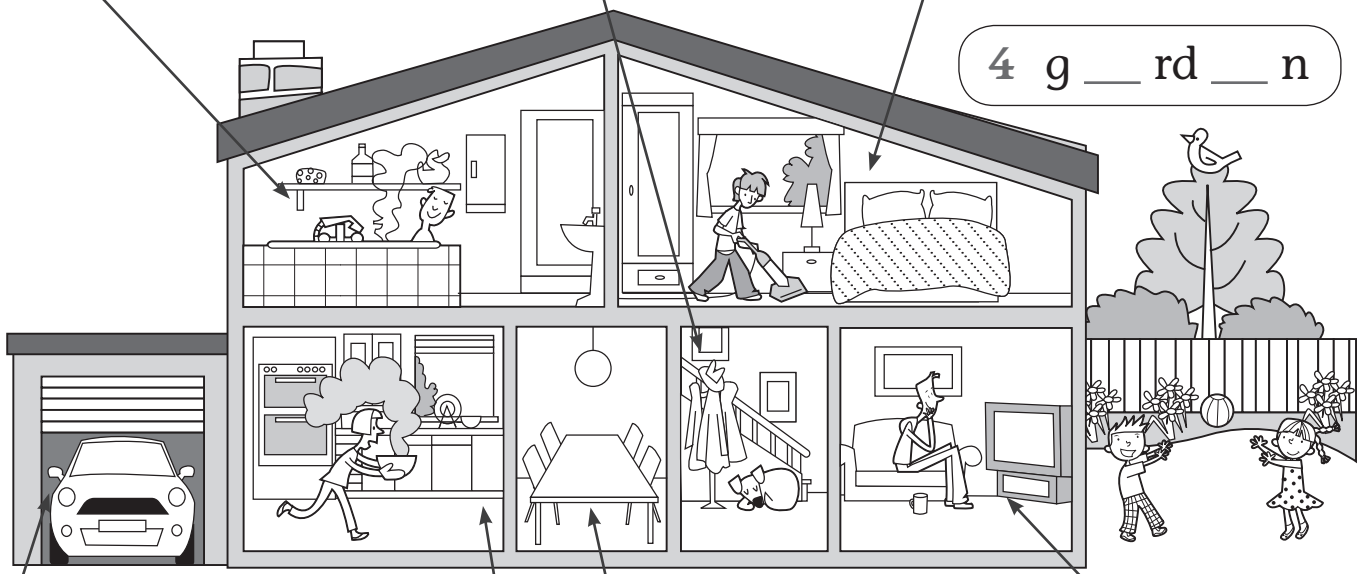

5 g _ r _ g _

7 l _ v _ ng r _ _ m

6 k _ tch _ n

8 d _ n _ ng r _ _ m

Look and write.

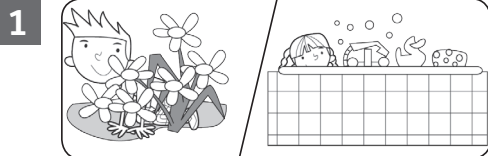

Where is he? He's in the garden.

Where is she? She's in the _____.

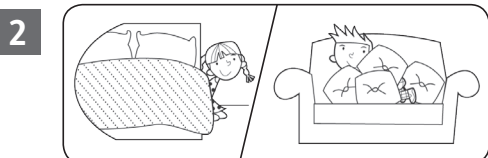

Where is she? _____ in the _____.

Where is he? _____ in the _____.

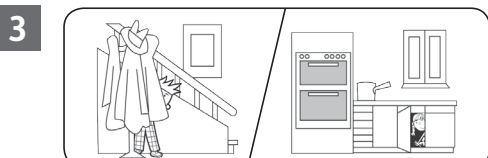

Where is he? _____.

Where is she? _____.

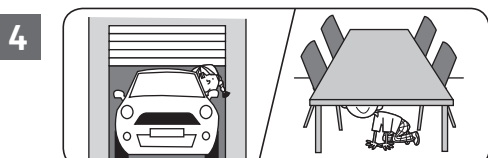

Where is she? _____.

Where is he? _____.

1

Write.

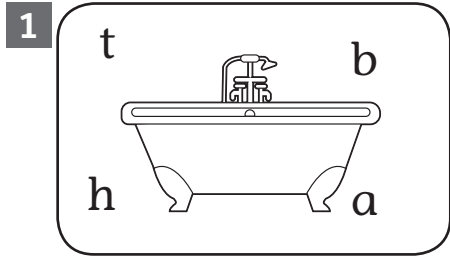

bath

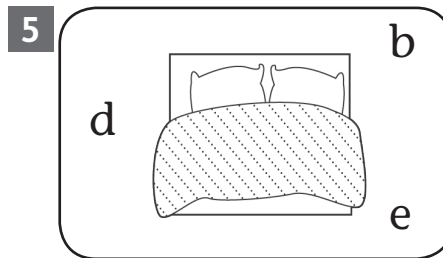
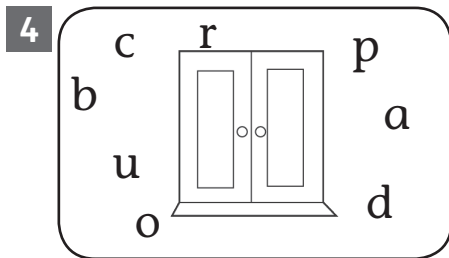
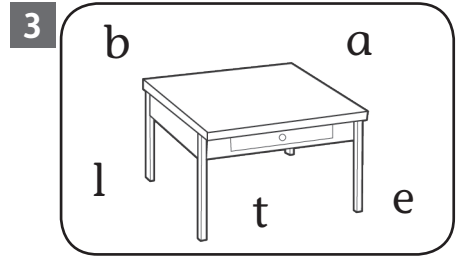
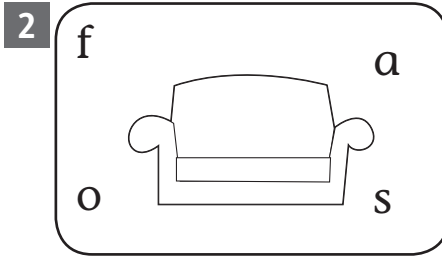

Look and write.

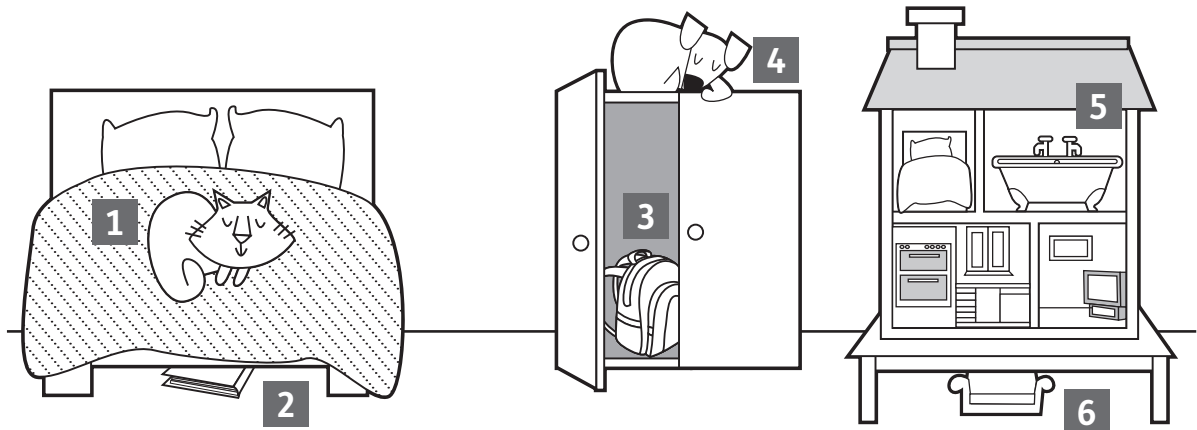

- 1 The cat is on the bed.
- 2 The book is under the _____.
- 3 The bag is in the _____.
- 4 The dog _____ the _____.
- 5 The _____ is _____ the _____.
- 6 _____

Write. Match.

a a a ay ea i ie ie o oo

1 pl ___ f ___ tb ___ ll

2 r ___ de a bik ___

3 cl i mb

4 r ___ d

5 wr ___ t ___

6 dr ___ w

7 c ___ tch

8 h ___ p

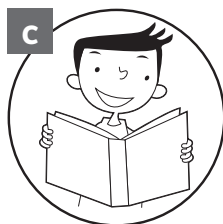
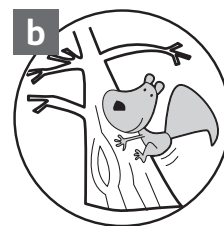
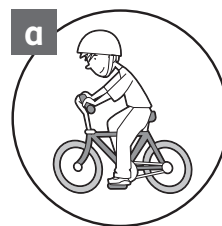

Look, circle and write.



1 He can / can't climb.

2 He can / can't _____.



3 She can / can't _____.

4 He _____.

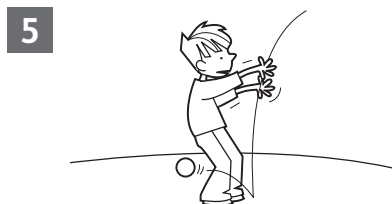

5 He _____.

6 She _____.

2

Write. Find and circle.

a a e e e i i o o o o t u y y

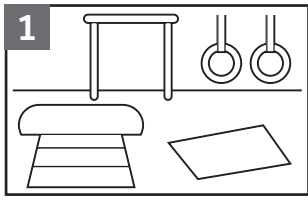

g _ _ m

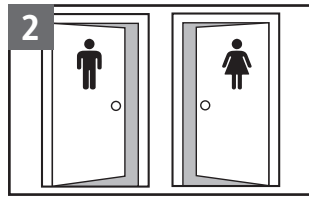

t _ _ l _ _ s

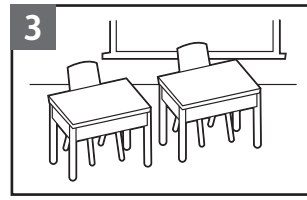

cl _ _ ssr _ _ _ m

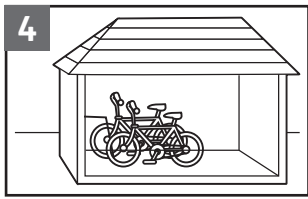

b _ _ k _ _ sh _ _ d

p	c	g	r	c	e	g	e	t	q
e	e	y	y	n	r	e	t	d	s
d	b	m	f	v	e	a	b	o	s
v	r	s	q	o	s	l	p	l	m
t	o	i	l	e	t	s	l	a	a
p	l	a	y	g	r	o	u	n	d
x	e	j	e	o	c	z	g	n	e
c	l	a	s	s	r	o	o	m	i
a	b	b	i	k	e	s	h	e	d

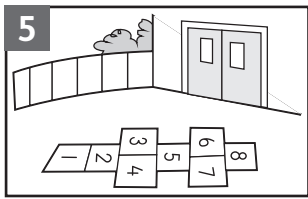

pl _ _ _ gr _ _ _ nd

Look and write.



She is in the classroom.

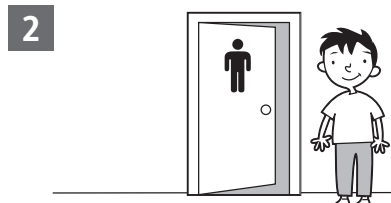

He isn't in the bike shed.

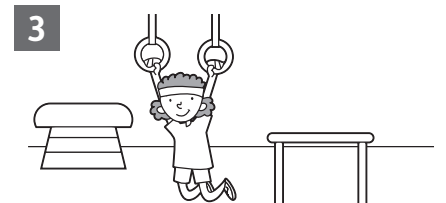

She _____ in the toilets.



He _____ in the gym.



_____ in the playground.

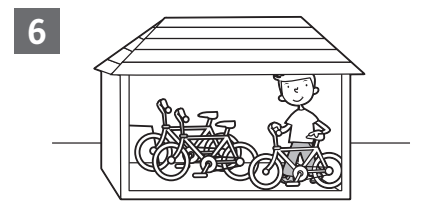

_____ in the gym.

➤ Look and write the differences.

farm hill lake rainbow river road rock tree

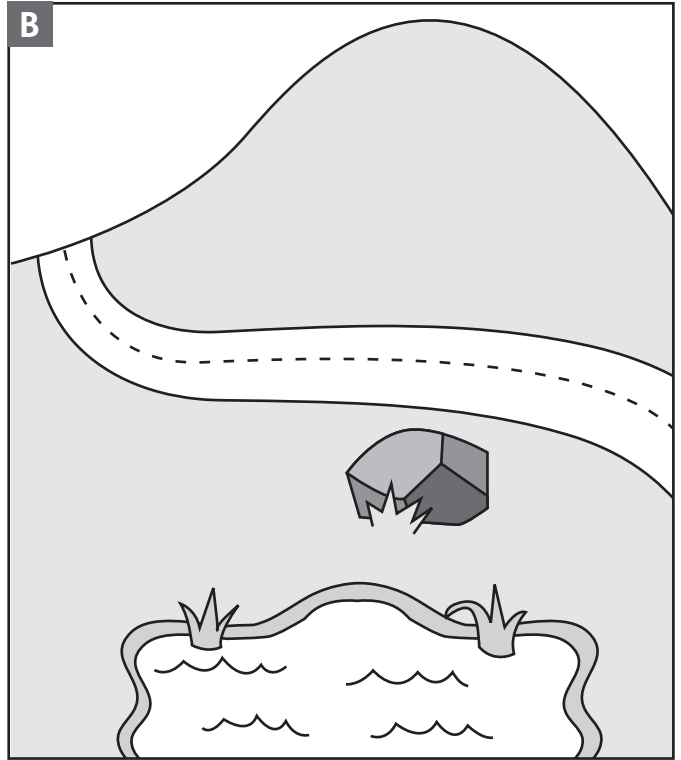
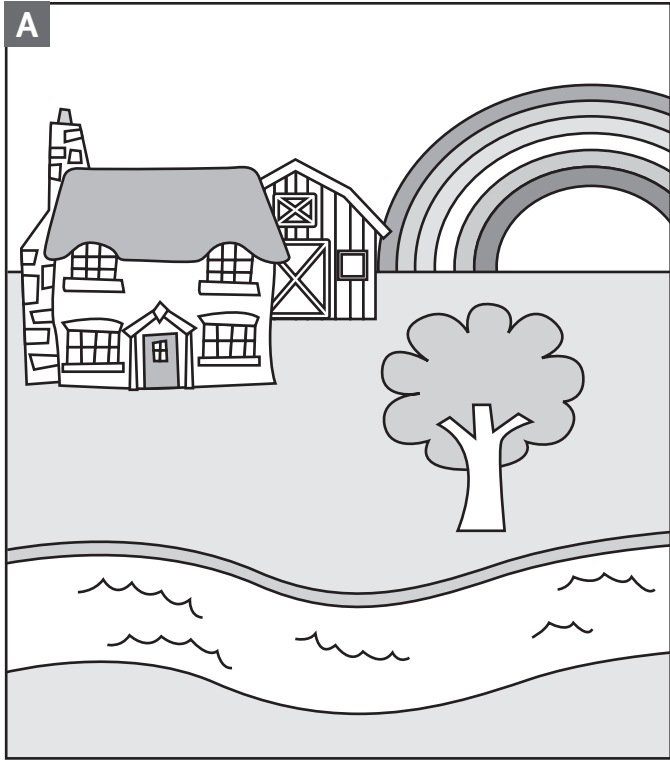

- 1 _____
- 2 _____
- 3 _____
- 4 _____

- 5 _____
- 6 _____
- 7 _____
- 8 _____

➤ Look at picture A and answer *Yes, I can* or *No, I can't*.

- 1 Can you see a river?
Yes, I can.
- 2 Can you see a rock?
No, I _____.
- 3 Can you see a tree?

- 4 Can you see a farm?

- 5 Can you see a road?

- 6 Can you see a lake?

- 7 Can you see a rainbow?

- 8 Can you see a hill?

➤ Look and write.

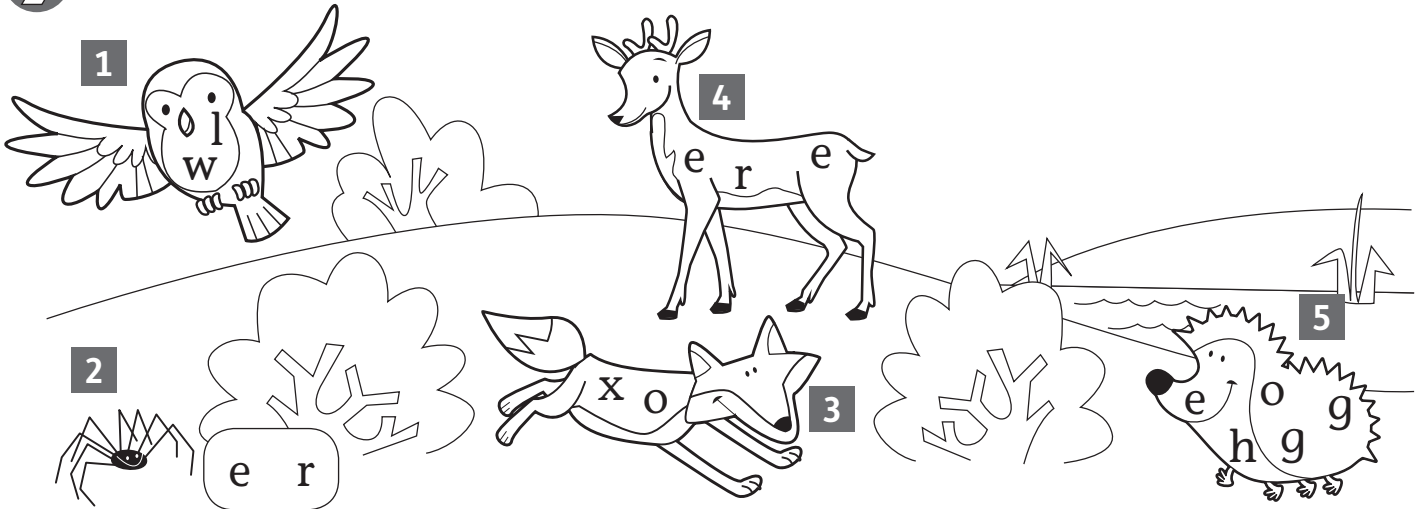

1 o w l

2 spid _ _

3 f _ _

4 d _ _ _

5 hed _ _ _ _

➤ Look and write.

next to behind in front of

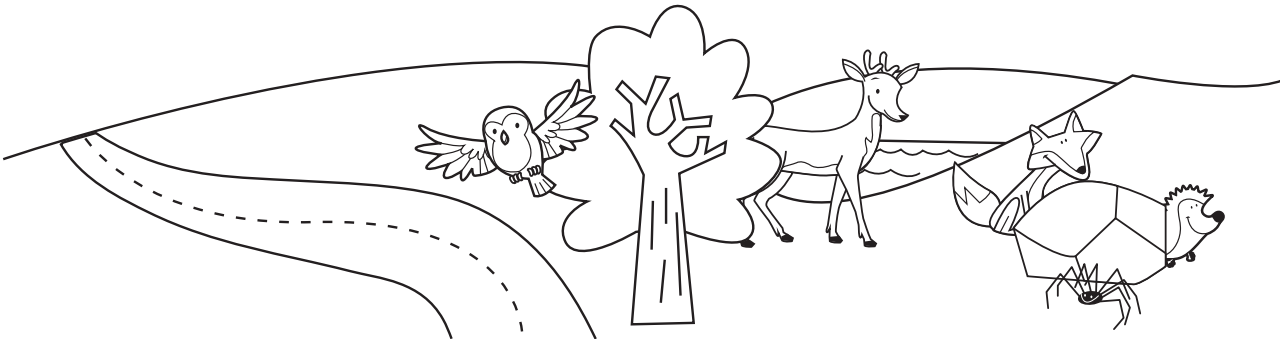

1 The fox is next to the deer.

2 The hedgehog is _____ the rock.

3 The deer is _____ the tree.

4 The owl is _____ the tree.

5 The spider is _____ the rock.

6 The fox is _____ the rock.

7 The owl is _____ the road.

8 The deer is _____ the lake.

Write. Find and circle.

a a

e e e e e e e e

o o o o



bl ___ nd hair



fr ___ ckl ___ s



l ___ ng hair



sh ___ rt hair

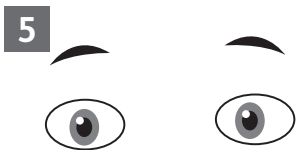

___ y ___ br ___ ws



blue ___ y ___ s



gl ___ ss ___ s



d ___ rk hair

w	n	w	a	e	y	e	s	e
s	l	e	h	e	g	y	c	d
f	r	e	c	k	l	e	s	c
l	o	n	g	x	a	b	h	v
q	s	u	e	d	s	r	o	s
m	g	u	n	a	s	o	r	p
u	l	o	t	r	e	w	t	n
y	l	w	e	k	s	s	m	e
b	m	s	s	u	t	g	j	t

Write. Read, draw and colour.

1 She's got gl_____.

5 He's got fr_____.

2 She's got long _____.

6 He's got blond _____.

3 She's got d_____ hair.

7 He's got s_____ hair.

4 She's got blue _____.

8 He's got brown _____.

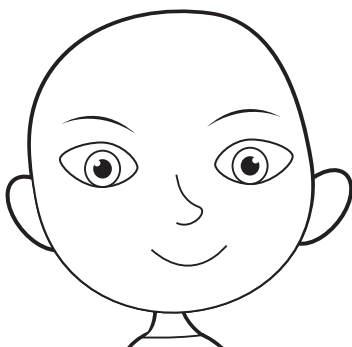

Sarah

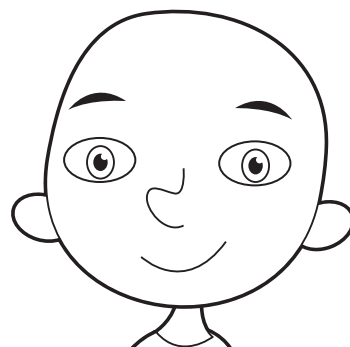

Paul

Write. Match.

1 o a
c t

coat



2 s a c
r f



3 o b t
o s



4 h o s
s t r



5 e a s
j n

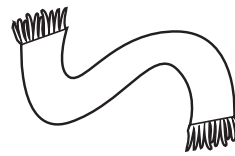

Write.

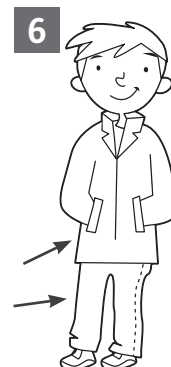
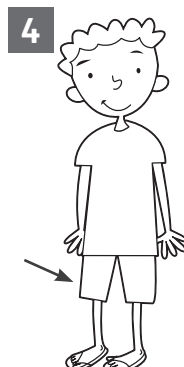
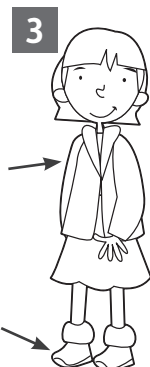
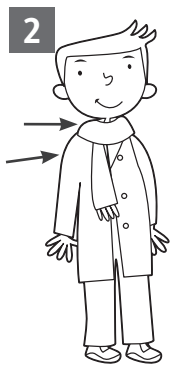
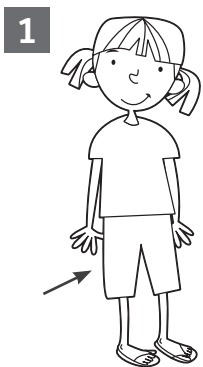

1 She's wearing shorts.

2 He's wearing a _____ and a _____.

3 She's wearing a _____ and _____.

4 _____.

5 _____.

6 _____ and _____.

Look and write. Count.

bees chickens cow donkey ducks goat pigs sheep

a bees

b

c

d

e

f

g

h

Look and write.

- a There are 10 bees.
- b There is 1 donkey.
- c There _____.
- d There _____.
- e _____.
- f _____.
- g _____.
- h _____.

Look and write. Match.

et gs rs th



1 win g s

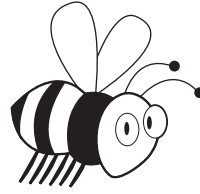
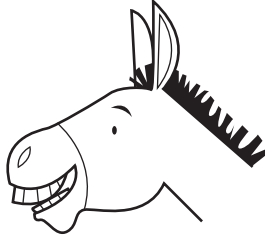

4 feathe _ _



2 fe _ _

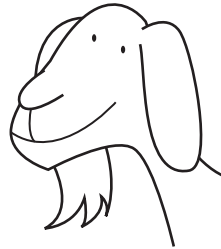
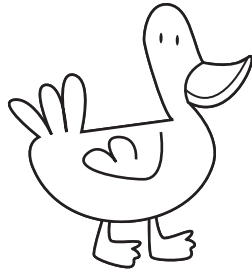

5 tee _ _



3 ea _ _

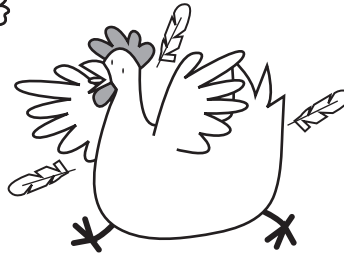

Look and write.

1

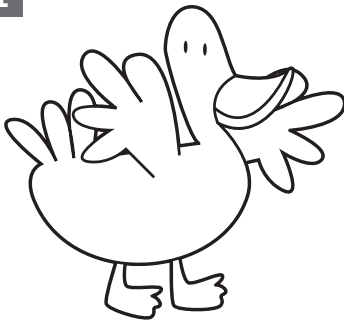

It's got 2 wings.

It's got 2 _____.

 X It hasn't got _____.

 X It hasn't got _____.

2

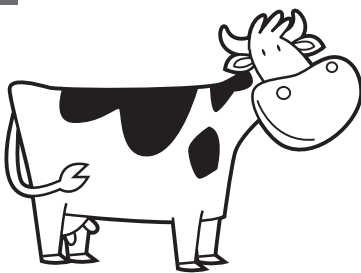

_____ 4 _____.

_____ 2 _____.

 X It hasn't got _____.

 X It hasn't got _____.

6

Look and write. Complete the table.

1 s l a d a



2 n p o c p o

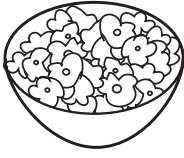

3 i e u c j



4 z a p i z a p



5 e l e a o m n d



6 i m l k



7 s a t p a



8 u p o s



Food	Drink
salad	milk
_____	_____
_____	_____

Write.

1 I'm drinking milk
and _____.
I'm eating
_____.

2 I'm _____.
I'm _____
_____ and
_____.

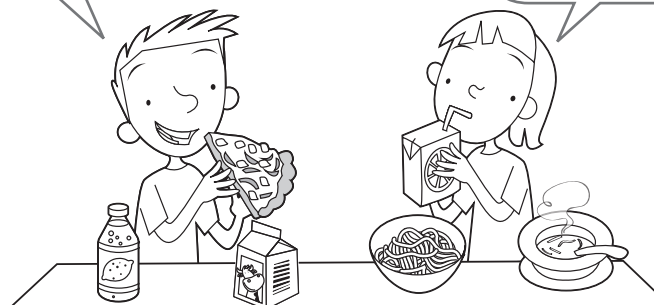

Match and write.

1 dre in ing



2 ac ssing ting

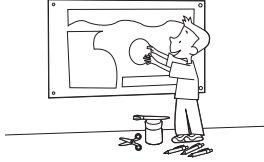

3 pa t up



dressing up

4 ma ying posters



5 pla king music



Look and write.

1 *I like acting.*

2 *I don't like dressing up.*

3 _____

4 _____

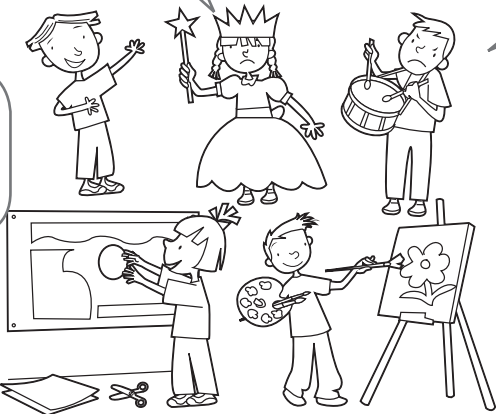

5 _____

Write 2 sentences for you.

I like _____.

I don't like _____.

Unit 1 Reinforcement 1

① Look and write.

- 1 garden
- 2 dining room
- 3 bedroom
- 4 kitchen
- 5 living room
- 6 garage
- 7 bathroom
- 8 hall

② Follow and write.

- 1 bedroom
- 2 garden
- 3 bathroom
- 4 living room
- 5 hall
- 6 garage
- 7 kitchen
- 8 dining room

Unit 1 Reinforcement 2

① Look and write.

- 1 bath
- 2 sofa
- 3 cupboard
- 4 bed
- 5 table

② Look, circle and write.

- 1 The cat is *on* the sofa.
- 2 The dog is *under* the table.
- 3 The fish is *in* the bath.
- 4 The book is *in* the cupboard.
- 5 The jumper is *on* the bed.
- 6 The bag is *on* the table.

Unit 2 Reinforcement 1

① Look and circle.

- 1 hop
- 2 write
- 3 climb
- 4 read
- 5 draw
- 6 play football
- 7 ride a bike
- 8 catch

② Look and write.

- 1 read
- 2 ride a bike
- 3 climb
- 4 write
- 5 draw
- 6 catch
- 7 hop
- 8 play football

Unit 2 Reinforcement 2

① Circle. ② Write.

- 1 classroom
- 2 toilet
- 3 gym
- 4 bike shed
- 5 playground

③ Look and write *He's* or *She's*.

- 1 He's
- 2 She's
- 3 He's
- 4 He's
- 5 She's
- 6 He's
- 7 She's
- 8 She's

Unit 3 Reinforcement 1

① Look and write.

- 1 rainbow
- 2 lake
- 3 river
- 4 road
- 5 tree
- 6 hill
- 7 rock
- 8 farm

② Read and circle.

- 1 Yes, I can.
- 2 No, I can't.
- 3 Yes, I can.
- 4 Yes, I can.
- 5 No, I can't.
- 6 Yes, I can.
- 7 No, I can't.
- 8 No, I can't.

Unit 3 Reinforcement 2

① Write.

- 1 deer
- 2 owl
- 3 hedgehog
- 4 spider
- 5 fox

② Look and write.

- 1 fox
- 2 owl
- 3 spider
- 4 hedgehog
- 5 deer

Unit 4 Reinforcement 1**① Write.**

- 1 blond *hair*
- 2 long hair
- 3 blue *eyes*
- 4 *freckles*
- 5 short *hair*
- 6 dark hair
- 7 brown *eyes*
- 8 *glasses*

② Look and write.

- She's got *blue* eyes.
 She's got long *hair*.
 She's got *blond* hair.
 She's got *freckles*.
 He's got *brown* eyes.
 He's got *short* hair.
 He's got dark *hair*.
 He's got *glasses*.

Unit 4 Reinforcement 2**① Circle. Write.**

- 1 boots
- 2 shorts
- 3 coat
- 4 scarf
- 5 jeans

② Look, read and write the names.

- 1 Jack
- 2 Alice
- 3 Emily
- 4 Beth
- 5 Tom
- 6 Ruby

Unit 5 Reinforcement 1**① Circle. Write.**

- 1 duck
- 2 donkey
- 3 sheep
- 4 pig
- 5 chicken
- 6 cow
- 7 bees
- 8 goat

② Look and circle.

- 1 There are bees.
- 2 There is a pig.
- 3 There is a duck.
- 4 There are chickens.
- 5 There is a cow.
- 6 There are sheep.
- 7 There is a donkey.
- 8 There are goats.

Unit 5 Reinforcement 2**① Follow and write.**

- 1 wings
- 2 feet
- 3 ears
- 4 teeth
- 5 feathers

② Look and write. ③ Read and match.

- 1 It's got *wings*. It hasn't got *feathers*. – bee
- 2 It's got *feathers*. It hasn't got *ears*. – chicken
- 3 It's got *feet*. It hasn't got *wings*. – pig

Unit 6 Reinforcement 1**① Write.**

- 1 soup
- 2 milk
- 3 pizza
- 4 popcorn
- 5 pasta
- 6 lemonade
- 7 salad
- 8 juice

② Look and write.

- 1 I'm eating *pizza* and *popcorn*. I'm drinking *lemonade*.
- 2 I'm eating *pasta*. I'm drinking *juice*.
- 3 I'm eating *soup* and *salad*. I'm drinking *milk*.

Unit 6 Reinforcement 2**① Circle. ② Write.**

- 1 making posters
- 2 dressing up
- 3 playing music
- 4 acting
- 5 painting

③ Look and write.

- 1 I like *dressing up*.
- 2 I like *playing music*.
- 3 I like *acting*.
- 4 I don't like *making posters*.
- 5 I don't like *painting*.

Unit 1 Extension 1**① Look and write.**

- 1 bathroom
- 2 hall
- 3 bedroom
- 4 garden
- 5 garage
- 6 kitchen
- 7 living room
- 8 dining room

② Look and write.

- 1 *He's in the garden. She's in the bathroom.*
- 2 *She's in the bedroom. He's in the living room.*
- 3 *He's in the hall. She's in the kitchen.*
- 4 *She's in the garage. He's in the dining room.*

Unit 1 Extension 2**① Write.**

- 1 bath
- 2 sofa
- 3 table
- 4 cupboard
- 5 bed

② Look and write.

- 1 The cat is *on* the *bed*.
- 2 The book is *under* the *bed*.
- 3 The bag is *in* the *cupboard*.
- 4 The dog is *on* the *cupboard*.
- 5 The *bath* is *in* the *house*.
- 6 *The sofa* is *under* the *table*.

Unit 2 Extension 1**① Write. ② Match.**

- 1 play football - e
- 2 ride a bike - a
- 3 climb - b
- 4 read - c
- 5 write - d
- 6 draw - h
- 7 catch - f
- 8 hop - g

③ Look, circle and write.

- 1 She can't *climb*.
- 2 He can't *ride a bike*.
- 3 She can *read*.
- 4 He *can write*.
- 5 He *can't catch*.
- 6 She *can draw*.

Unit 2 Extension 2**① Write. ② Find and circle.**

- 1 gym
- 2 toilet
- 3 classroom
- 4 bike shed
- 5 playground

③ Look and write.

- 1 She *is* in the classroom.
- 2 He *isn't* in the bike shed.
- 3 She *isn't* in the toilet.
- 4 He *is* in the gym.
- 5 *She is* in the playground.
- 6 *He isn't* in the gym.

Unit 3 Extension 1**① Look and write the differences.**

- 1 farm
- 2 rainbow
- 3 tree
- 4 river
- 5 hill
- 6 road
- 7 rock
- 8 lake

② Look at picture A and answer Yes, I can or No, I can't.

- 1 Yes, I can.
- 2 No, I can't.
- 3 Yes, I can.
- 4 Yes, I can.
- 5 No, I can't.
- 6 No, I can't.
- 7 Yes, I can.
- 8 No, I can't.

Unit 3 Extension 2**① Look and write.**

- 1 owl
- 2 spider
- 3 fox
- 4 deer
- 5 hedgehog

② Look and write.

- 1 The fox is *next to* the deer.
- 2 The hedgehog is *behind* the rock.
- 3 The deer is *behind* the tree.
- 4 The owl is *in front of* the tree.
- 5 The spider is *in front of* the rock.
- 6 The fox is *behind* the rock.
- 7 The owl is *next to* the road.
- 8 The deer is *in front of* the lake.

Unit 4 Extension 1**① Write. ② Find and circle.**

- 1 blond hair
- 2 freckles
- 3 long hair
- 4 short hair
- 5 eyebrows
- 6 blue eyes
- 7 glasses
- 8 dark hair

③ Write. ④ Read, draw and colour.

- 1 She's got *glasses*.
- 2 She's got long *hair*.
- 3 She's got *dark* hair.
- 4 She's got blue *eyes*.
- 5 He's got *freckles*.
- 6 He's got blond *hair*.
- 7 He's got *short* hair.
- 8 He's got brown *eyes*.

Unit 4 Extension 2**① Write. ② Match.**

- 1 coat
- 2 scarf
- 3 boots
- 4 shorts
- 5 jeans

③ Write.

- 1 She's wearing *shorts*.
- 2 He's wearing a *coat* and a *scarf*.
- 3 She's wearing a *coat* and *boots*.
- 4 *He's wearing shorts*.
- 5 *She's wearing jeans*.
- 6 *He's wearing a coat and jeans*.

Unit 5 Extension 1**① Look and write. ② Count.**

- a 10 bees
- b 1 donkey
- c 4 chickens
- d 3 sheep
- e 2 pigs
- f 1 goat
- g 1 cow
- h 5 ducks

③ Look and write.

- a There are 10 bees.
- b There is 1 donkey.
- c There are 4 chickens.
- d There are 3 sheep.
- e There are 2 pigs.
- f There is 1 goat.
- g There is 1 cow.
- h There are 5 ducks.

Unit 5 Extension 2**① Look and write. ② Match.**

- 1 wings
- 2 feet
- 3 ears
- 4 feathers
- 5 teeth

③ Look and write.

- 1 It's got 2 wings.
It's got 2 feet.
It hasn't got ears.
It hasn't got teeth.
- 2 It's got 4 feet.
It's got 2 ears.
It hasn't got wings.
It hasn't got feathers.

Unit 6 Extension 1**① Look and write. ② Complete the table.**

- 1 salad
- 2 popcorn
- 3 juice
- 4 pizza
- 5 lemonade
- 6 milk
- 7 pasta
- 8 soup

Food: salad, popcorn, pizza, pasta, soup**Drink:** juice, lemonade, milk**③ Write.**

I'm *drinking* milk and *lemonade*. I'm *eating* pizza.
I'm *drinking* juice. I'm *eating* pasta and *soup*.

Extension 2 Unit 6**① Match and write.**

- 1 dressing up
- 2 acting
- 3 painting
- 4 making posters
- 5 playing music

② Look and write.

- 1 I like acting.
- 2 I don't like dressing up.
- 3 I don't like playing music.
- 4 I like making posters.
- 5 I like painting.

③ Write 2 sentences for you.

Children's own answers.