

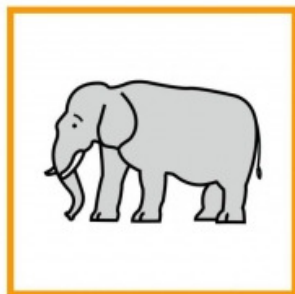

1

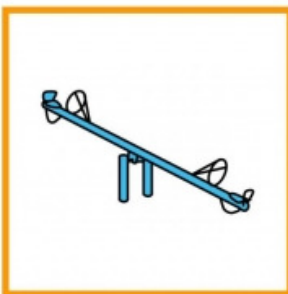

ELEFANTE



SE BALANCEABA



SOBRE

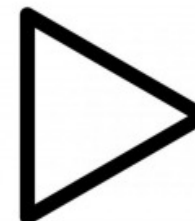

LA

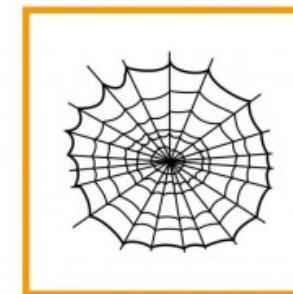

TELA DE UNA ARAÑA

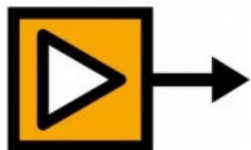

COMO

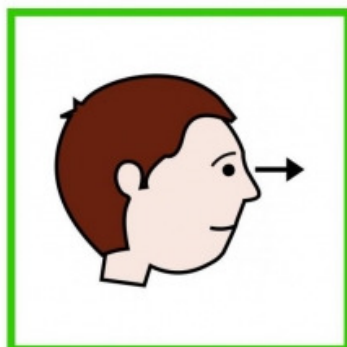

VEÍA



QUE

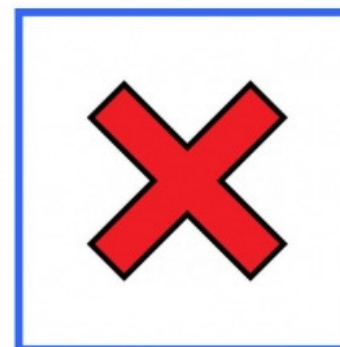

NO



SE CAÍA



FUE

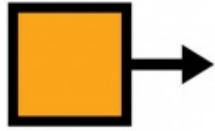

A



LLAMAR

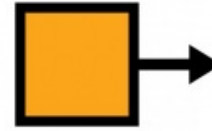

A

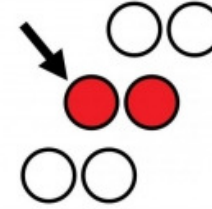

OTRO

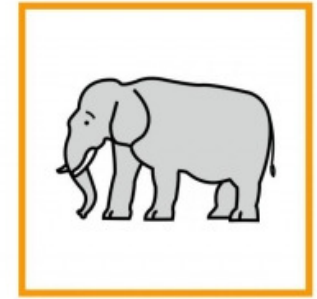

ELEFANTE

2

2

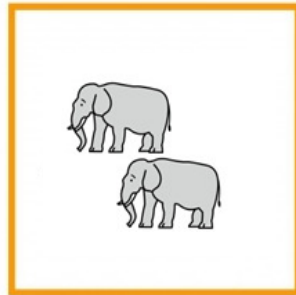

ELEFANTES

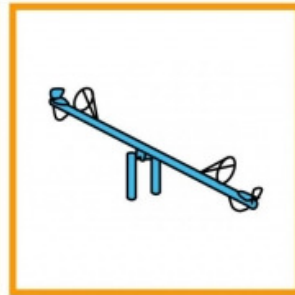

SE BALANCEABAN



SOBRE

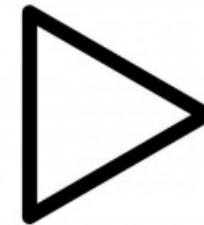

LA



TELA DE UNA ARAÑA

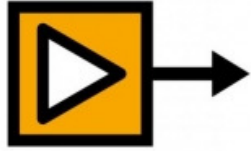

COMO

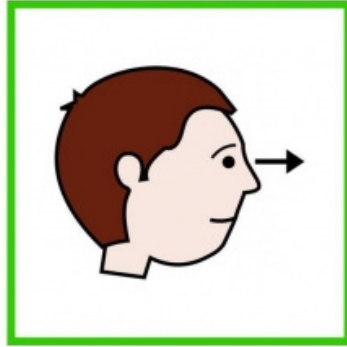

VEÍAN



QUE

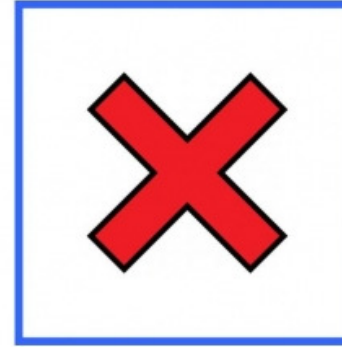

NO



SE CAÍAN



FUERON

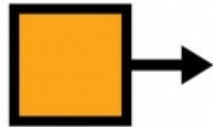

A

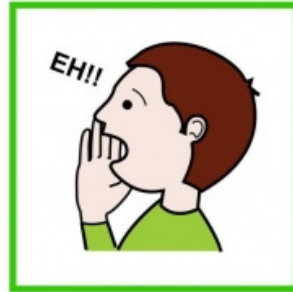

LLAMAR

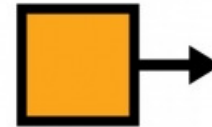

A

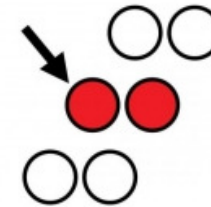

OTRO

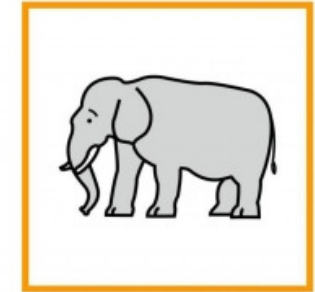

ELEFANTE



3

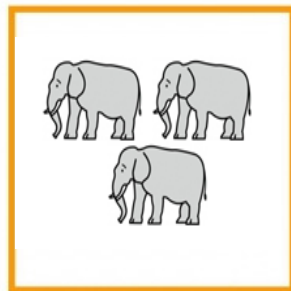

ELEFANTES



SE BALANCEABAN



SOBRE

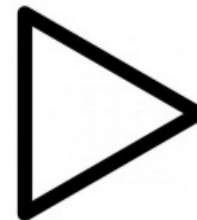

LA

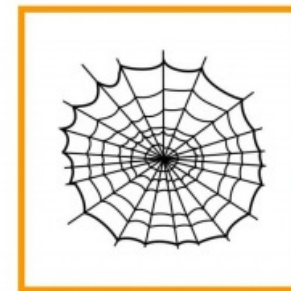

TELA DE UNA ARAÑA

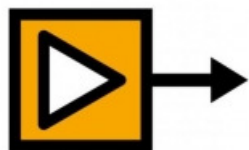

COMO

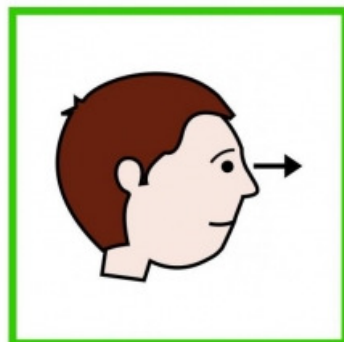

VEÍAN



QUE

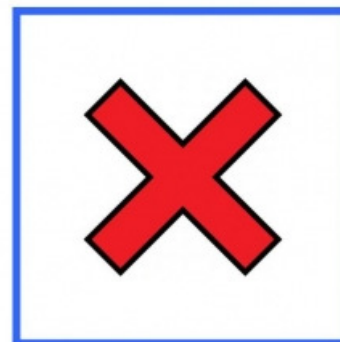

NO



SE CAÍAN



FUERON



A



LLAMAR

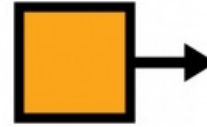

A

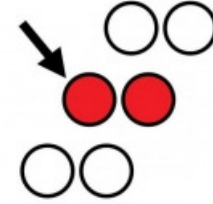

OTRO

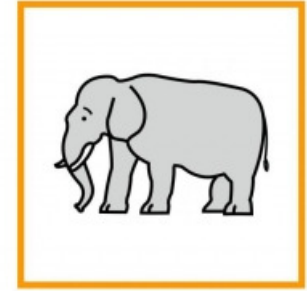

ELEFANTE

4

4

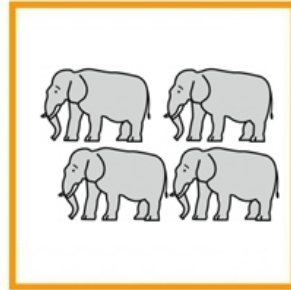

ELEFANTES



SE BALANCEABAN



SOBRE

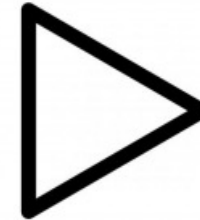

LA



TELA DE UNA ARAÑA

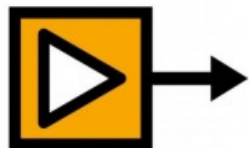

COMO

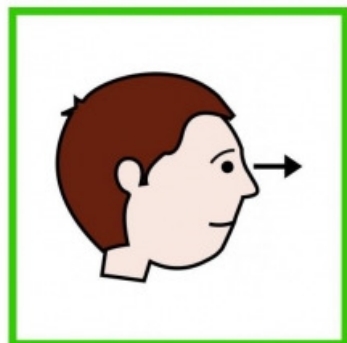

VEÍAN



QUE

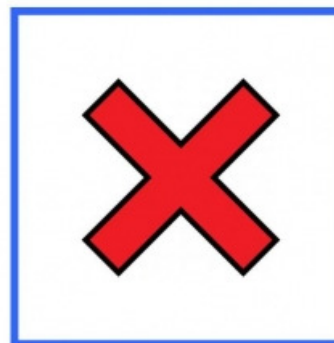

NO



SE CAÍAN

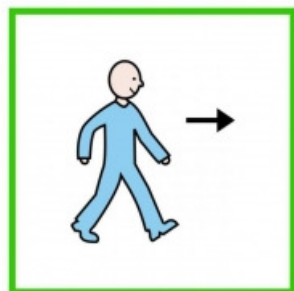

FUERON



A

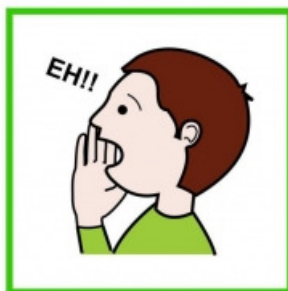

LLAMAR

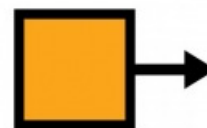

A

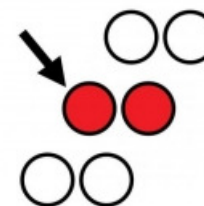

OTRO

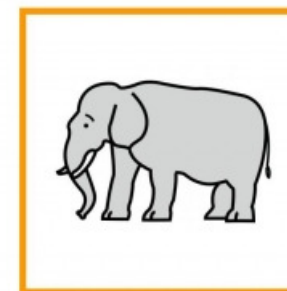

ELEFANTE



5

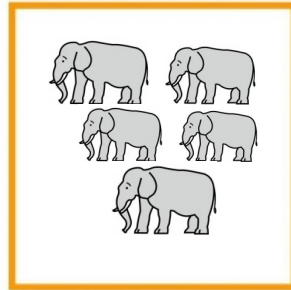

5

ELEFANTES



SE BALANCEABAN



SOBRE

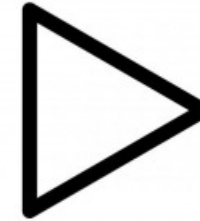

LA



TELA DE UNA ARAÑA

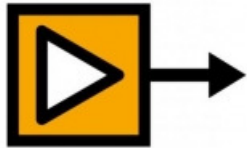

COMO

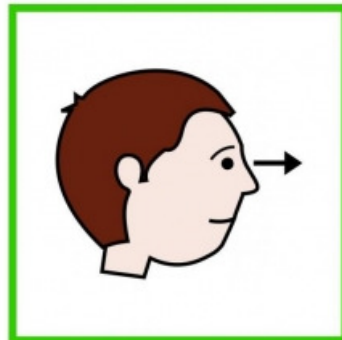

VEÍAN



QUE

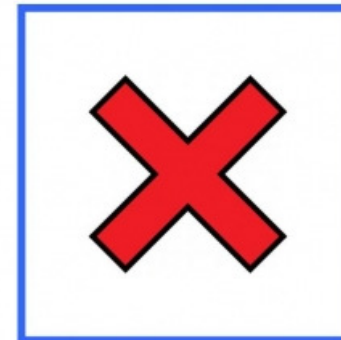

NO



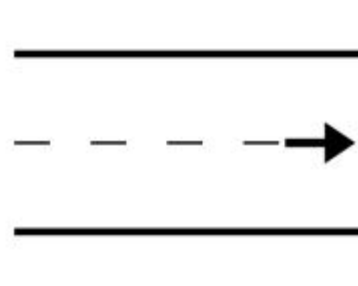
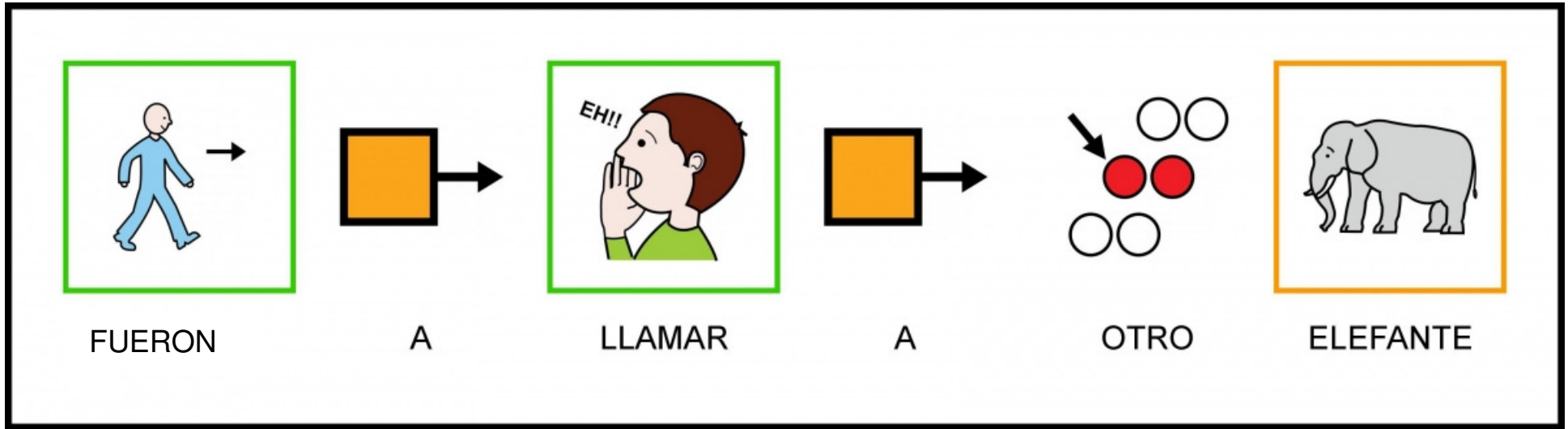

SE CAÍAN



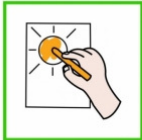

FIN



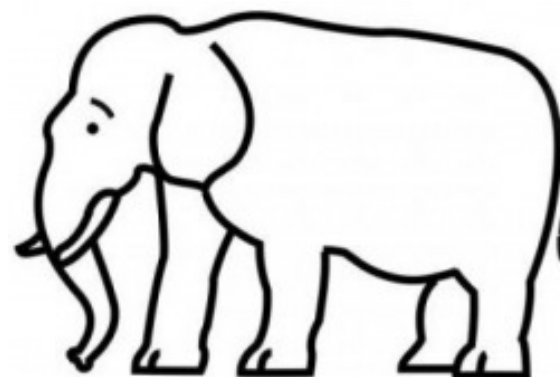
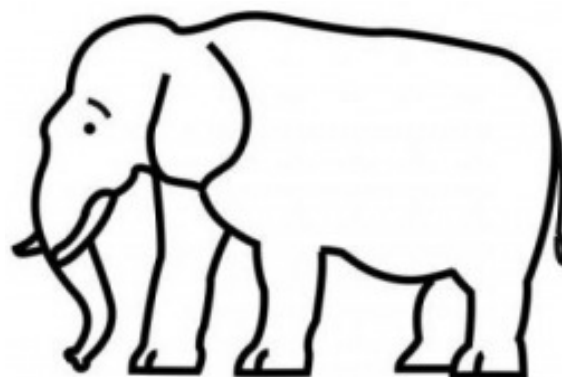
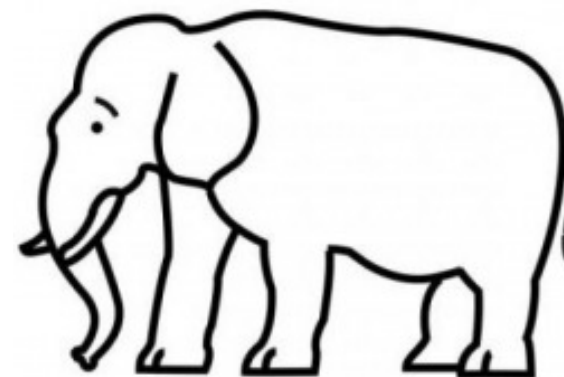
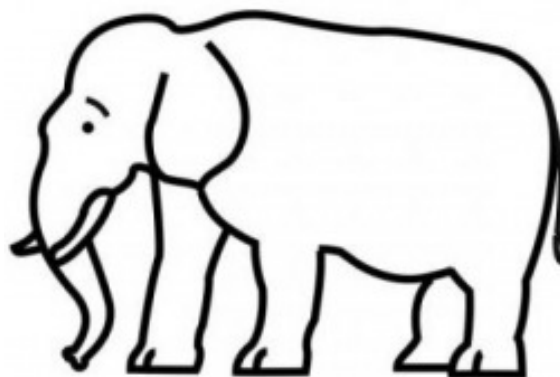
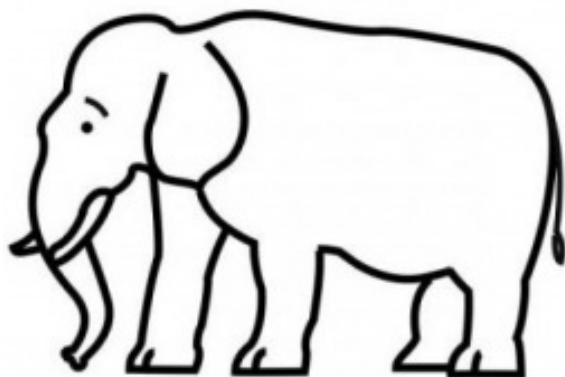

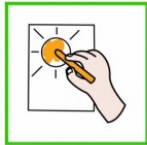
	<b>1</b>	
COLOREA	1	ELEFANTE

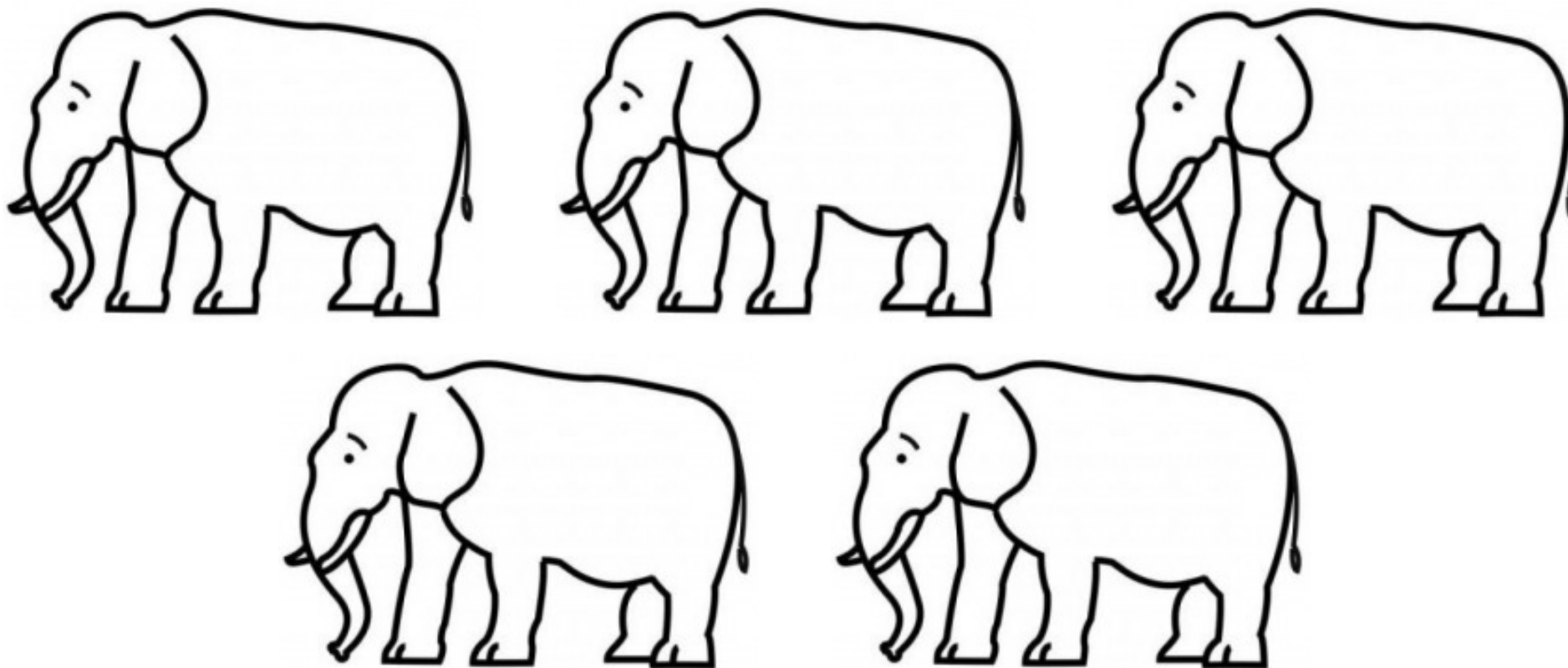

	<b>2</b>	
COLOREAR	2	ELEFANTES

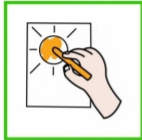

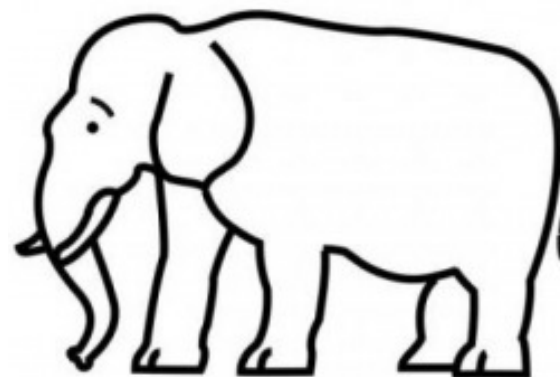
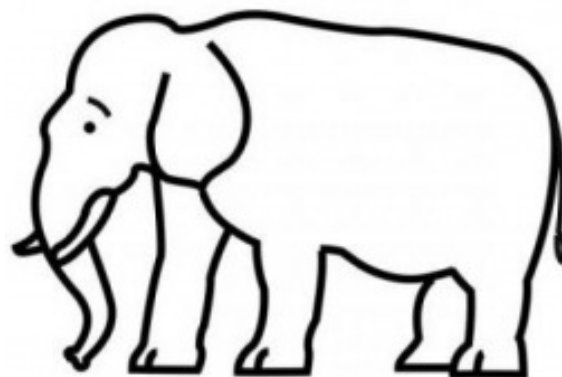
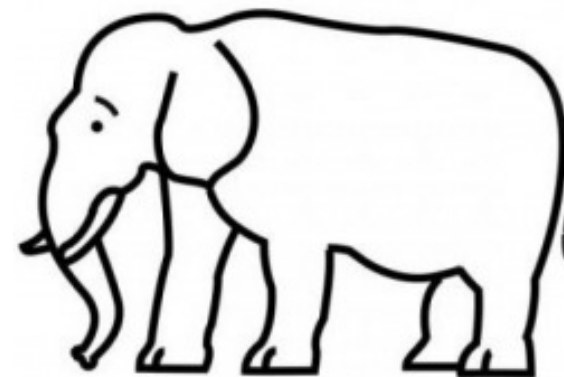
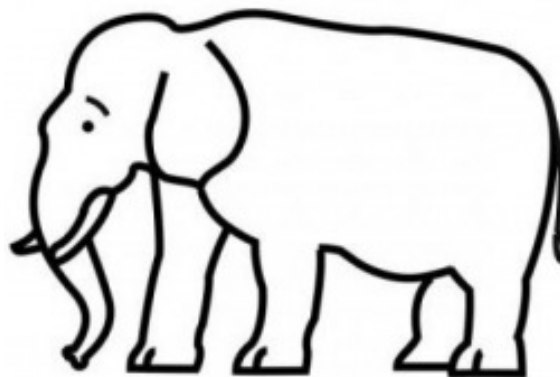
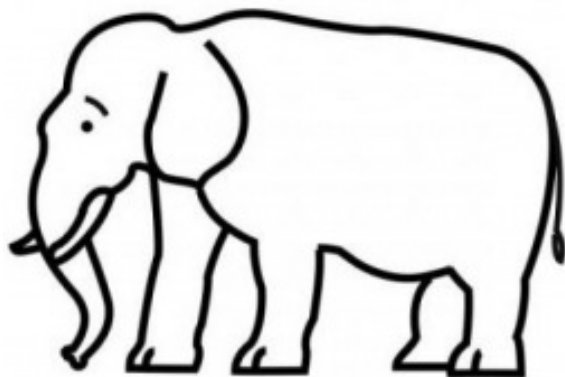

	<b>3</b>	
COLOREAR	3	ELEFANTES

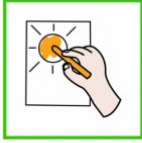
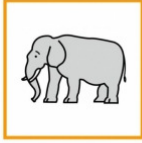

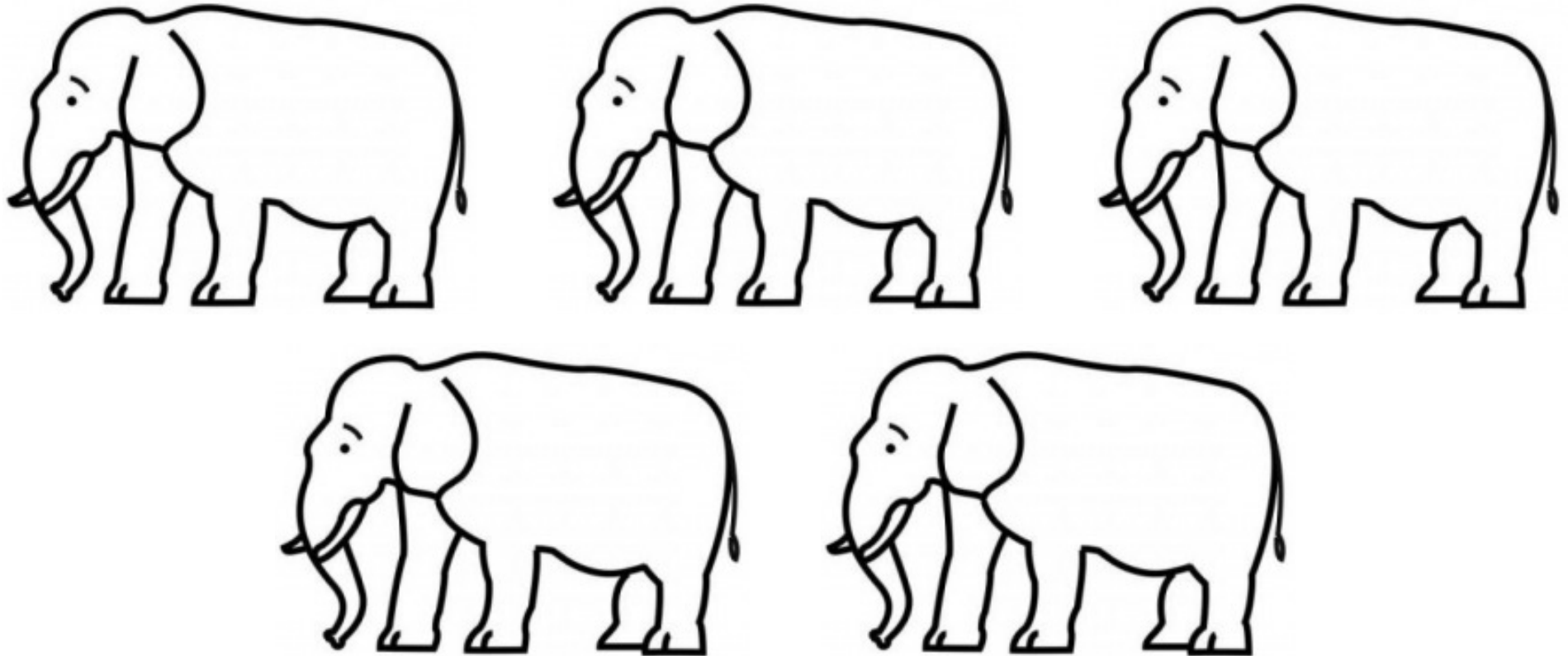

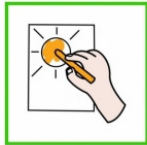

	<b>4</b>	
COLOREAR	4	ELEFANTES

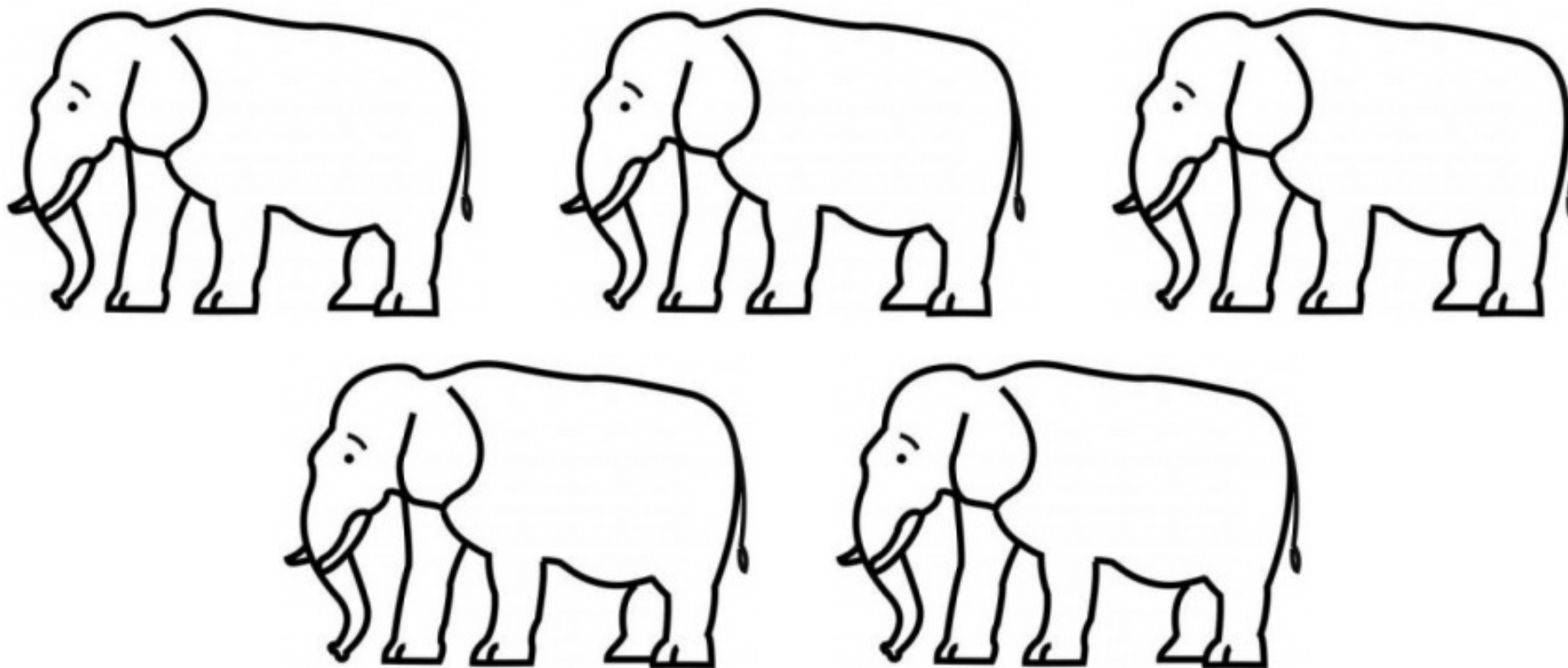





	<b>5</b>	
COLOREAR	5	ELEFANTES

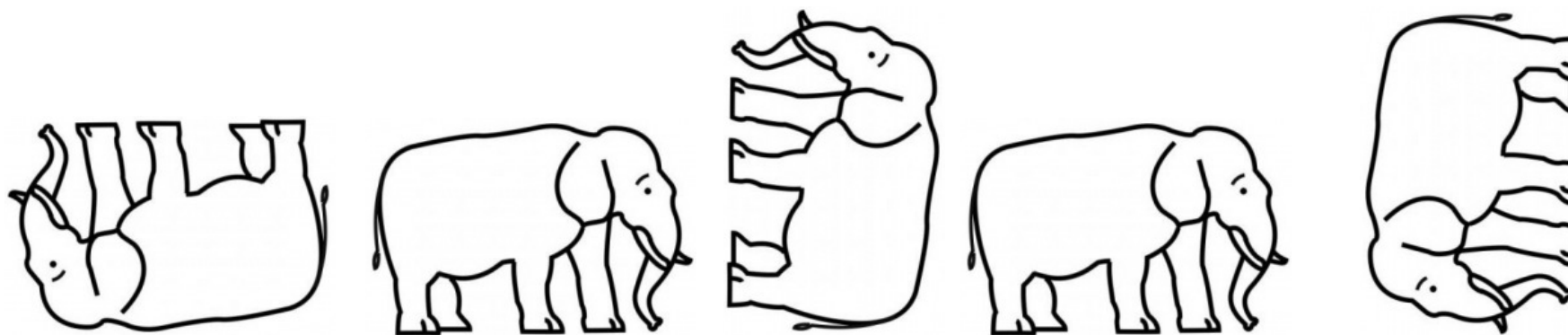
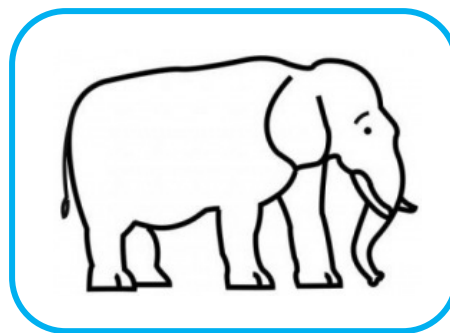





			
RODEA	LOS	ELEFANTES	IGUALES

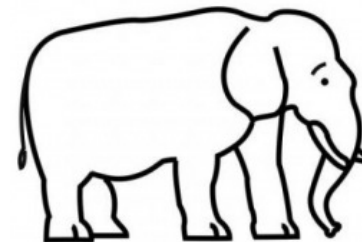
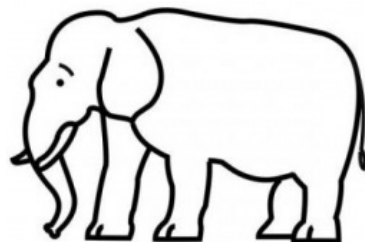
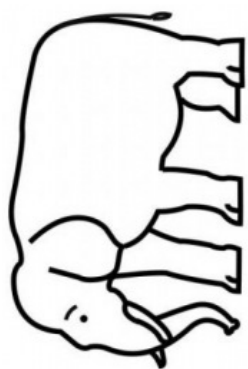
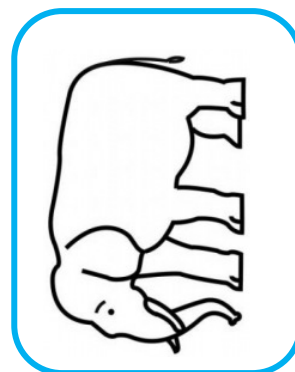

**Autor pictogramas:** Sergio Palao **Procedencia:** ARASAAC <http://catedu.es/arasaac/> **Licencia:** CC (BY-NC-SA)  
**Autora:** Amaya Padilla Collado <http://www.garachicoenclave.blogspot.com>



			
RODEA	LOS	ELEFANTES	IGUALES



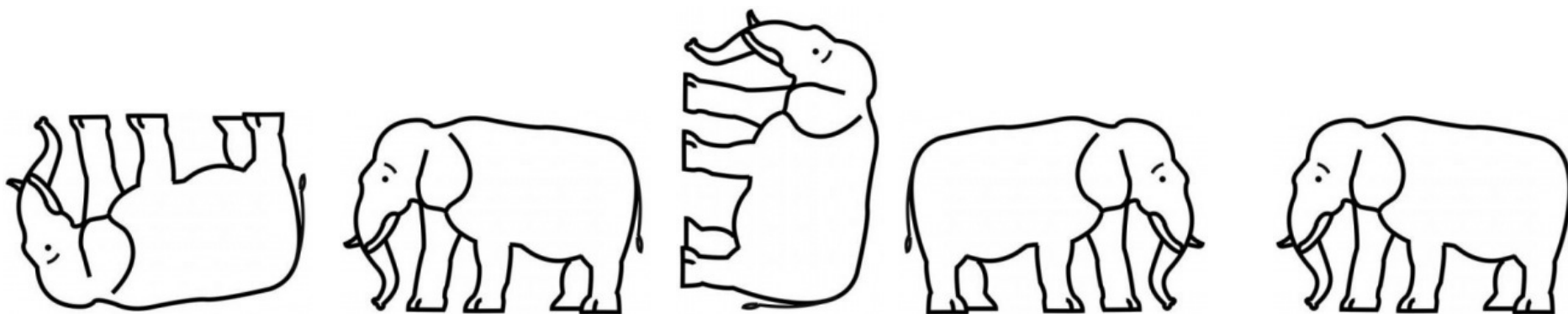
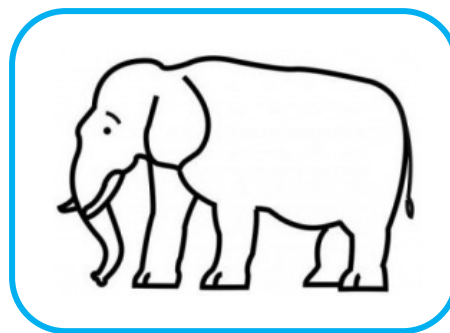



			
RODEA	LOS	ELEFANTES	IGUALES

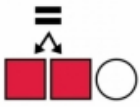

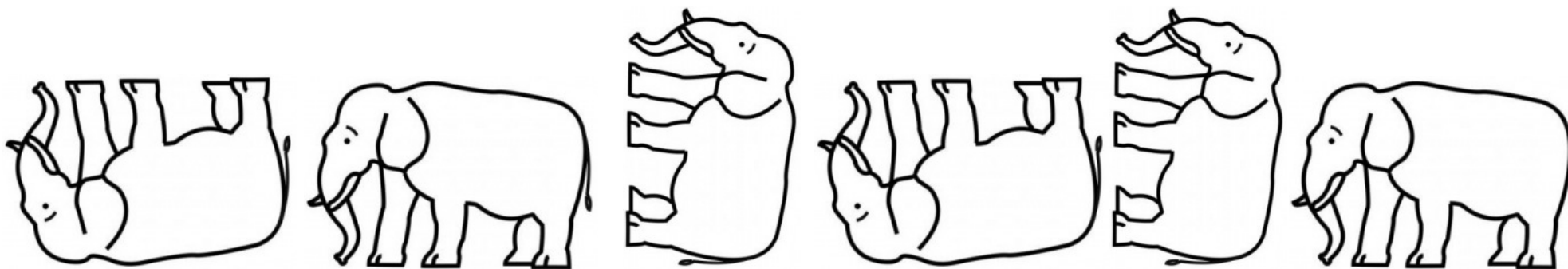
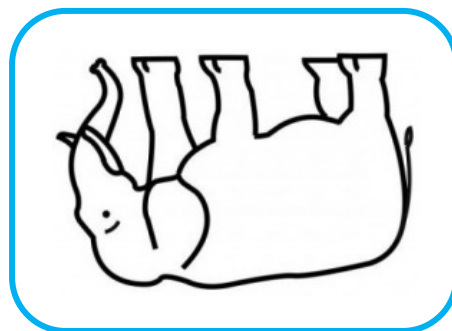

			
RODEA	LOS	ELEFANTES	IGUALES

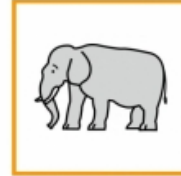

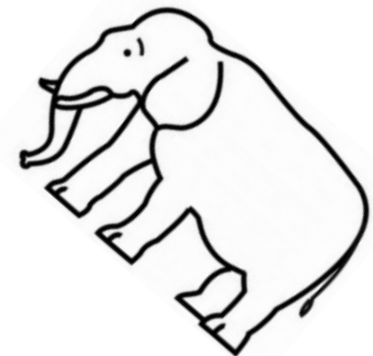
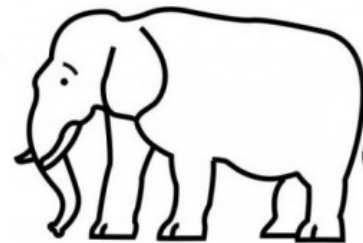
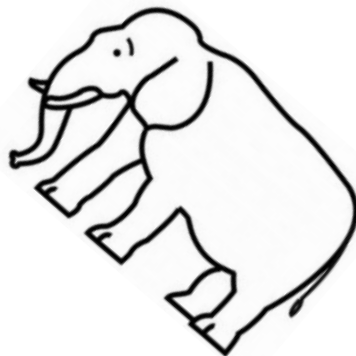
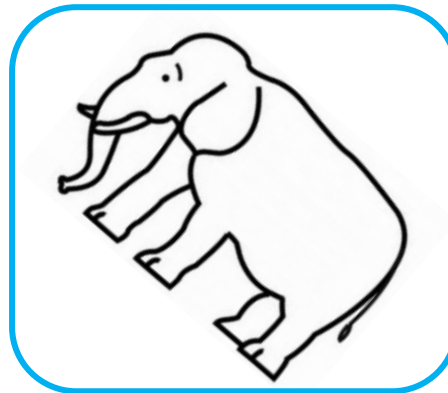

			
RODEA	LOS	ELEFANTES	IGUALES

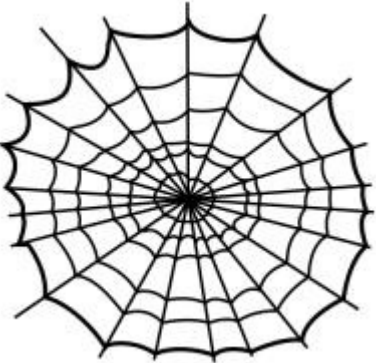
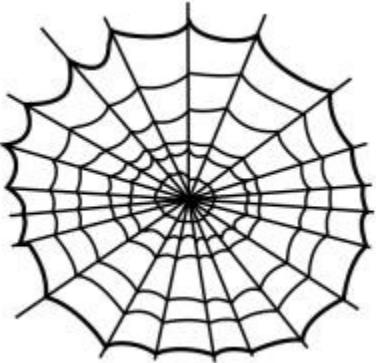

					
CUENTA	CUÁNTOS HAY	Y	ESCRIBE	EL	NÚMERO

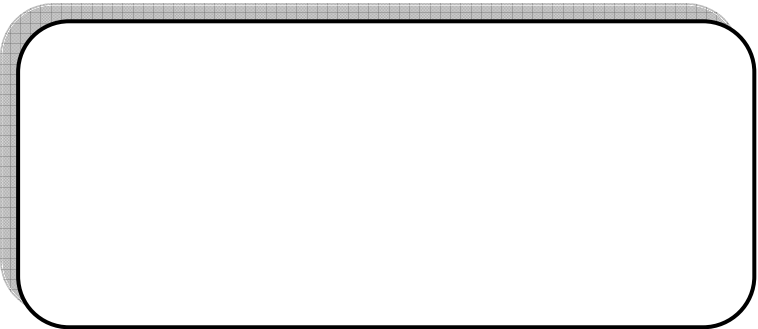







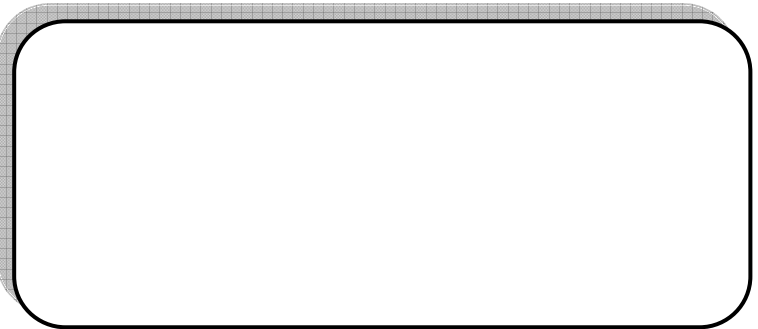

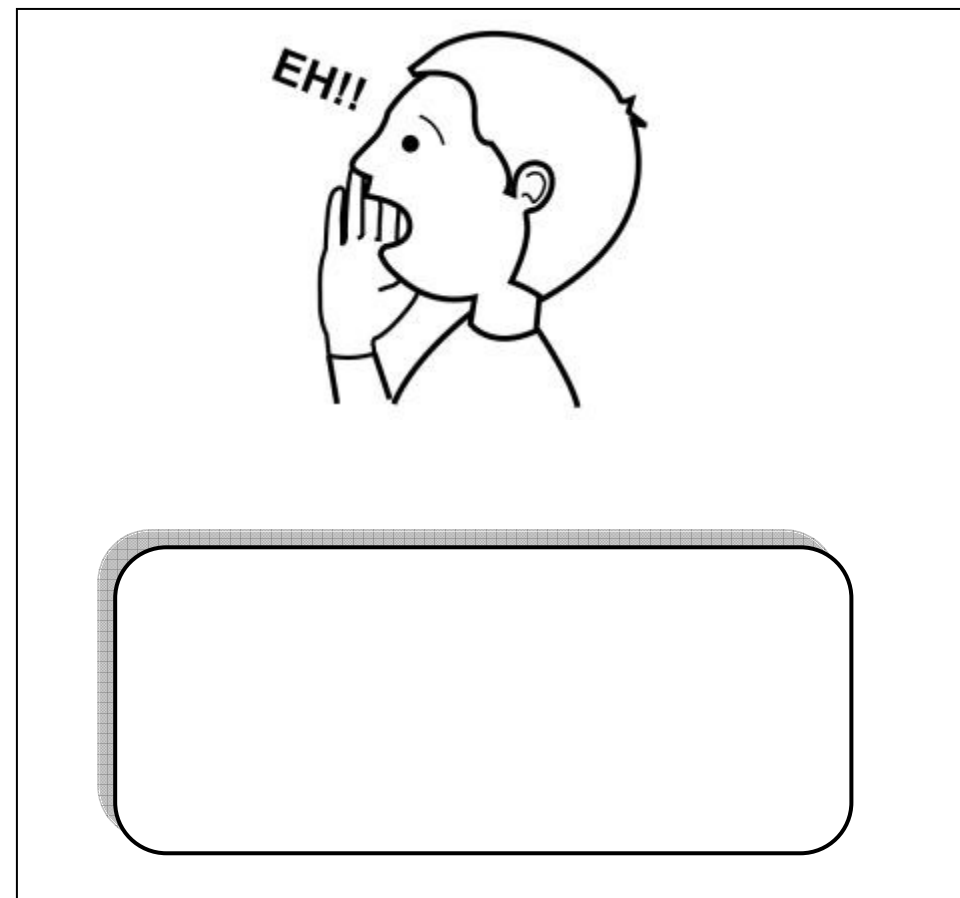
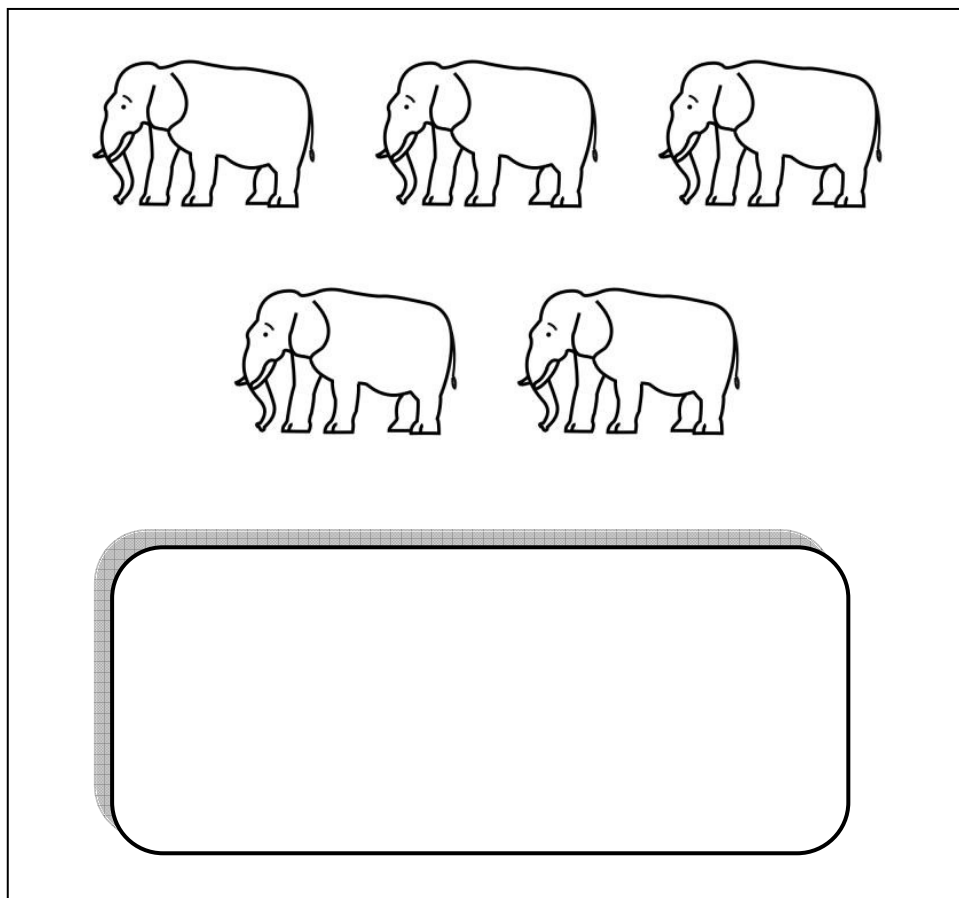





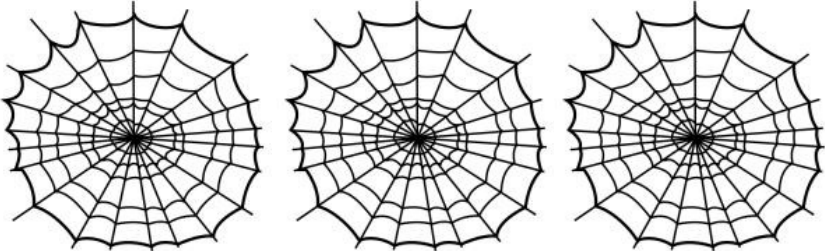

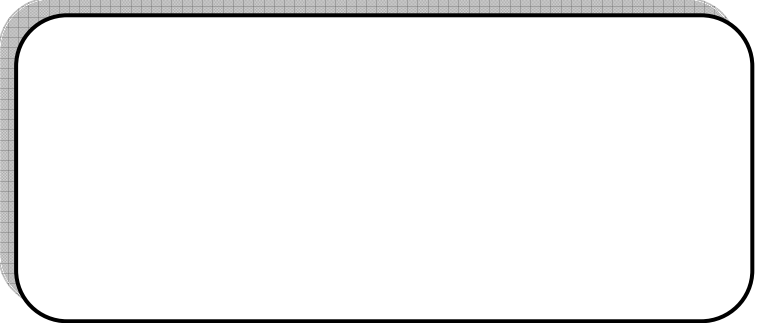

					
CUENTA	CUÁNTOS HAY	Y	ESCRIBE	EL	NÚMERO

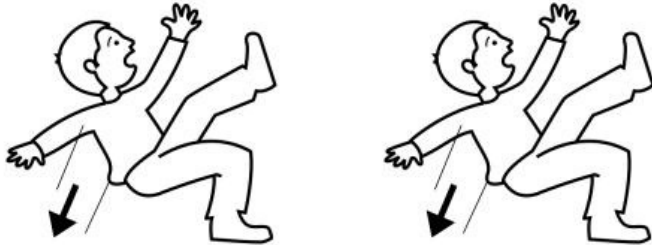

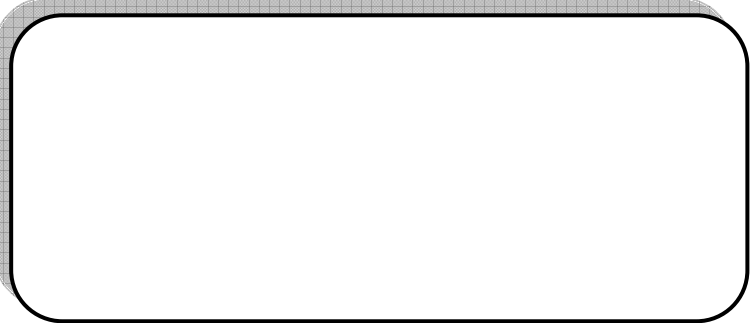







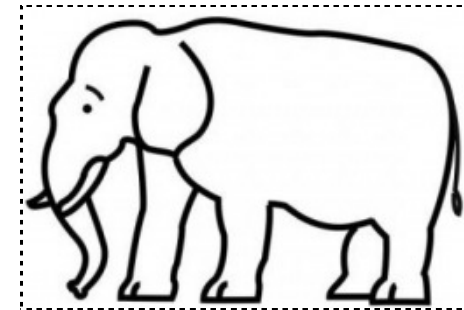
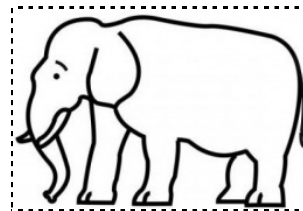
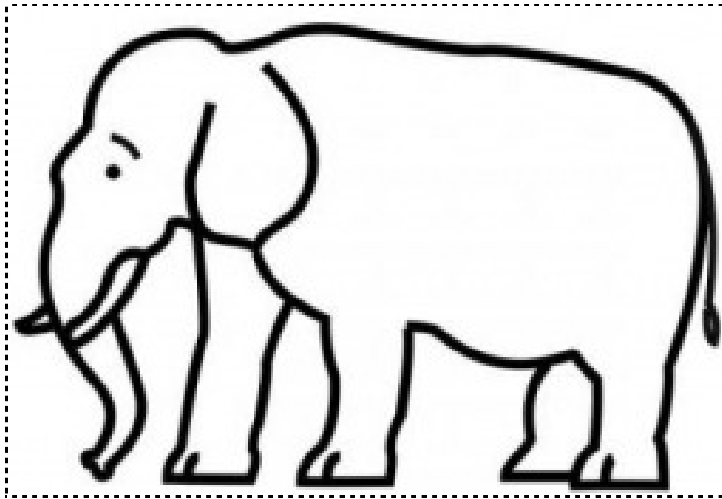

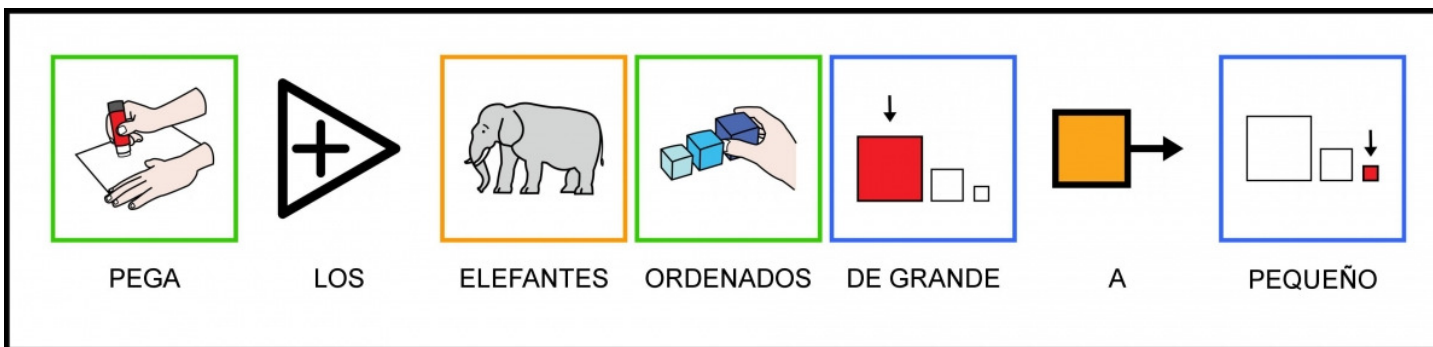
		
RECORTA	LOS	ELEFANTES





		
RECORTA	LOS	ELEFANTES

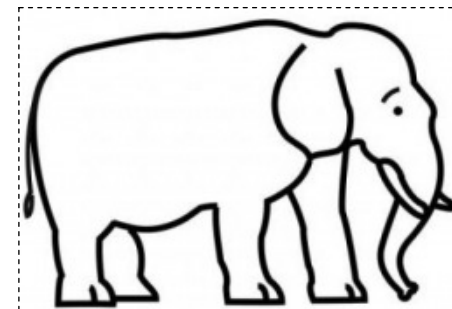
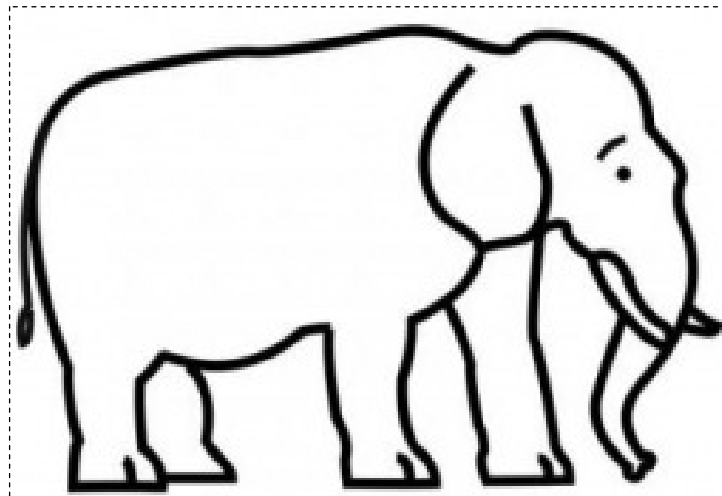
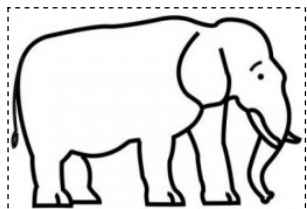



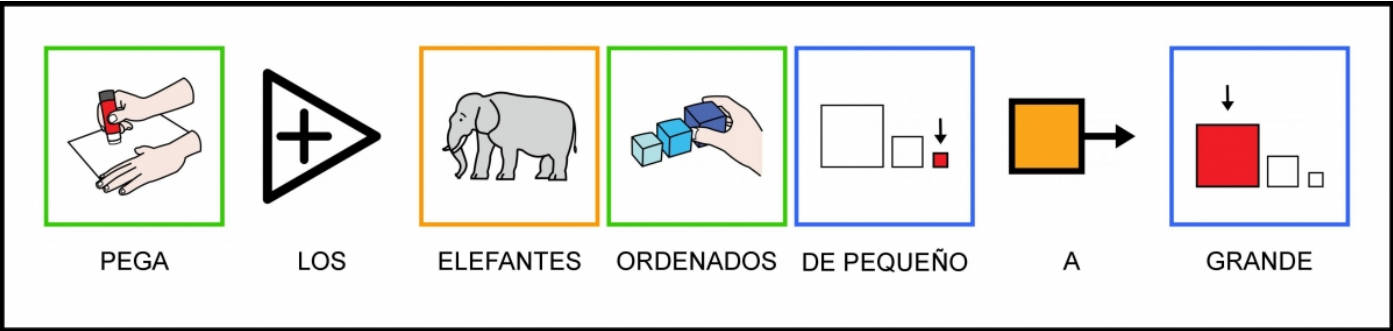

**Autor pictogramas:** Sergio Palao **Procedencia:** ARASAAC <http://catedu.es/arasaac/> **Licencia:** CC (BY-NC-SA)  
**Autora:** Amaya Padilla Collado <http://www.garachicoenclave.blogspot.com>



UNO



UNO

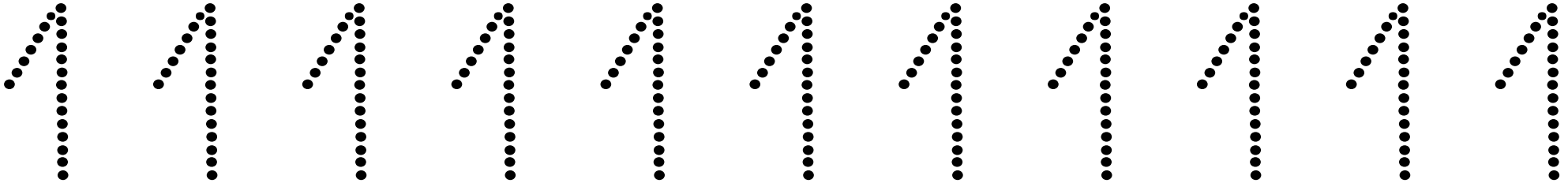



DOS

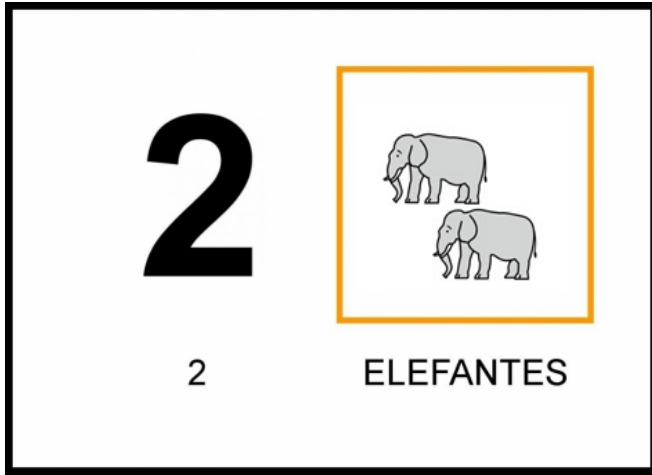

DOS

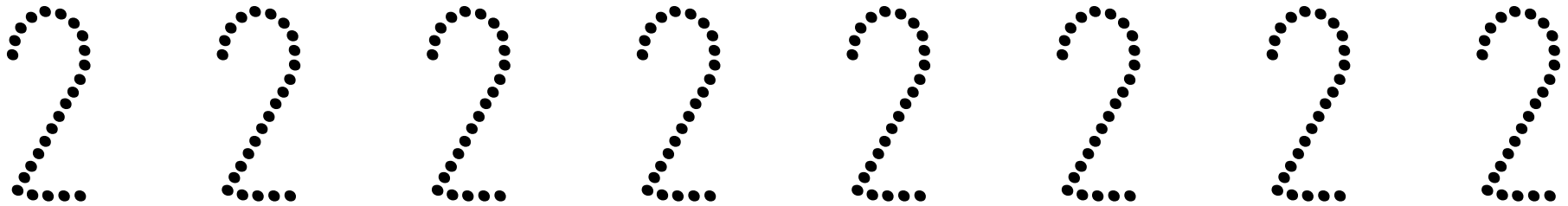



TRES

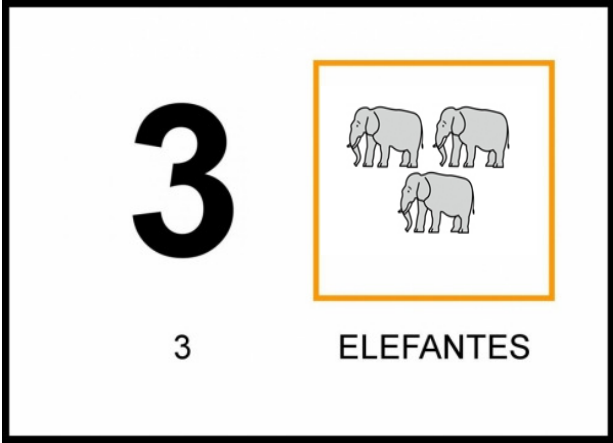

TRES

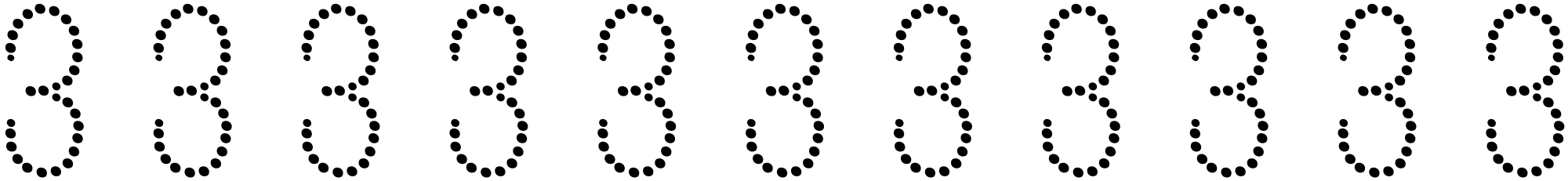



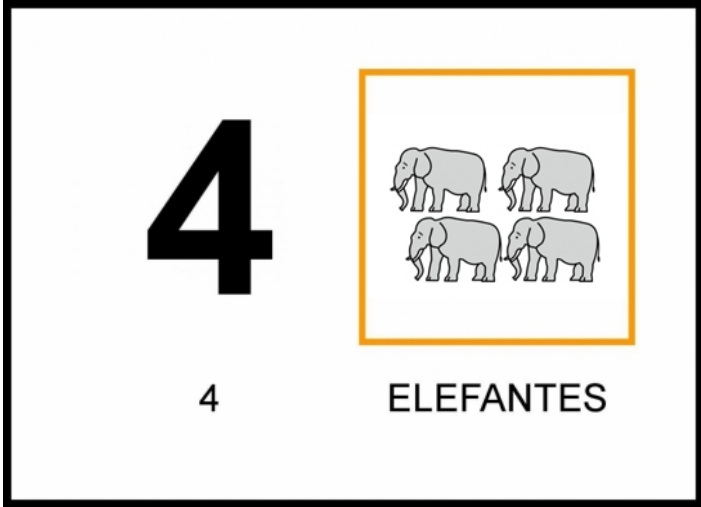

CUATRO

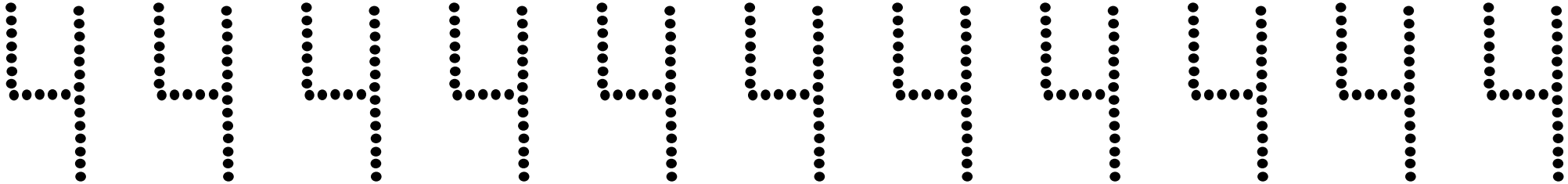

CUATRO

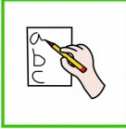

		
LEE	Y	ESCRIBE

CINCO

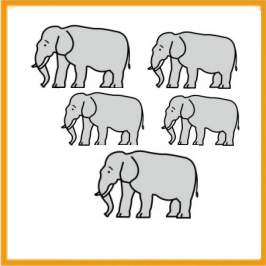
	
5	ELEFANTES

CINCO

5 5 5 5 5 5 5 5 5 5 5