

C.E.T.P.
Raquel
Camacho

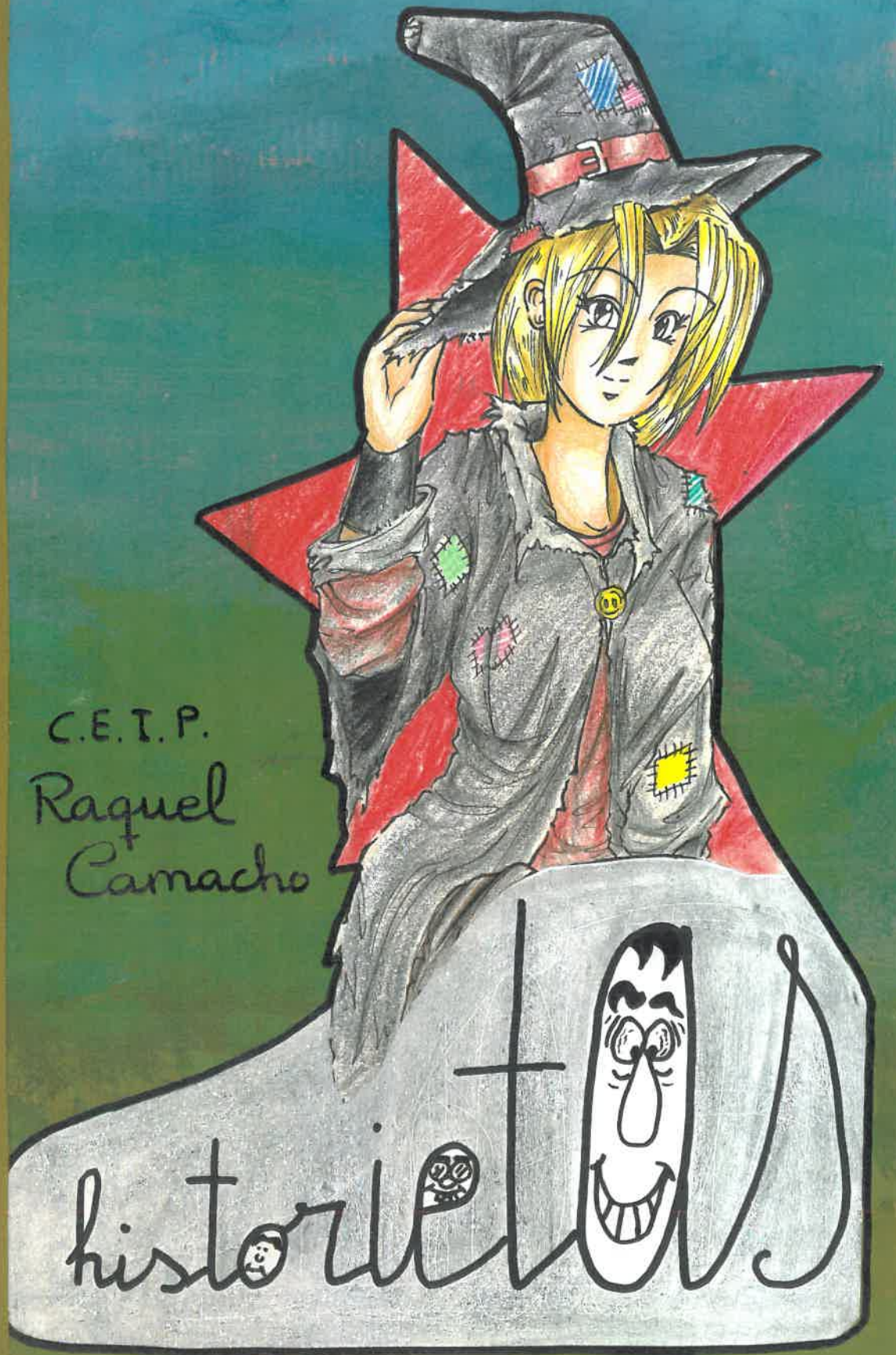

Nº 2

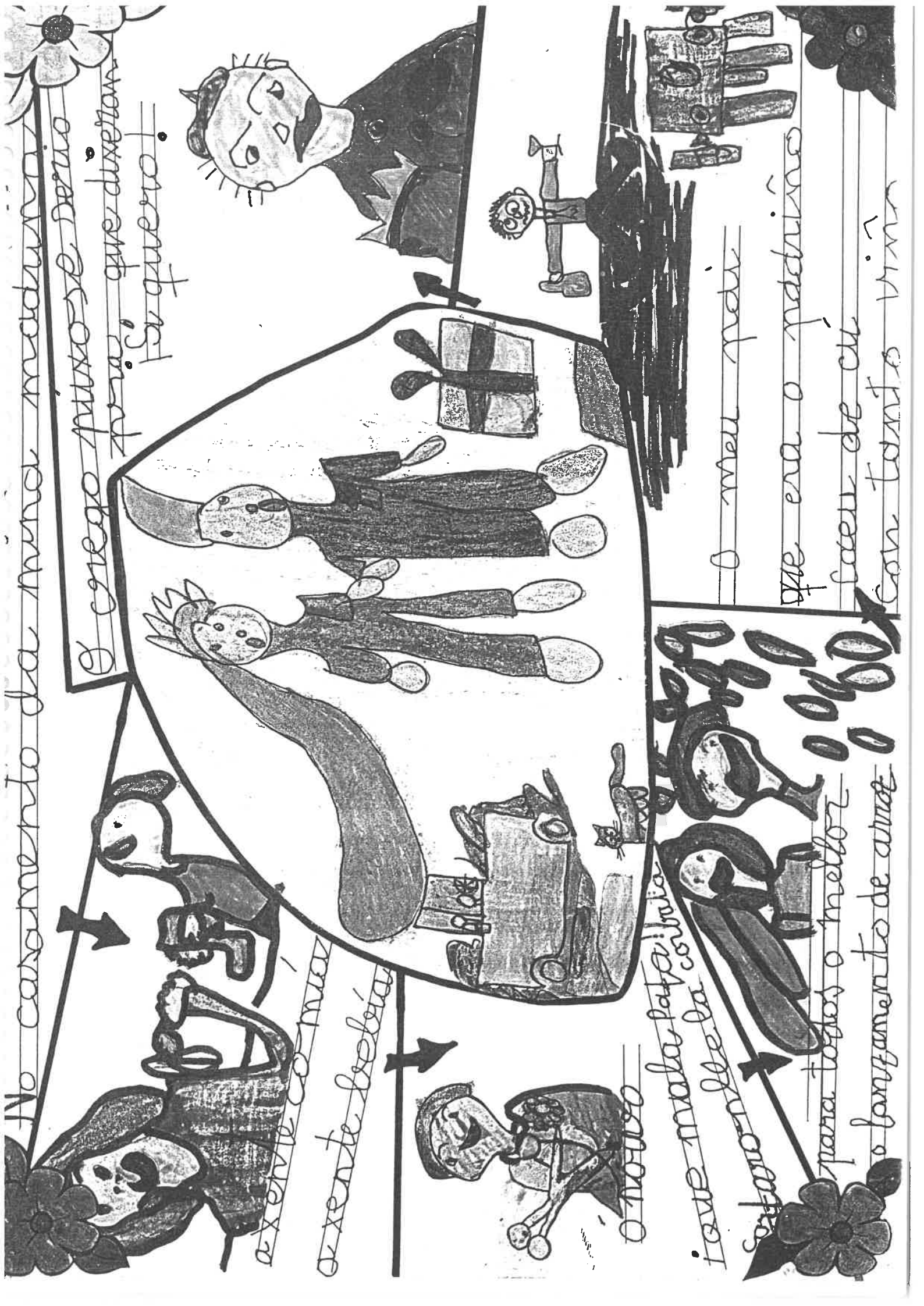

No casamento da minha madrinha

O cego ficou se deixo
fora, que dixeram
sa quero!

axente co mar

axente bebia

O noivo

foi mala pa cubria
sabe m le la

sabam le la

para todos o melhor
o casamento de avos

O meu pai

que era o padrinho

saer de cu
com tanto vin

a casa os convidados

ESTUDO

que se frequent

repetiram

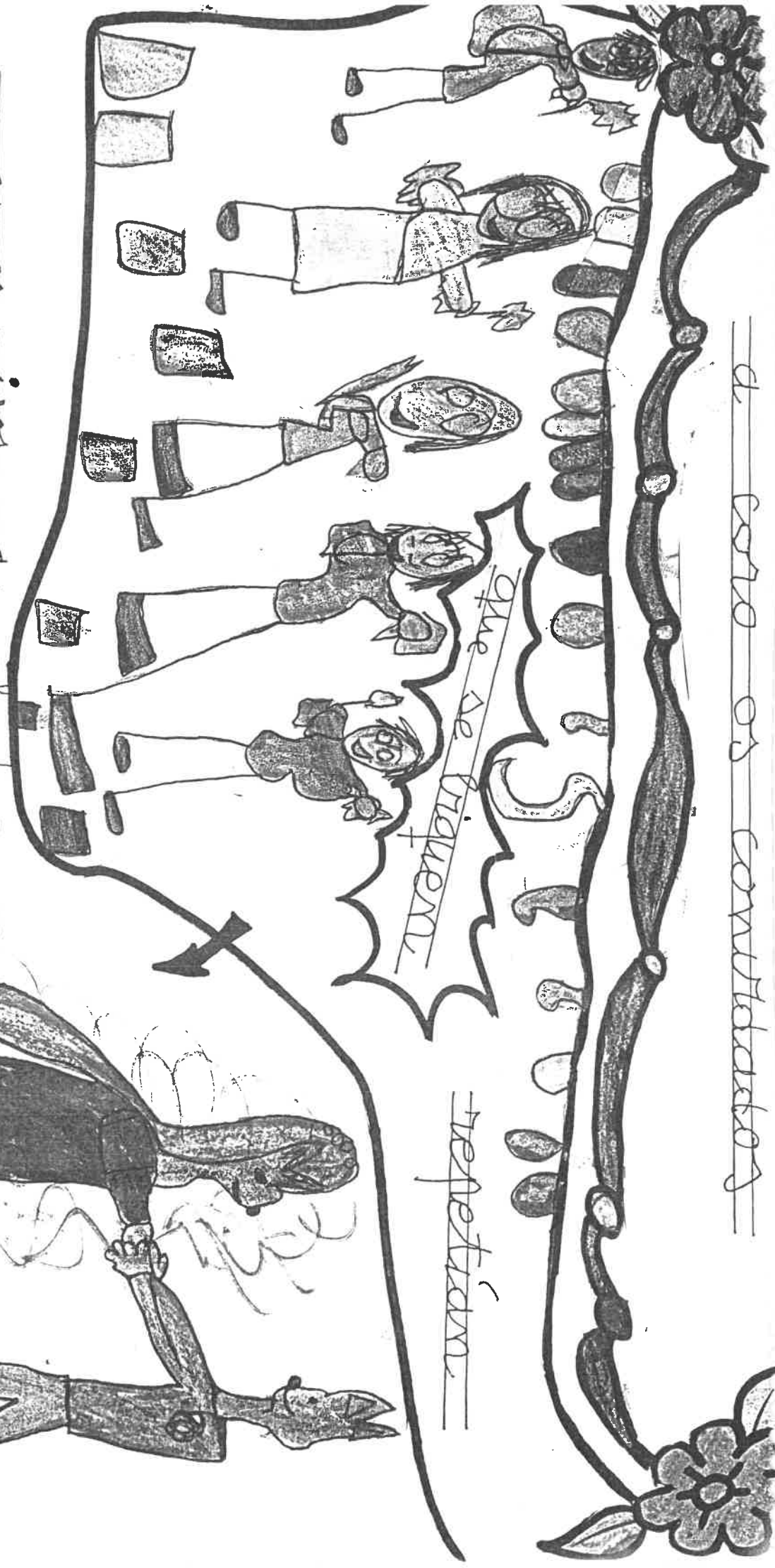

para os noivos convidados

social que por oam

Ed. Infantil

PARA BENS

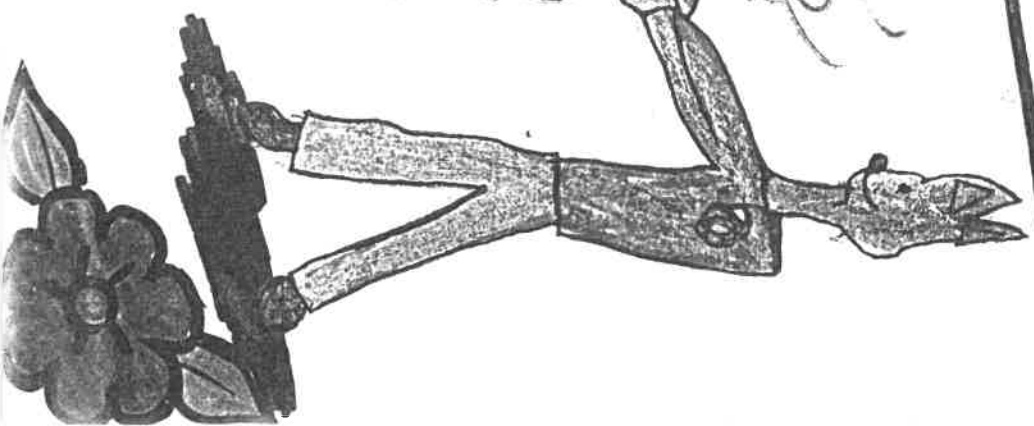

¡Mirade,
unha espiga
de millo!

¡Que
bonita!

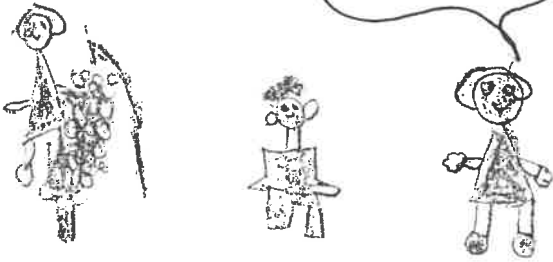

¡Vemos
sementa - los
grans.

¡Como mola
mete - las mans
na terra!



¡Bótalle
auga!

¿Dalle ben
o sol?

Xa.

Si.



¡Velaí
están as
pranti-
ñas

¡Que
pequeni-
ñas!

¡Viva!

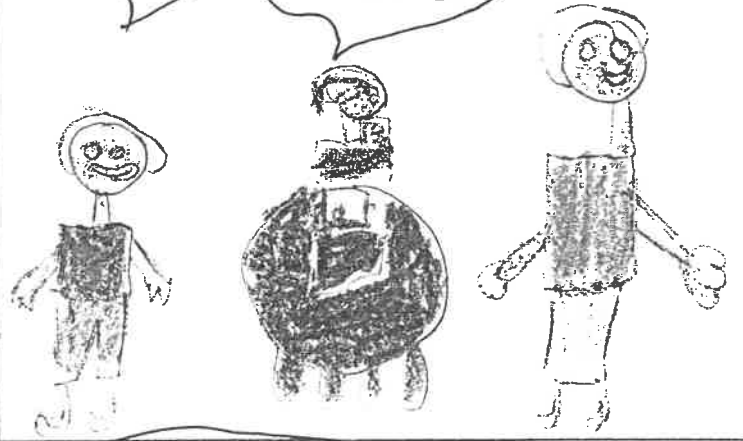

Xa
medraron
moito.

¡Son
verdes!

Si.



¡Viva as nosas
prantas

¡Temos
moitas

¡Viva!



— A SEMENTE —

¡Mirade,
unha espiga
de millo!

¡Que
bonita!



¡Mos
sementa - los
grans.

¡Como mola
mete - los mans
na terra!



¡Bótalle
auga!

¡Dalle ben
o sol?

¡Ka.

Si



¡Vela
están as
prantinas!

¡Que
pequeriñas!

¡Viva!



¡Xa
medraron
moito.

¡Son
verdes!

Si.

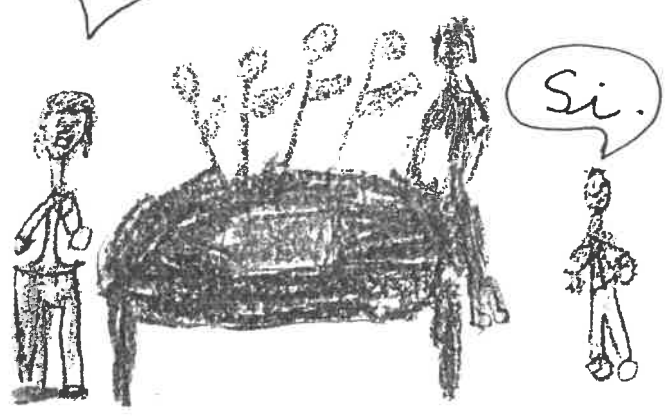

¡Viva as
nosas
prantas!

¡Femos
moitas.

¡Viva!



Marista

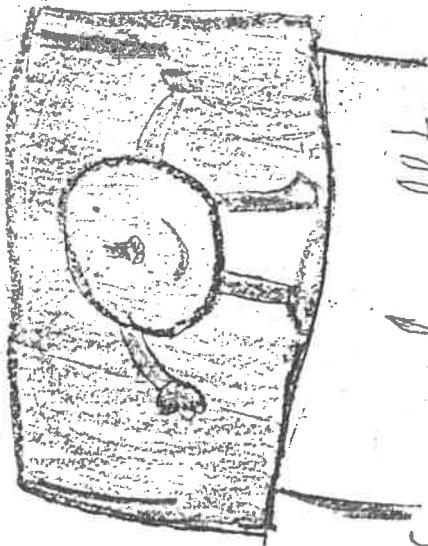

Érase unha galega
chamada Marista

a e a o u
1-2-3-4

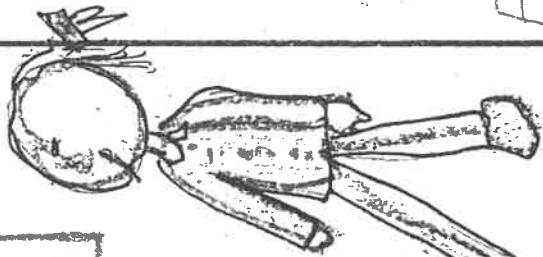

Marista aprendeu o
que a maestra dicía

PEPIÑO

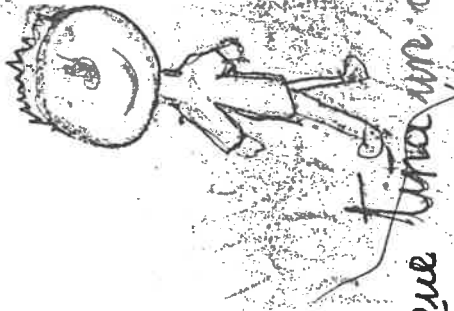

que tina un amigo
chamado Pepiño

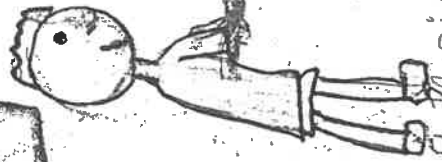
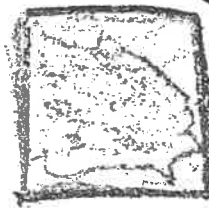

Ambaba a Pipiño
coz seus deberes

1B

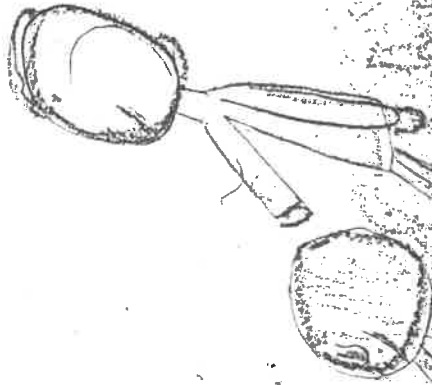

Os seus van á escola

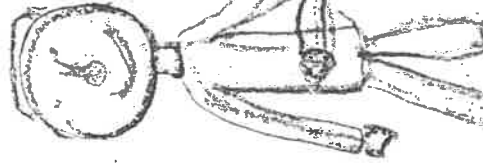

Os seus van á escola
coz deberes
mostrando
mostrando

O Coelho perdido - 2ª

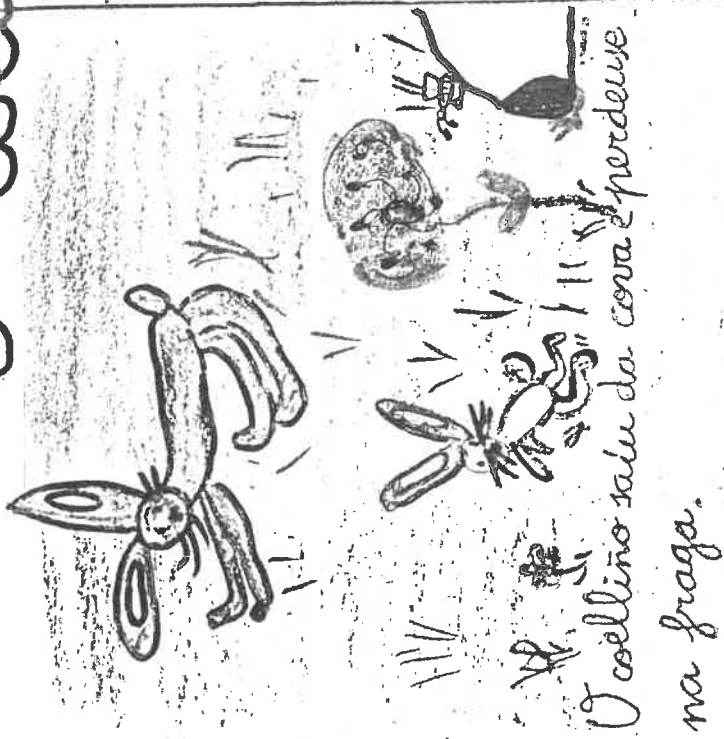

O coelho saiu da casa e perdeu na fraga.

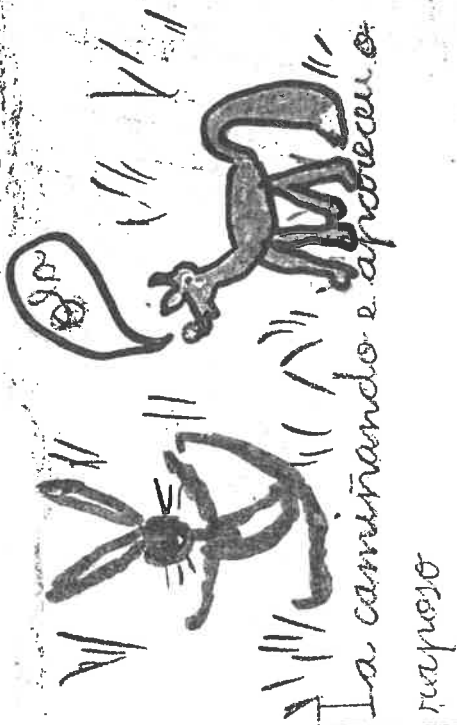

La caminhando e apreceu o traposo



O coelho ficou feliz, pero o traposo mono deixou

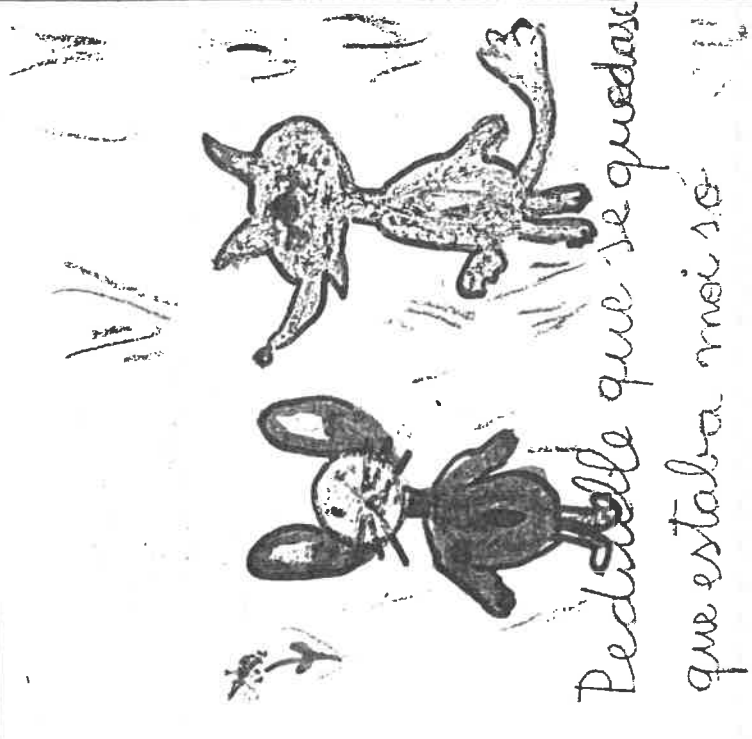

Pedribele que se quedase que estava moi so

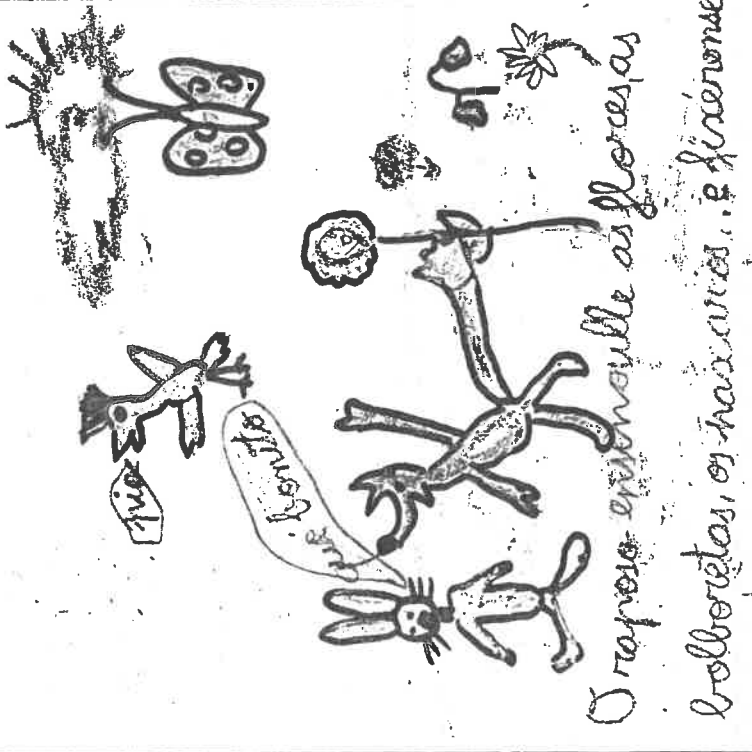

O traposo enroulle as flores as bolbetas, as haxuras... e finéronse

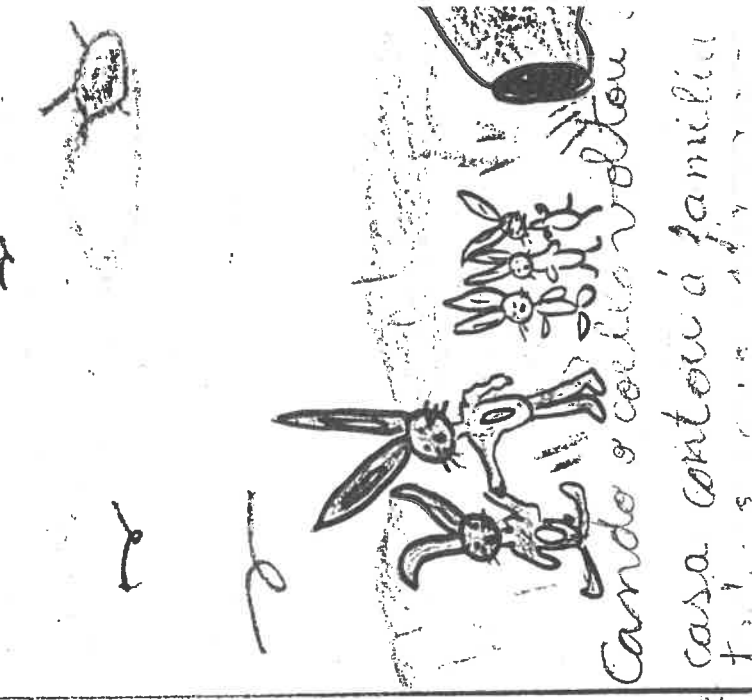

Quando o coelho voltou a casa contou a familia

A GRAN NUBE. 2ª



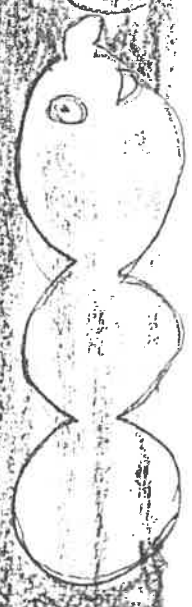

Erase unha MEU unha nube que
 estaba tam gorda que decidin
 botar unhas gotas.



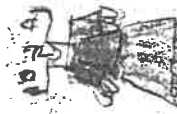

Queran as
 tres amigas

Non non

Non non
 que non

Non non
 que non

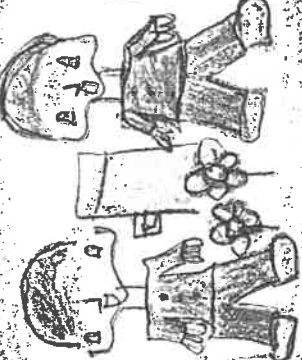

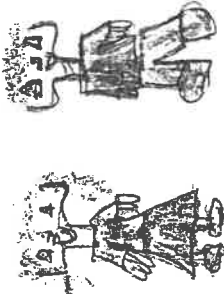
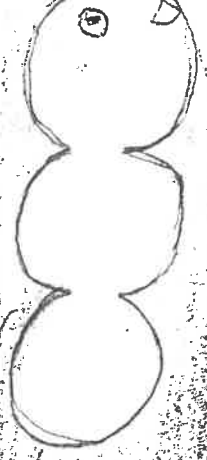

Non non
 que non

Non non
 que non

Seguin a
 nube

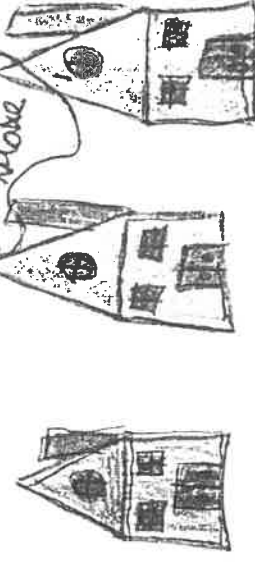
Seguin a
 nube



A ARDILLA ENTREVISTADORA. 2.ª A

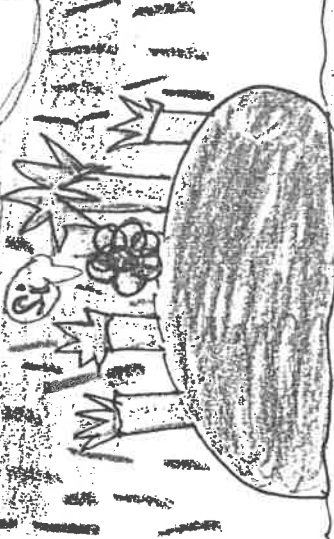

¿De qué lugar eres?

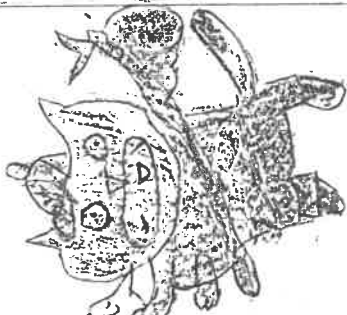

De la zona
lombia



¿Qué otras cosas no te caen bien?



Apartado no me caen bien.



¿Que le has no fardas?



No fardas le he traído algo de comida.



¿Por qué no me has traído nada?

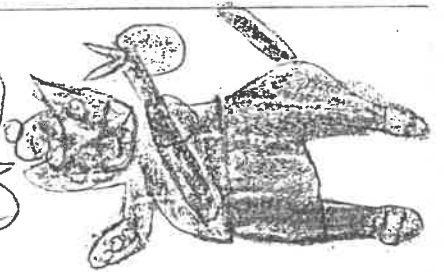

Ninguna, también me cae bien.



¿Cómo estás?

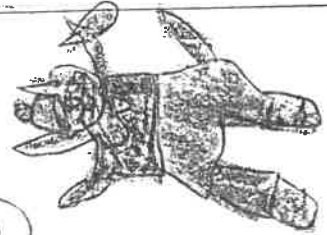

Me da maco con el campo de fútbol de la zona.

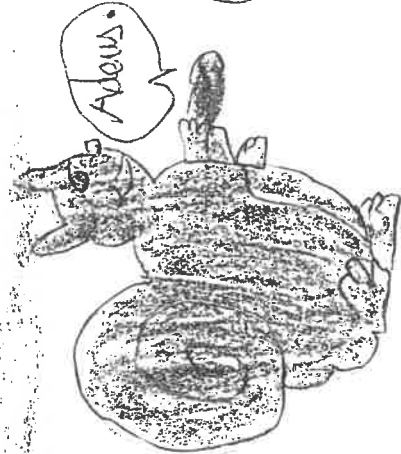

Además.

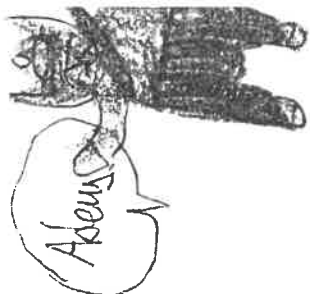

Además.

Unha mercenda na praia - 2º B 9/15 X

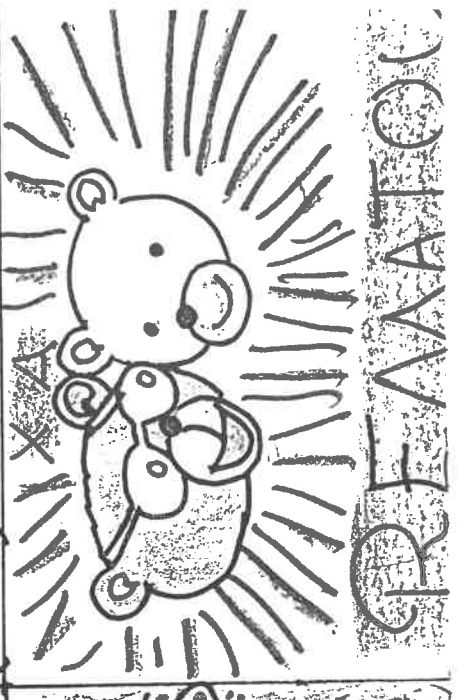
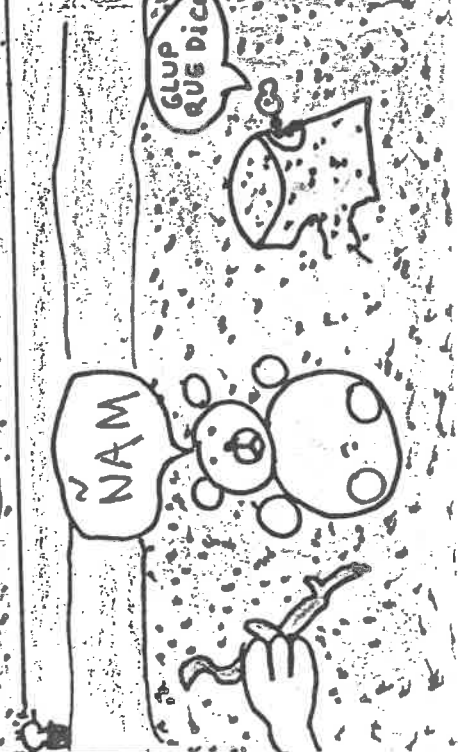
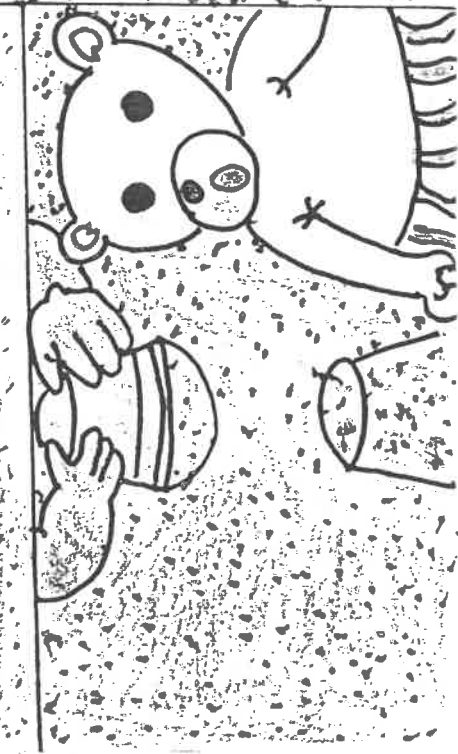
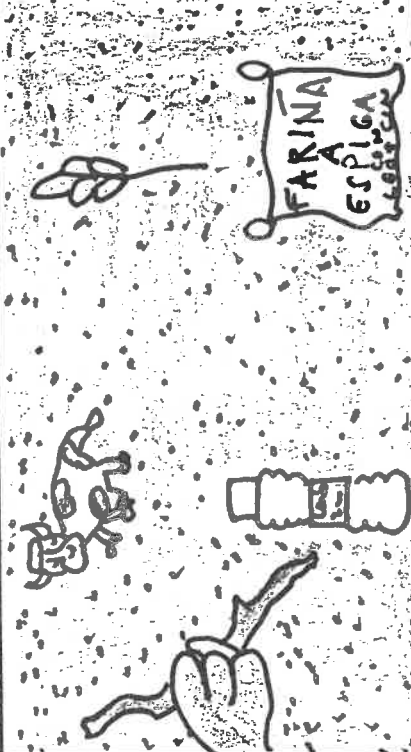
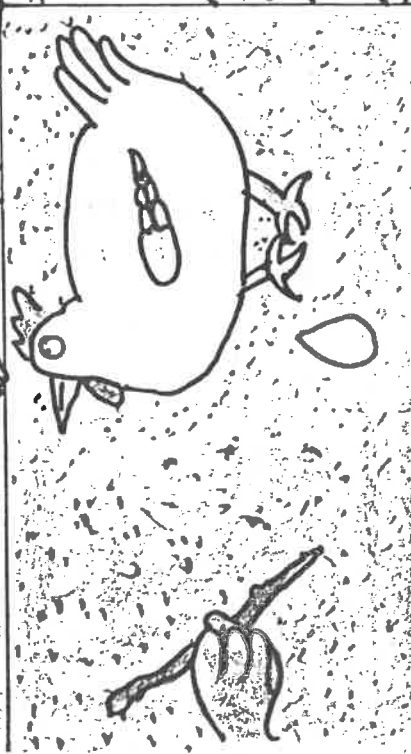
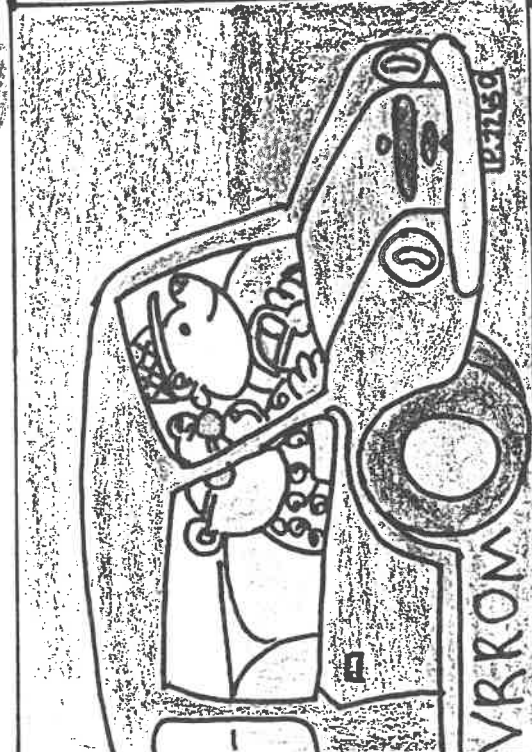

REFINATO

Uma merenda na praia - 2º B

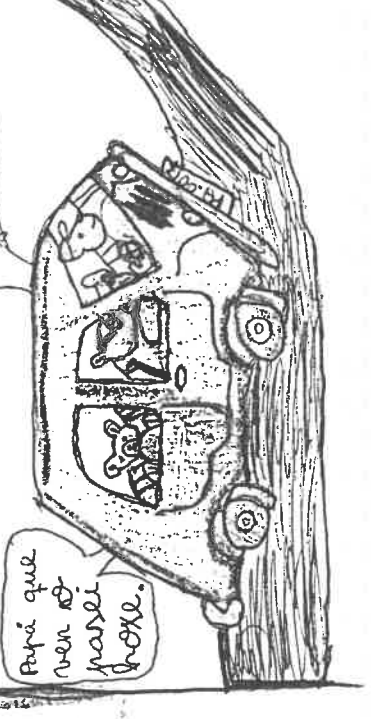
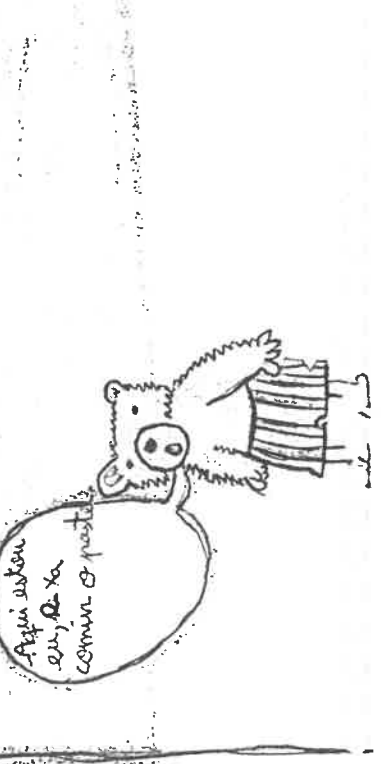
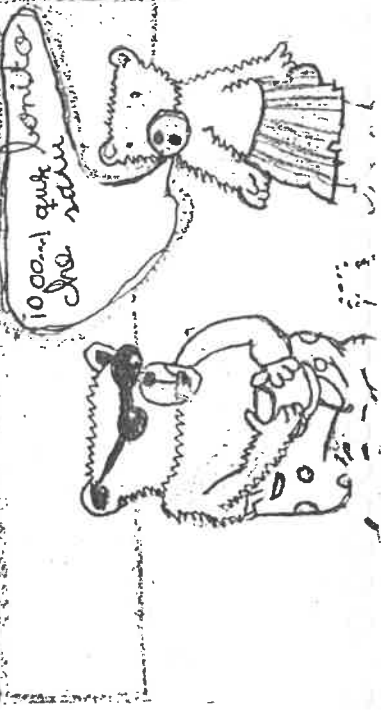
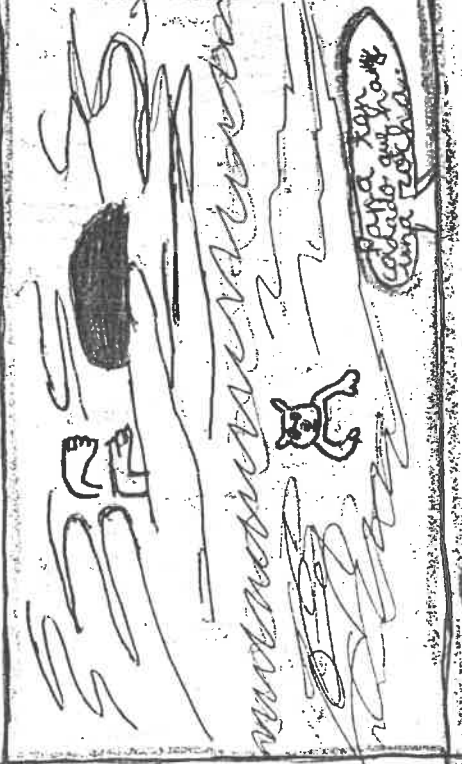
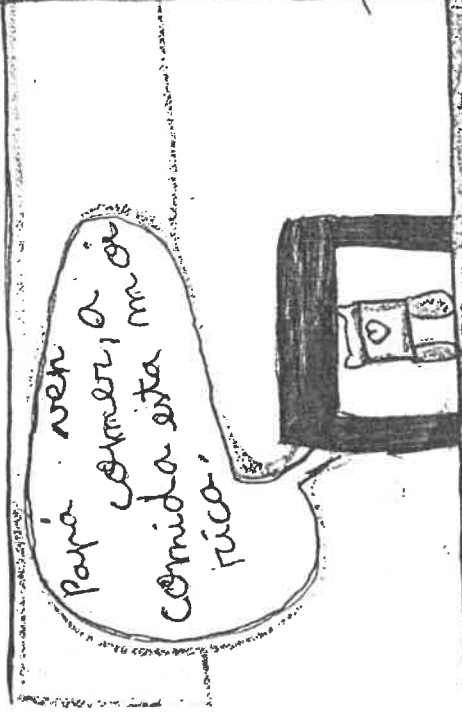
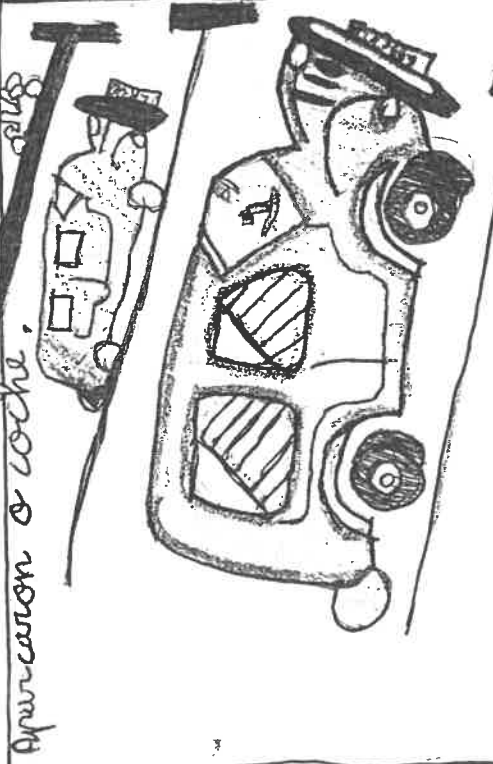
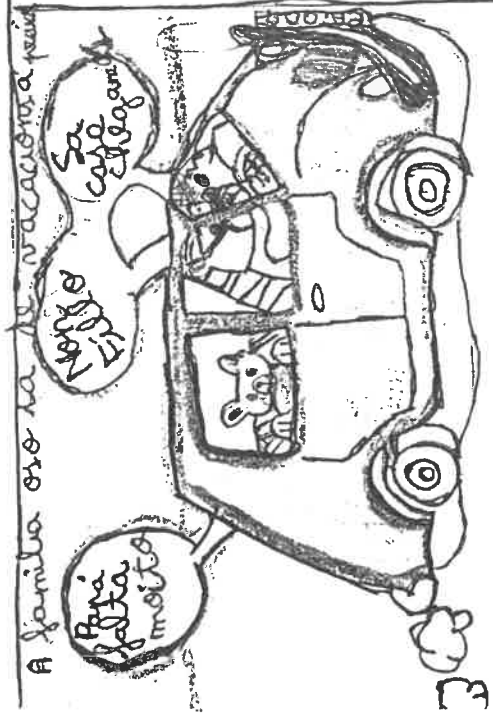

Vou dormir
um pouco
haber se
o gato tem
me desparar

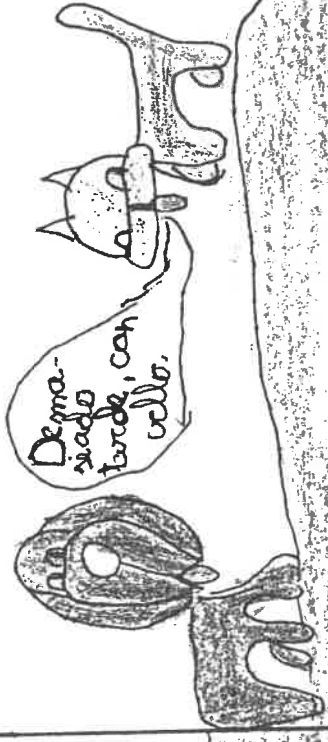
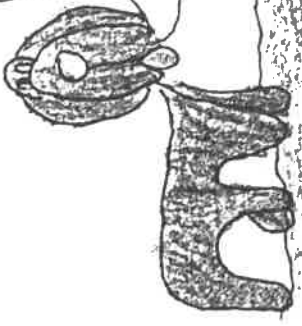

Demasiado
barulho, com
você.

Oh
nem vejo
a ton-
ta do
gato



Cala
te car-
rinhim.
Eu não
quero
calor.

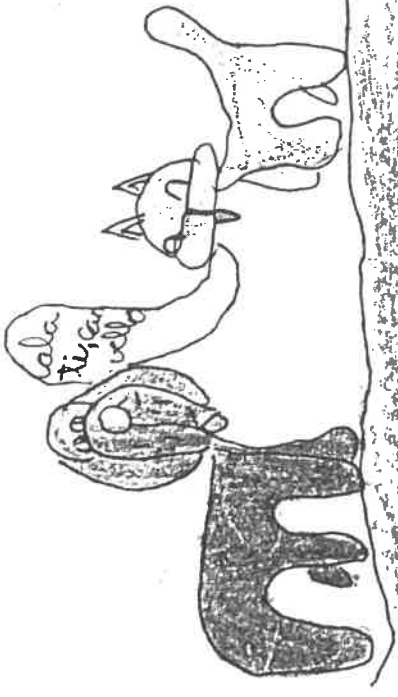
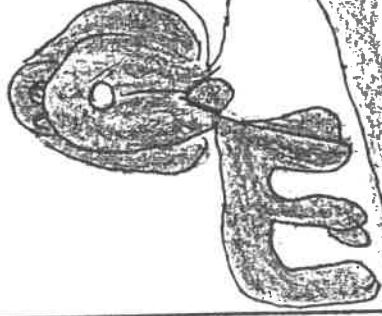

Cala
te, car-
rinhim

Fuza
me
ligo
go teu.

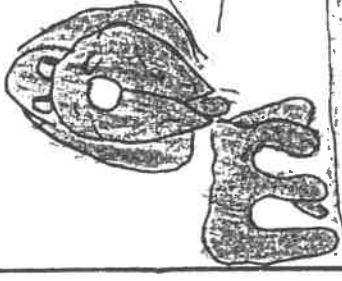

Fim

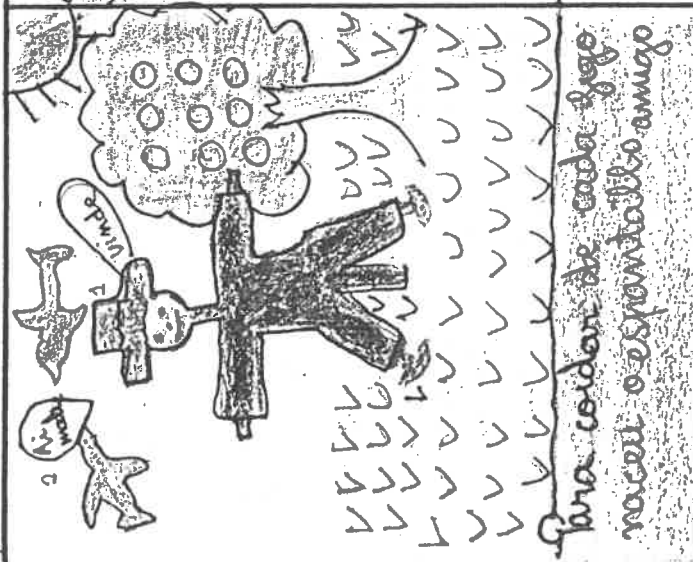

Para coidar de cada fogo
naceu o espantallo amigo

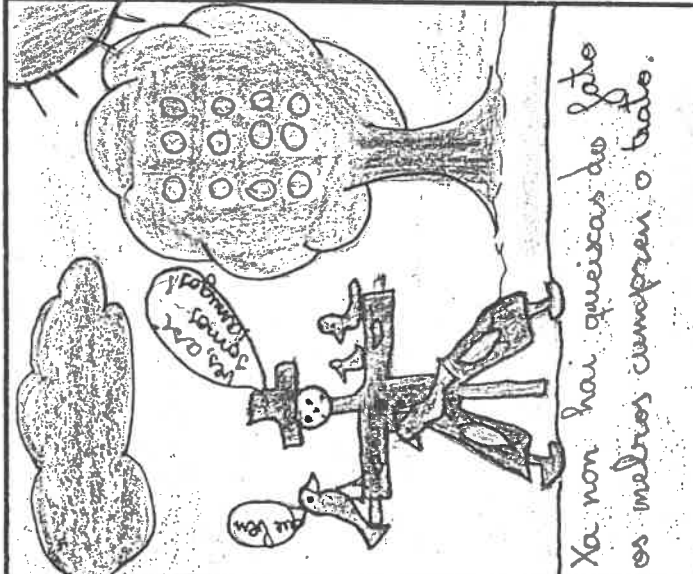

Xa non hai queixas do lato
es melros cumpren o trato.

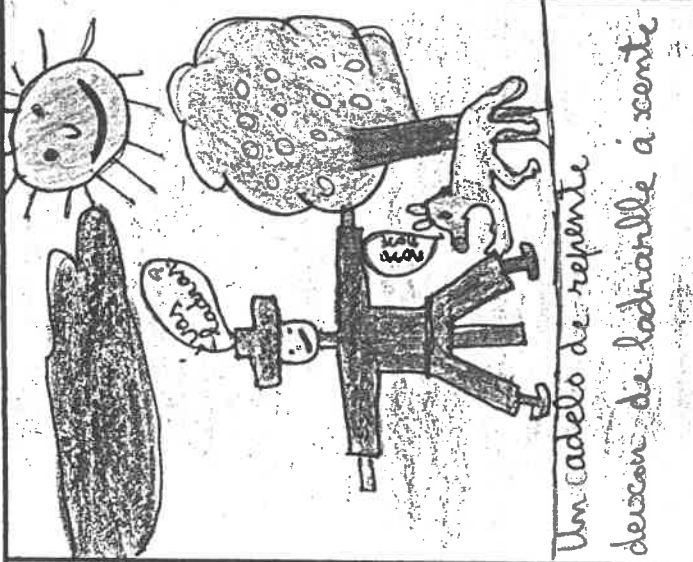

Um cadelo de repente
deixou de ladrarlle a conte

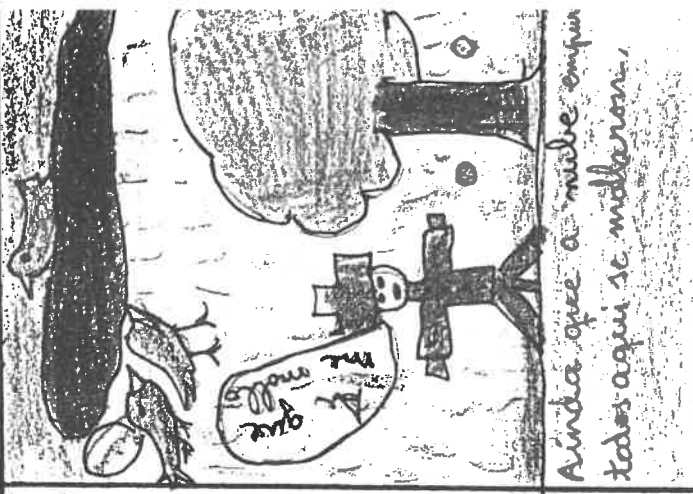

Ainda que a nube empurra
tados aqui se molloaron.

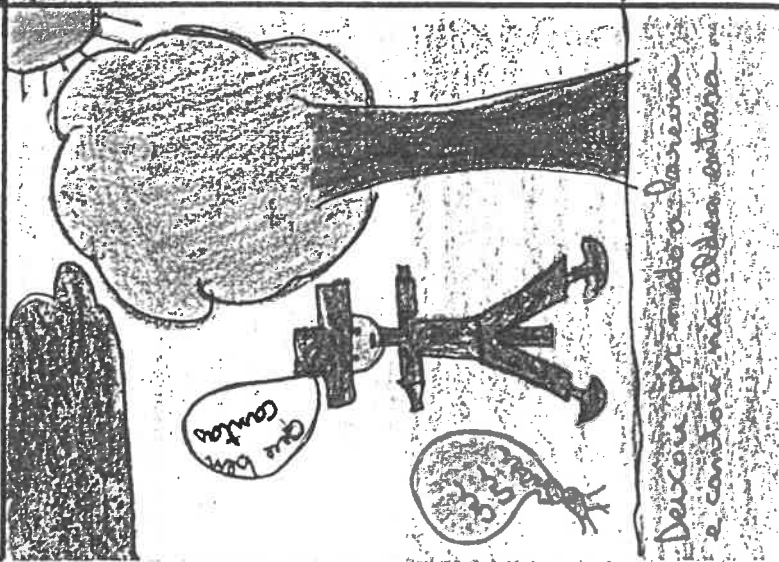

Deixou por malos barreira
e cantou na adusa anterior.

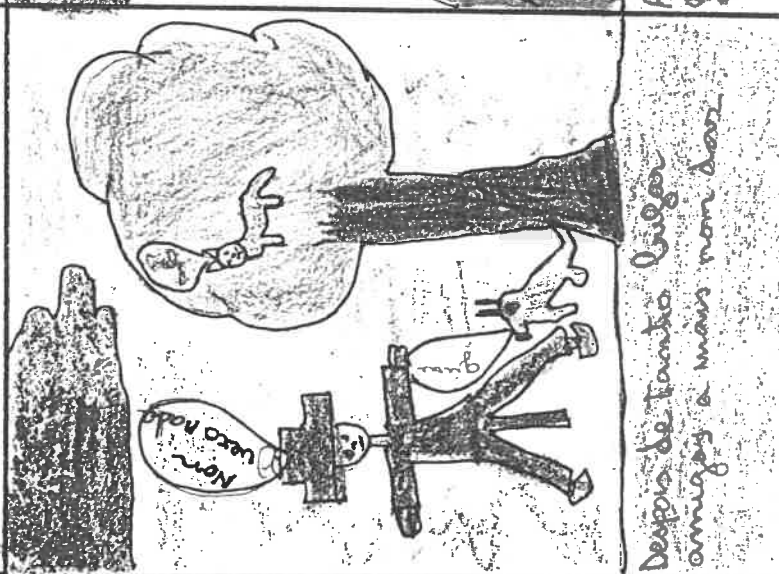

Despois de tanto bicho
amigos a mais non dar

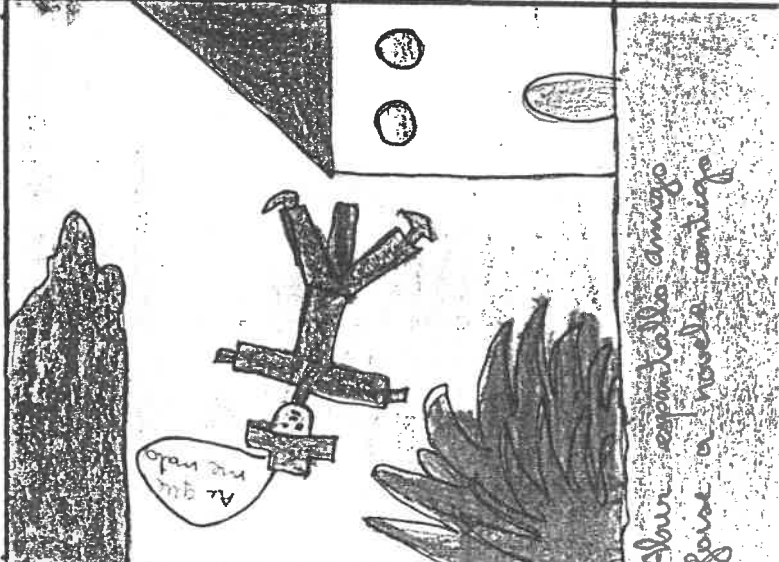

Abr espantallo amigo
foise a novela contigo

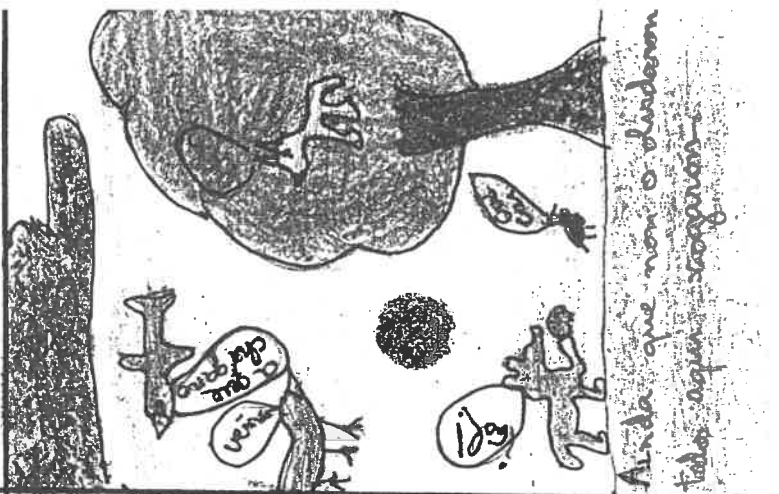

Ainda que non o chuderon
tados aqui traquen

ESPANTALLO AMIGO - 3ºA - Gema

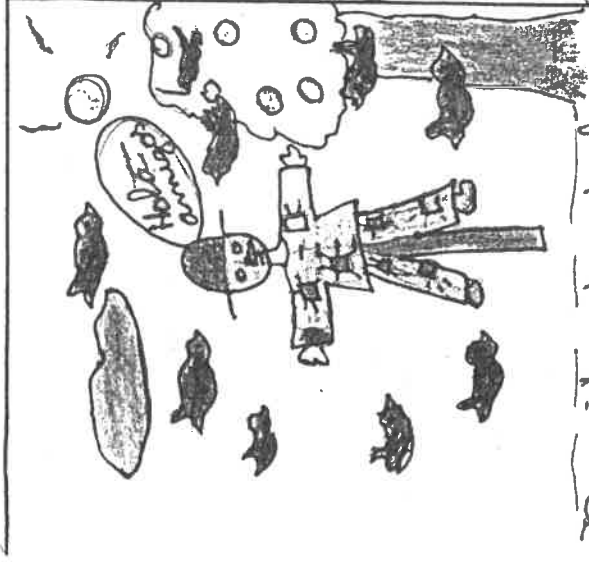

Para cuidar de cada figo na
ceu o espantallo amigo.

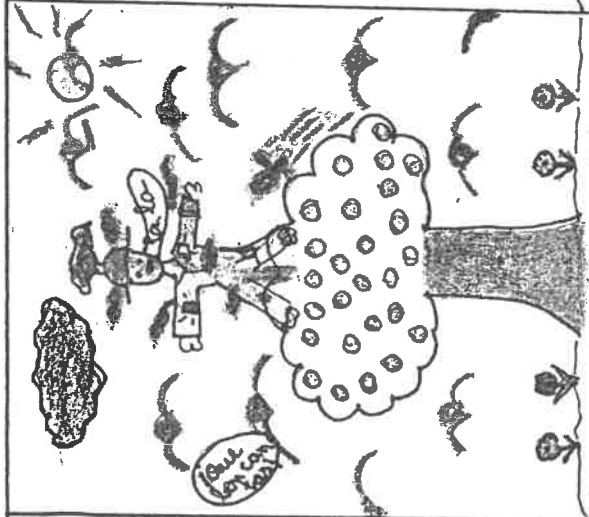

Ja non hai queixas do falo
os meigos ampuen o trato.

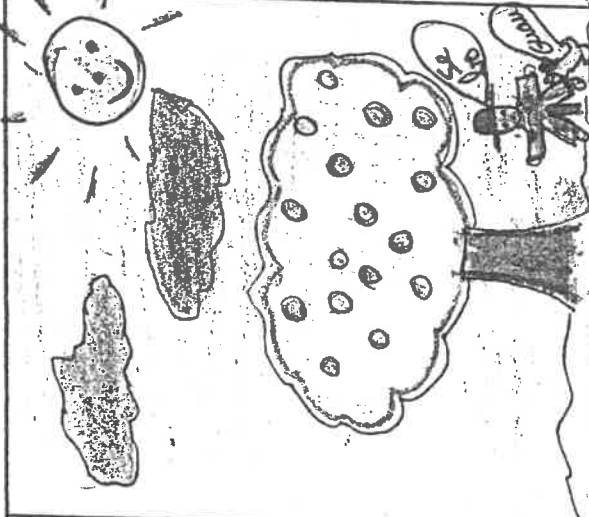

Um cadelo de repente
deixou de labrallar e cente

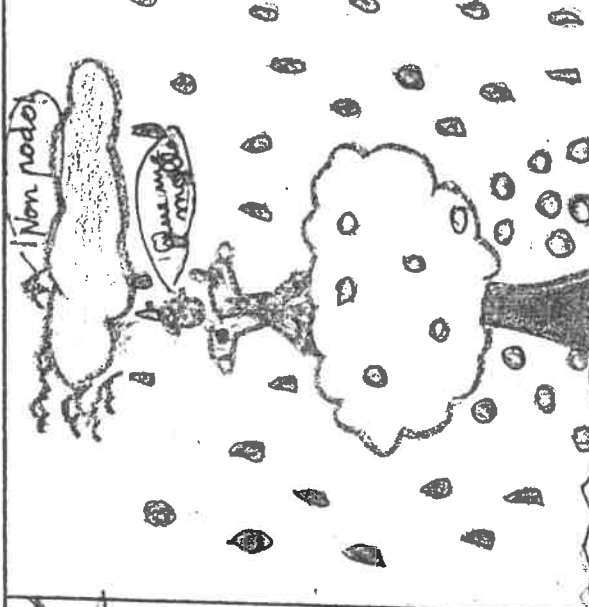

Ainda que a miña empuraron
todas aqui se mollaron

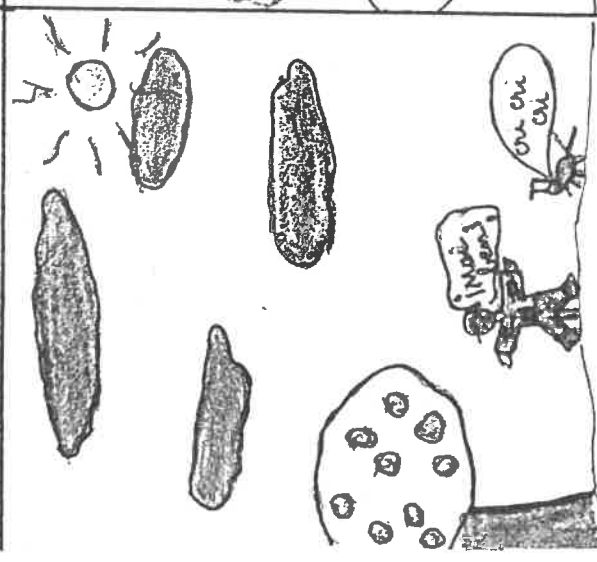

Deixou por medo a lavera
e cantou na aldeia enteira.

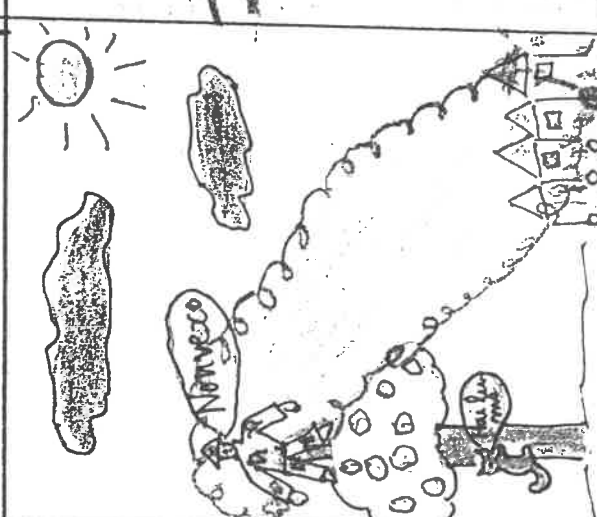

Depois de tanto bufar
amigos a mais non dan.

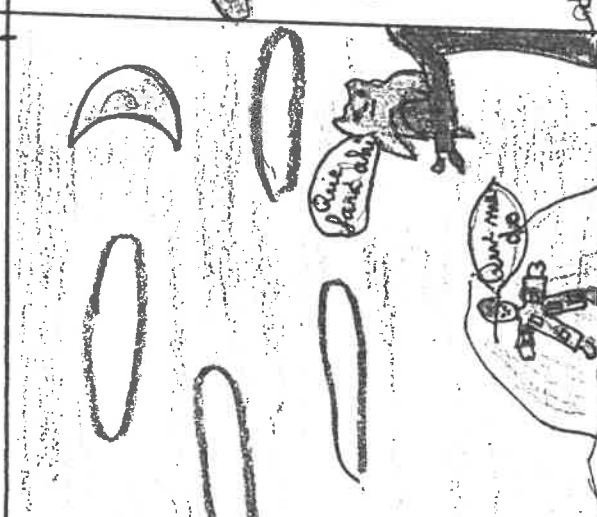

Abur, espantallo amigo
foxe a novela contigo

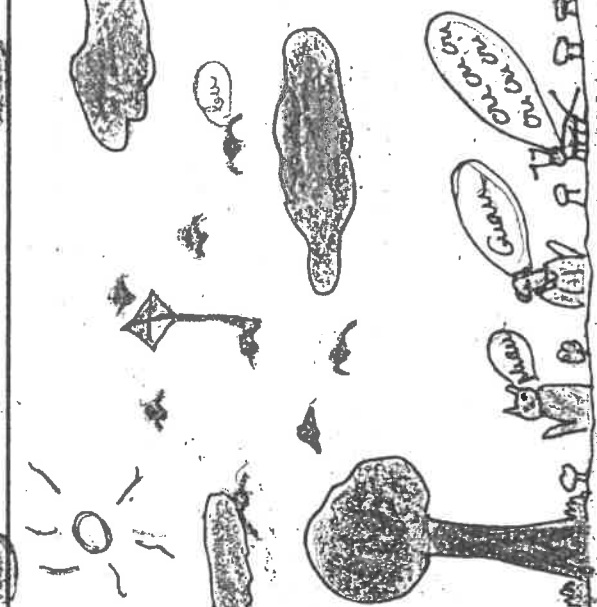

Depois de tanto chorar
puséronse a reigar.

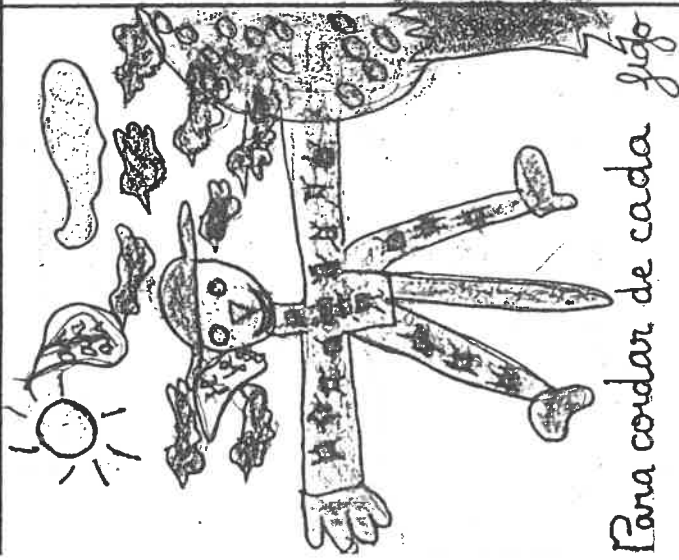

Para cordar de cada figo

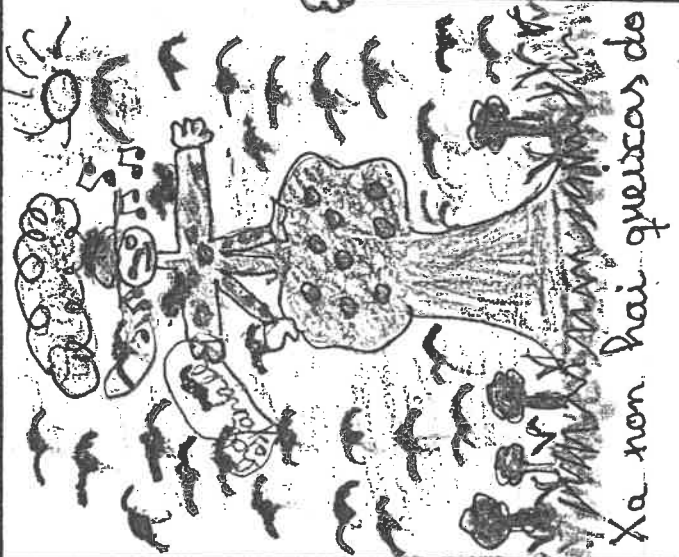

Xa non hai queixas do

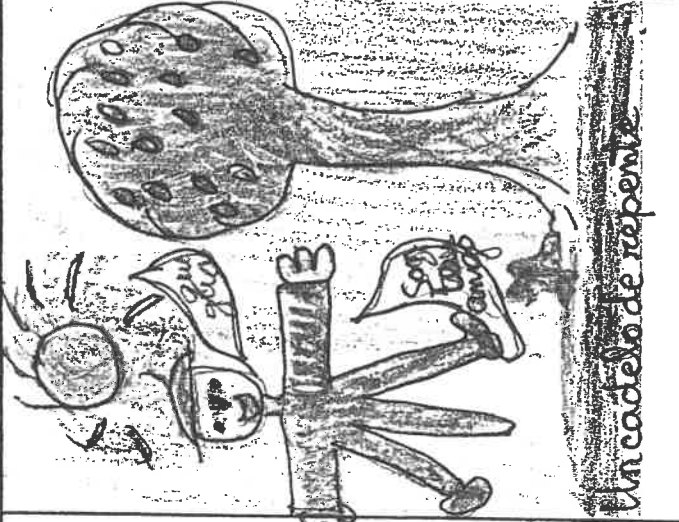

Un cado de repente

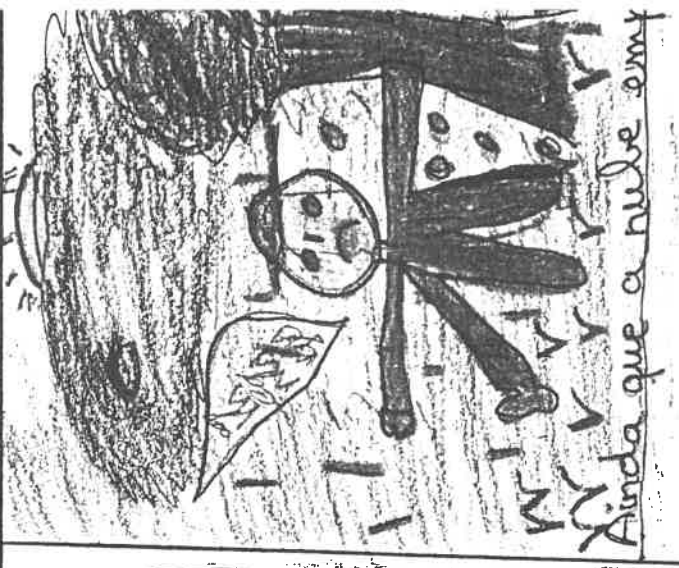

Ainda que a nube emy

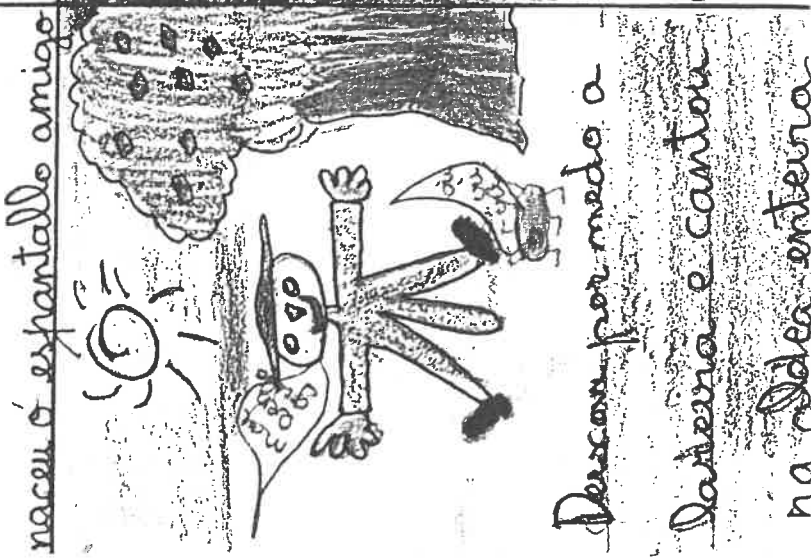

Descon por medo a

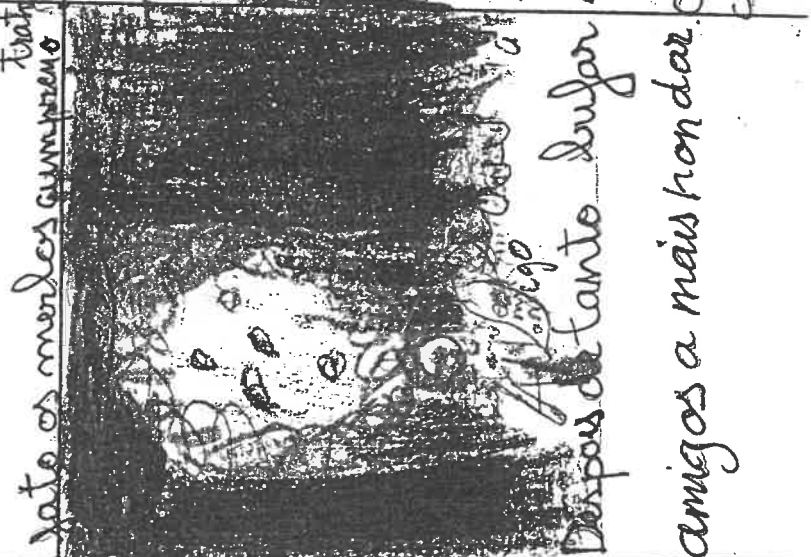

Despois de tanto bulgar

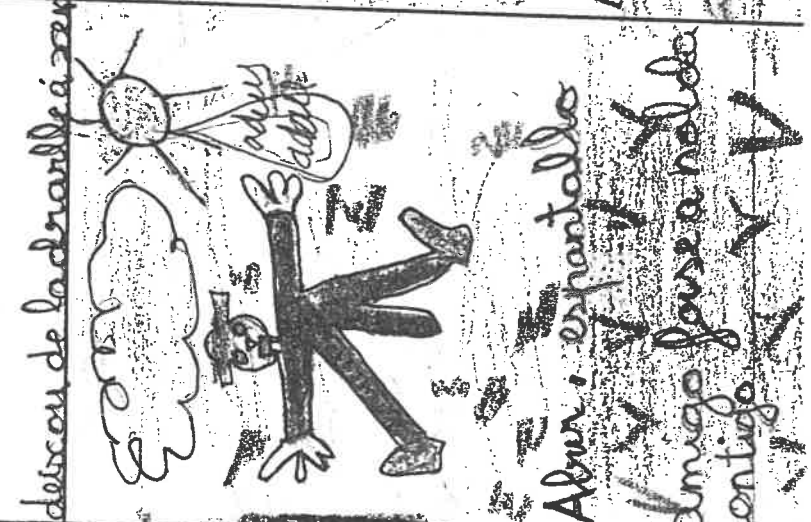

Abur: espantallo

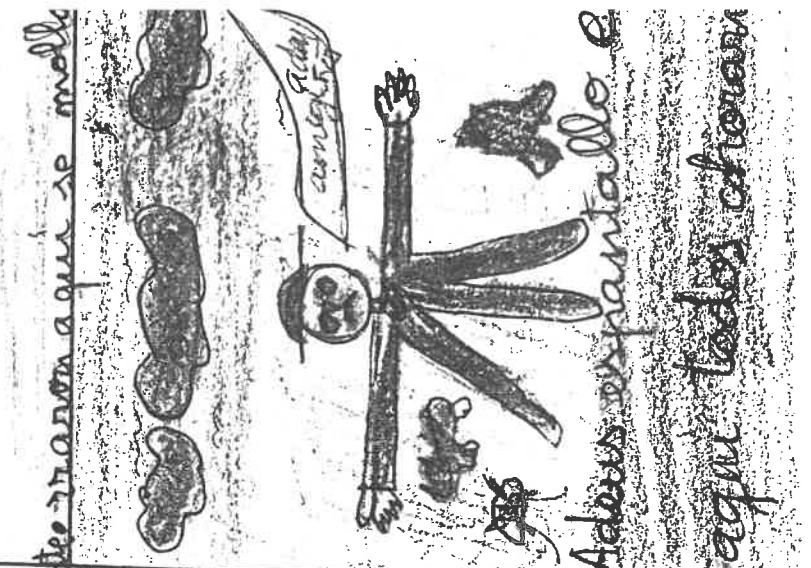

Adous espantallo e

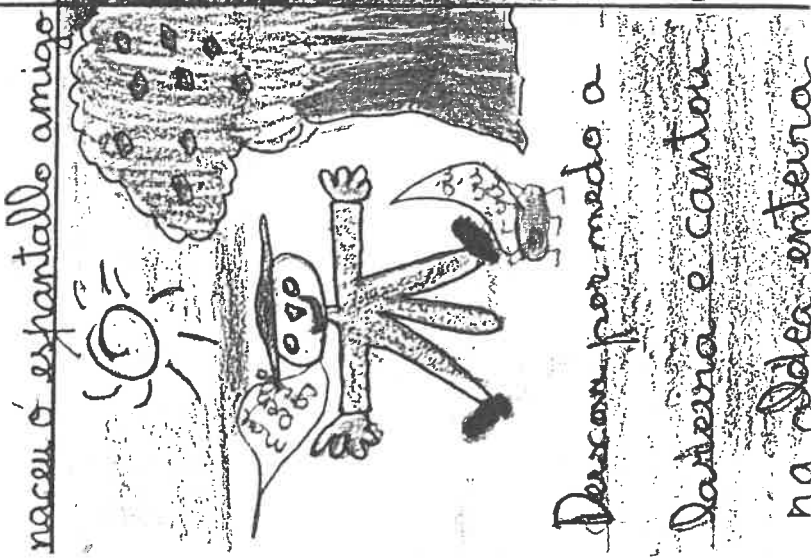

Danceira e cantora

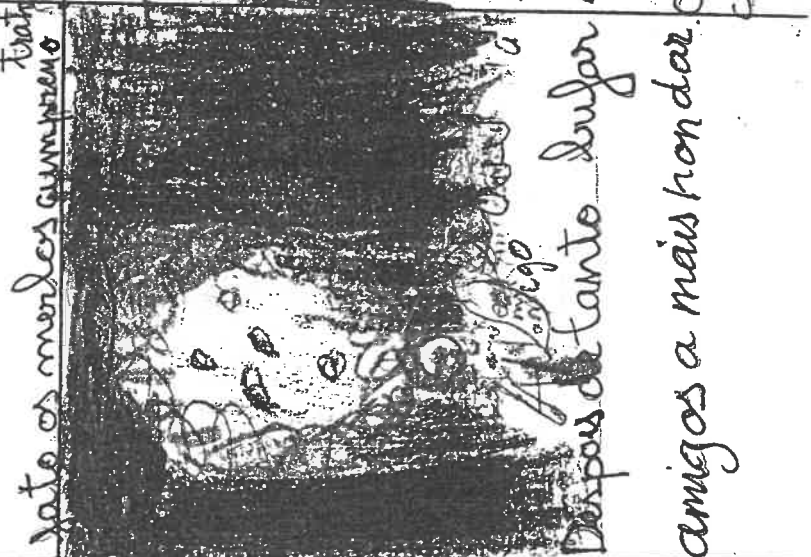

na idea enteira

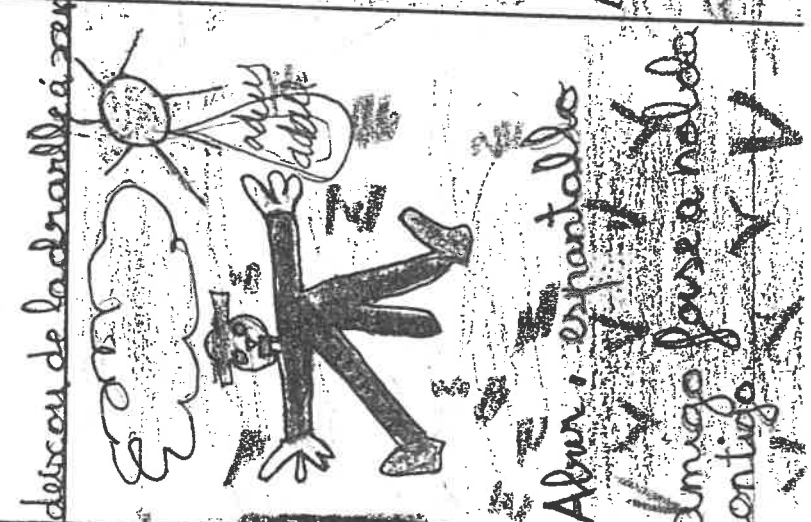

Amigo fouse a holda

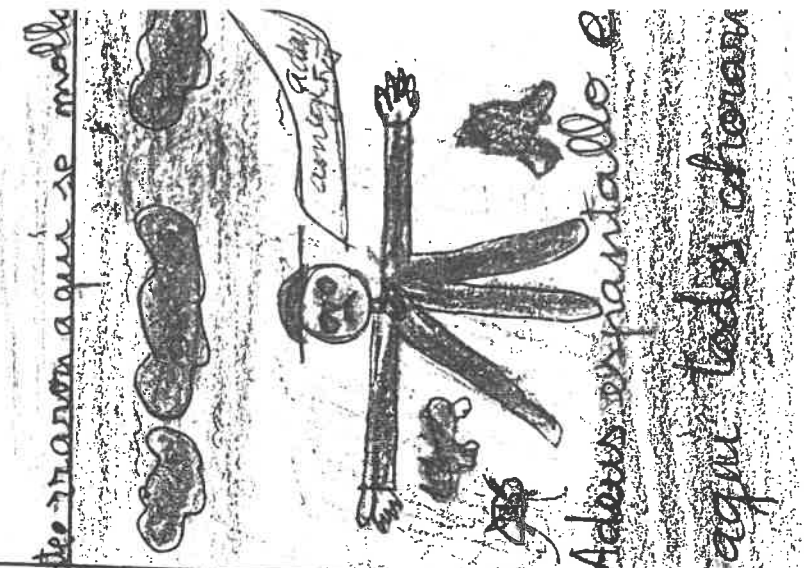

centigo

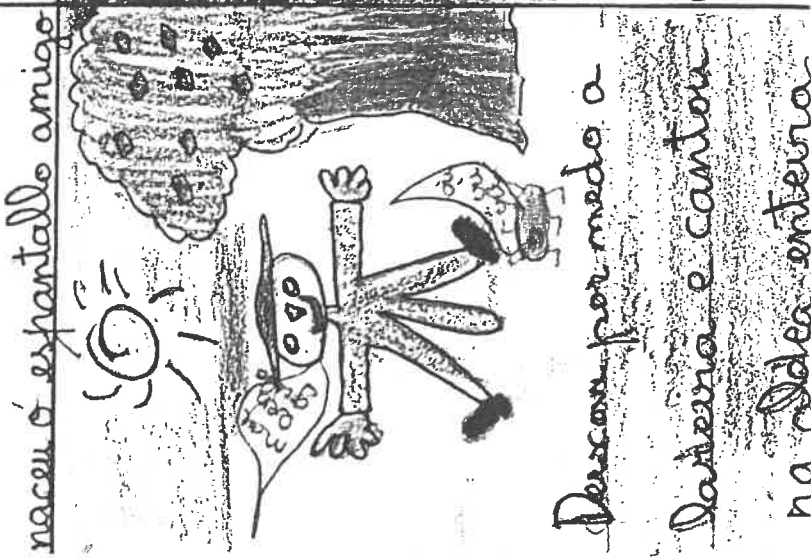

Descon por medo a

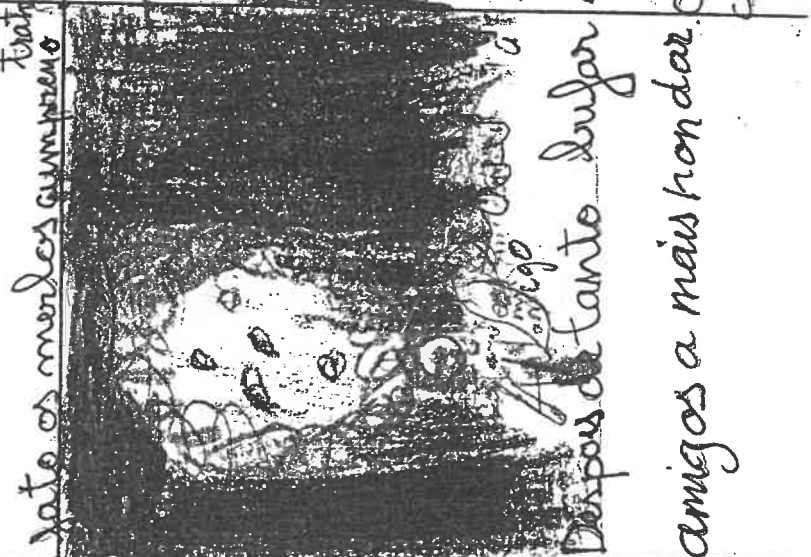

Despois de tanto bulgar

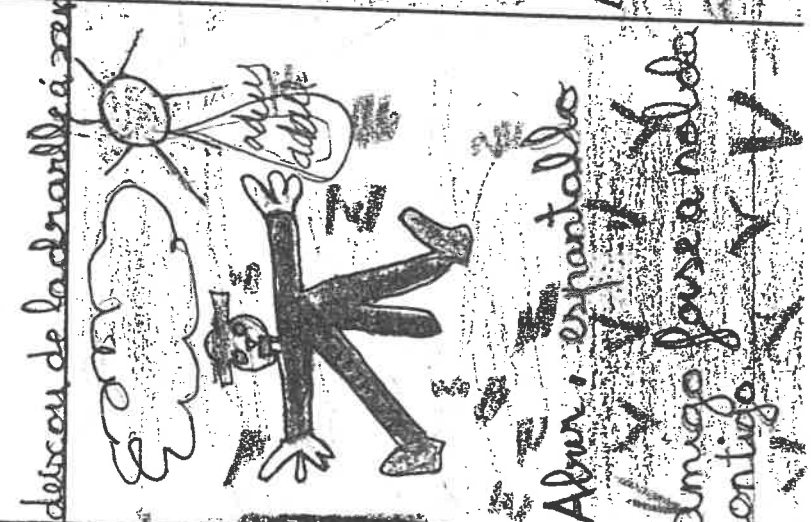

Abur: espantallo

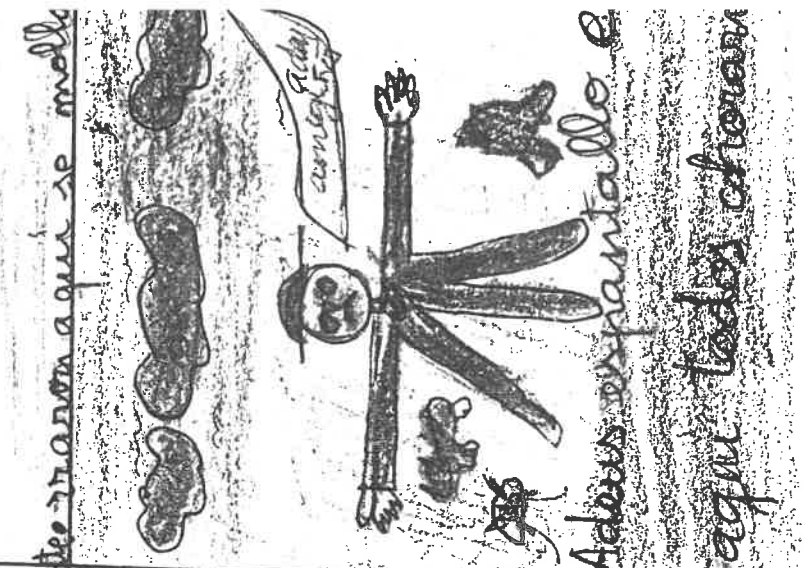

Adous espantallo e

O MONSTRO DO LAGO NESS

CAMHA NENA

EDGAR-408

O dia seguinte apareceu unha nena e di:



A nena salvou o monstro do lago Ness da morte.



O monstro do lago Ness e a nena foron xogar á lago.

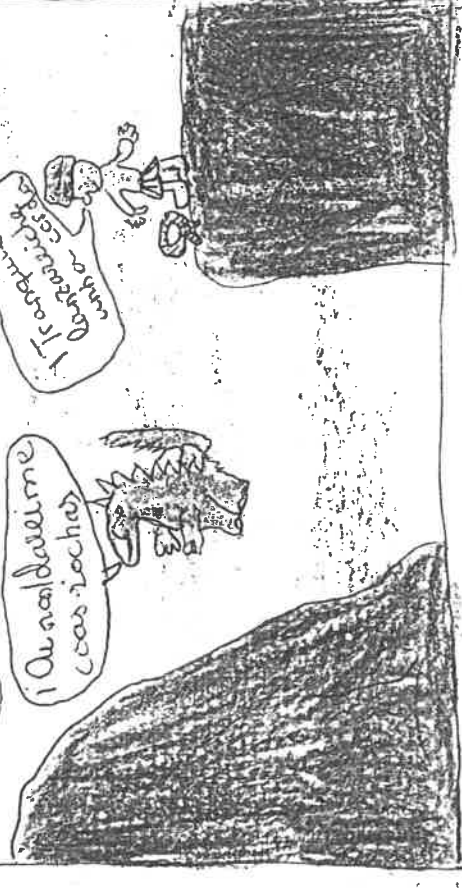

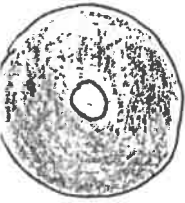

PAXARRO COXO



MARTA - 4º B

De pronto... Cai para o chão



Uma noite

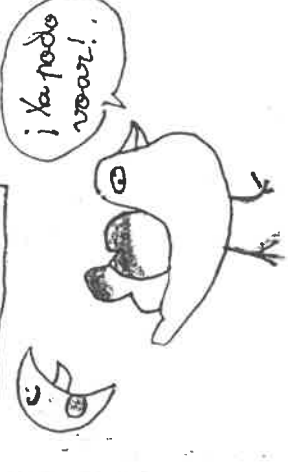

Uma pessoa caiu e curou-se.

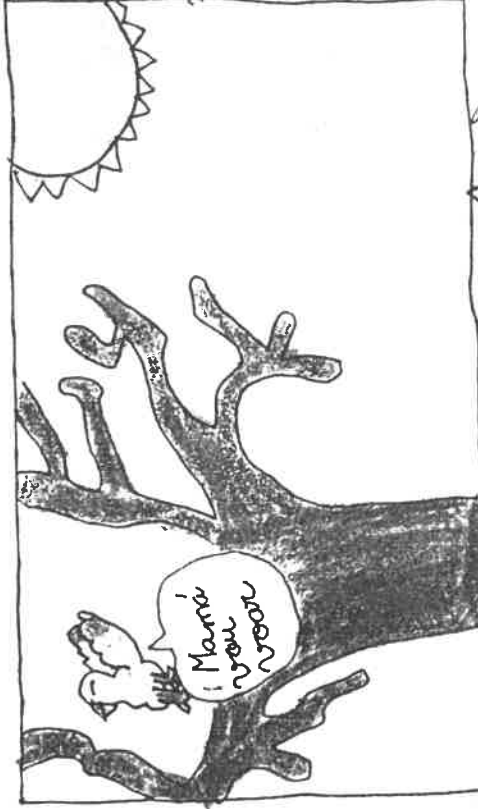

ALBES E TEBES

TATIANA - 4º B

4ª parte

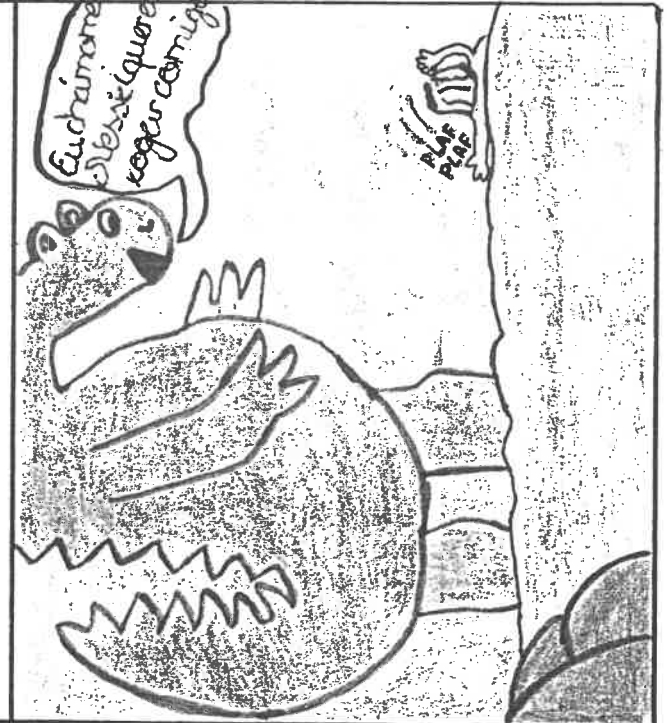
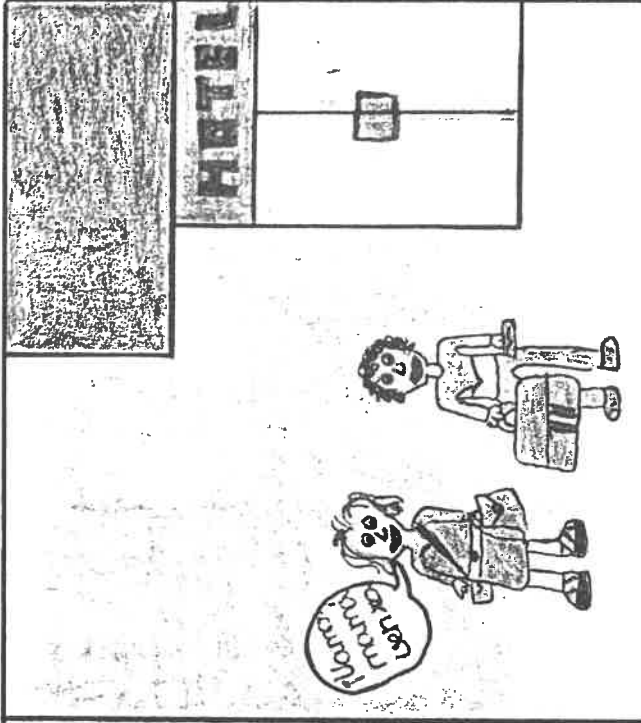
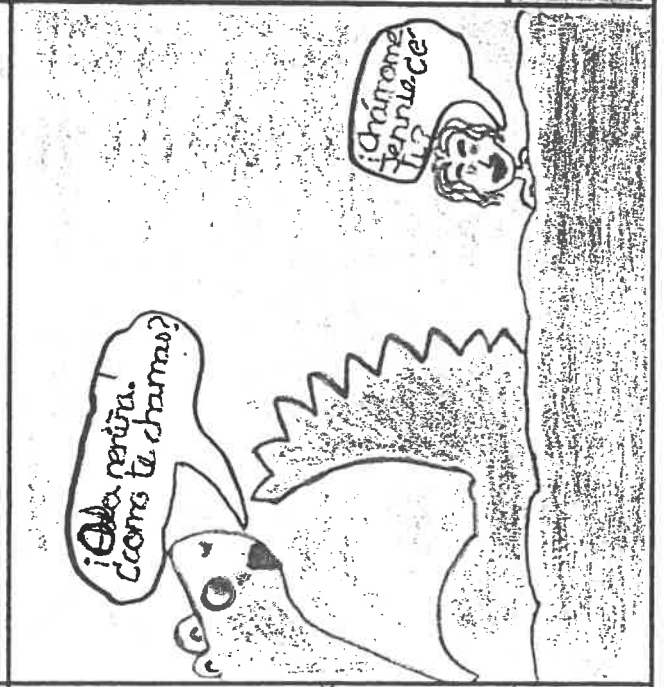
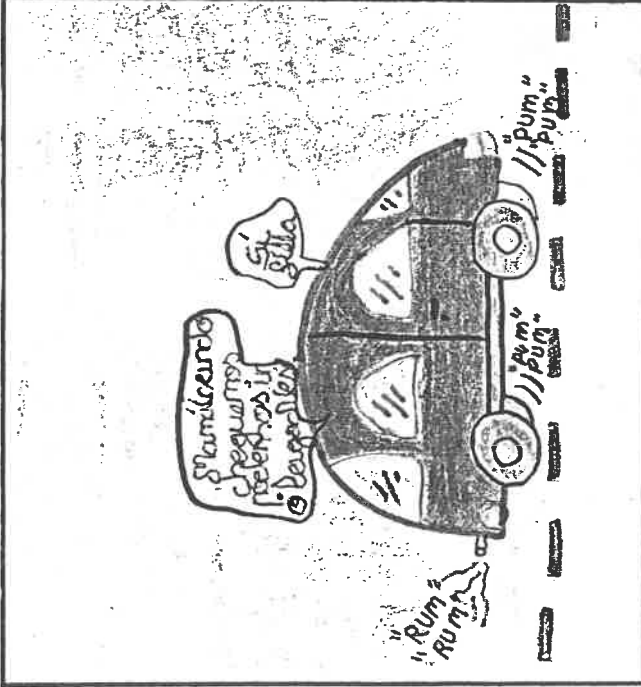
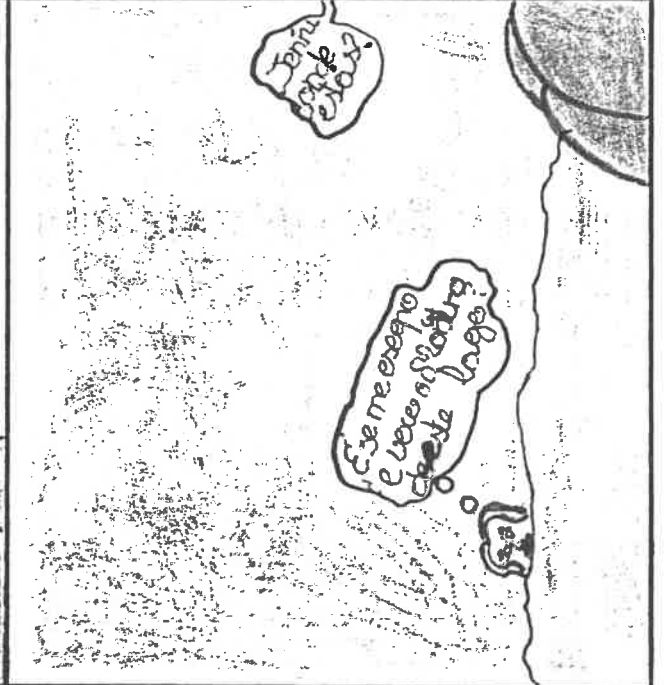

2ª parte

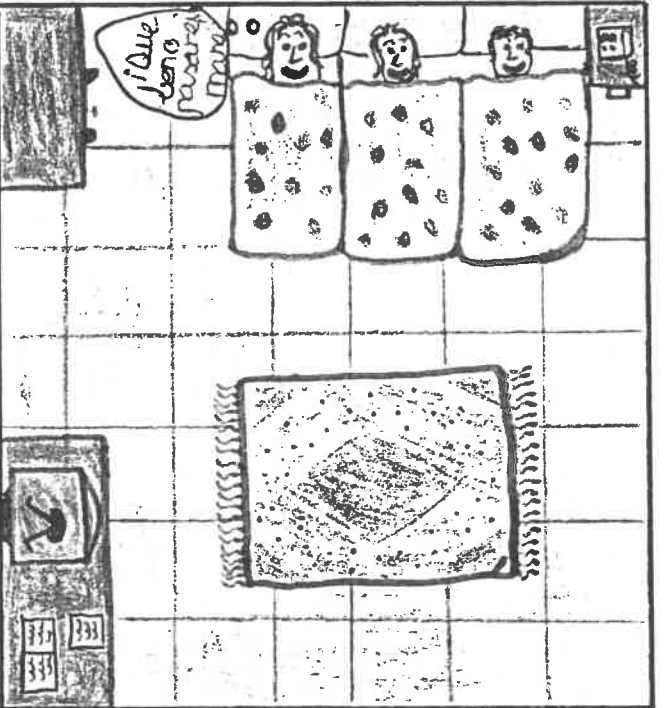
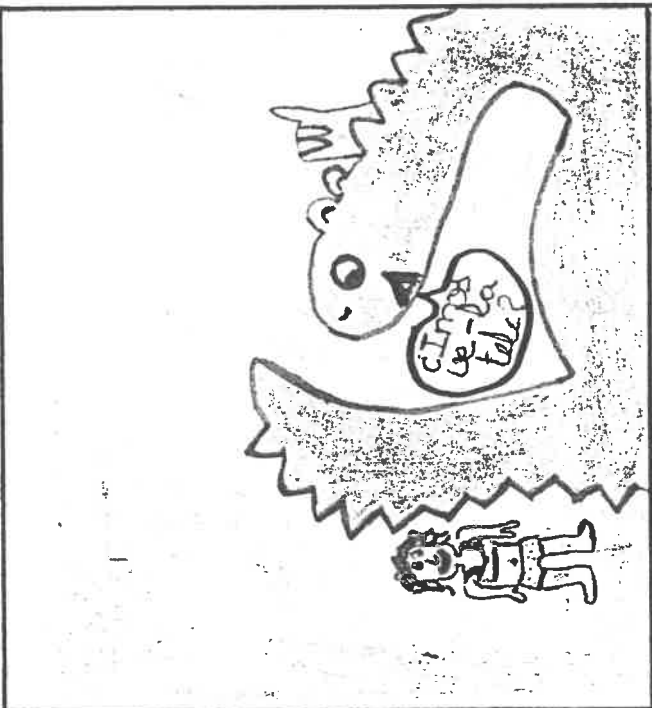
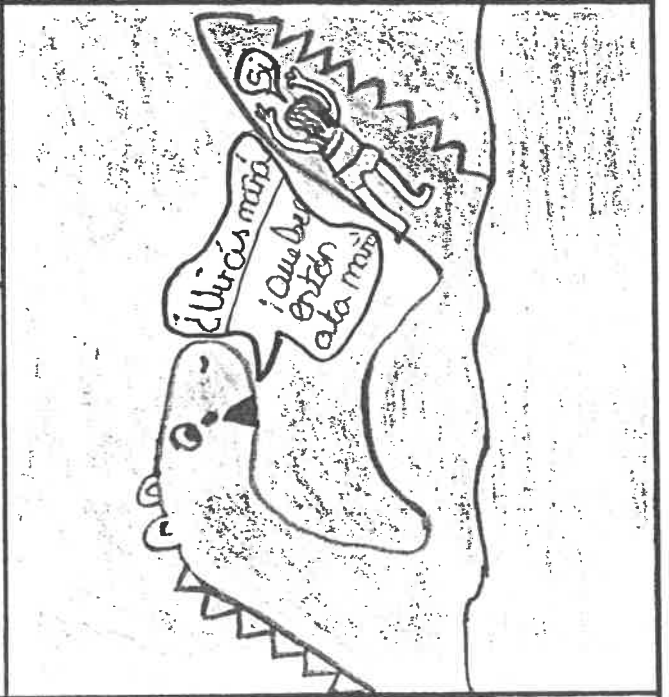
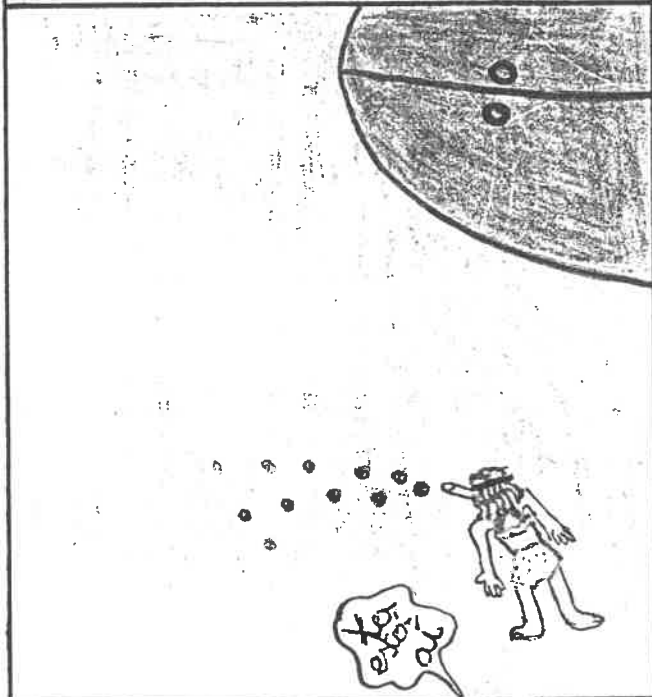
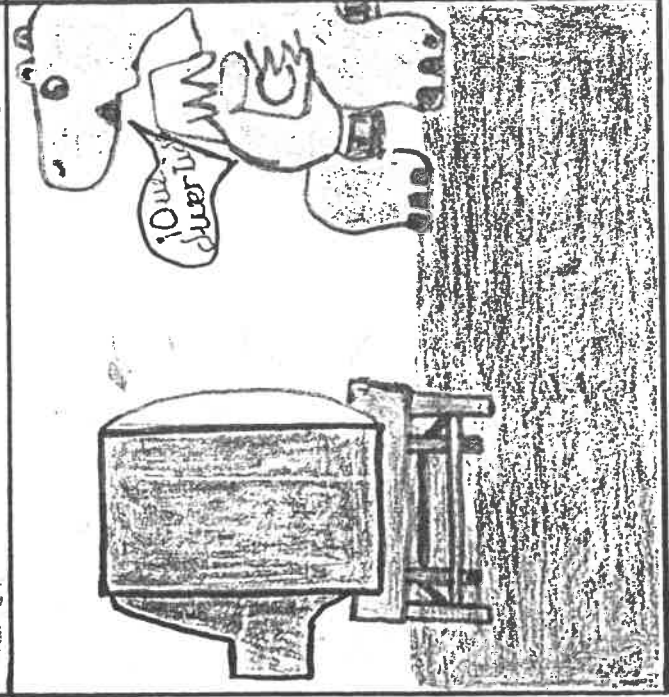
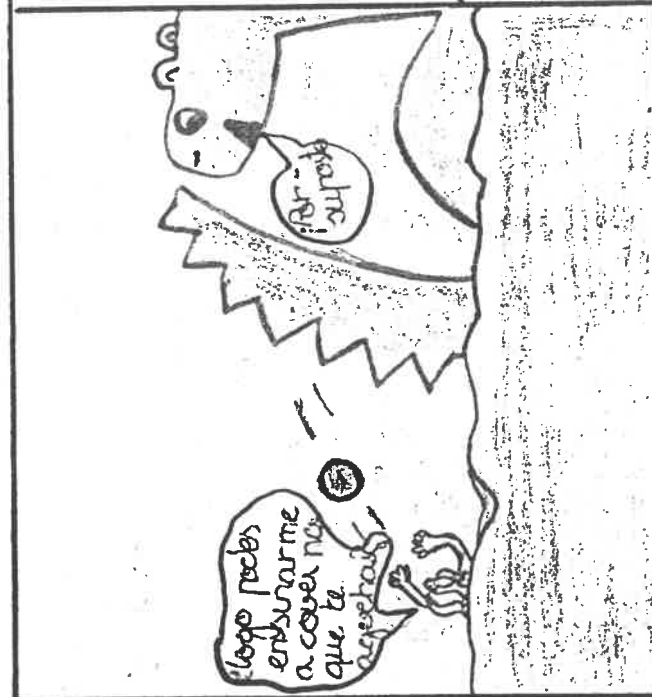

POBLES

1^a parte



O Bolo

Logo o bolo que fui
melhorado o tempo
das amas.

! O bolo usamos
! por duas.

! Bolo das
! curmão.

O bolo que
! não é mais como
! o bolo.

Um bolo de bolo redondo.

Os animais decidiram reduzir
o bolo e queriam para
! reduzir.

! O bolo
! das amas,
! por duas.

! O bolo curmão tomou o
! mesmo.

O bolo seguinte é seu curmão,
! por duas o mesmo.

... DA CADEIA LUA.

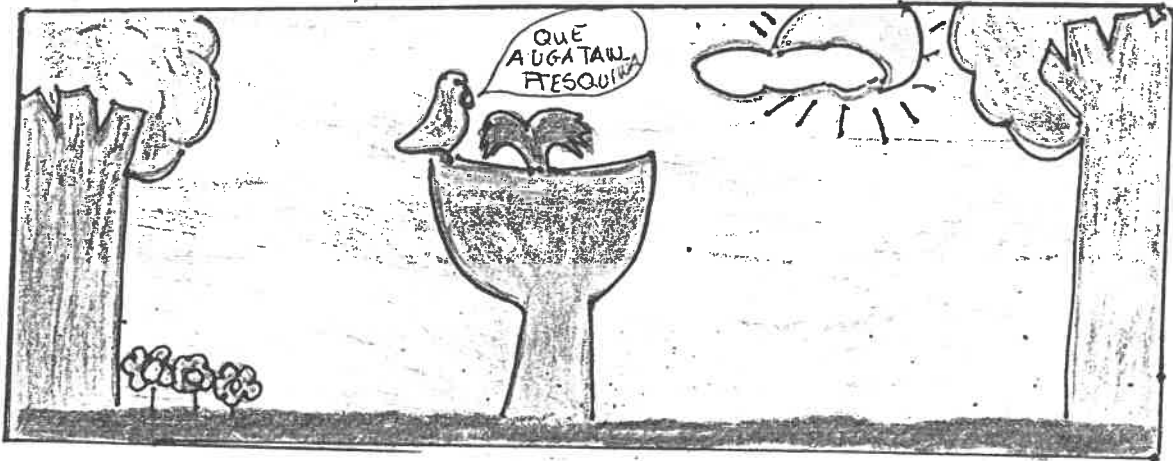

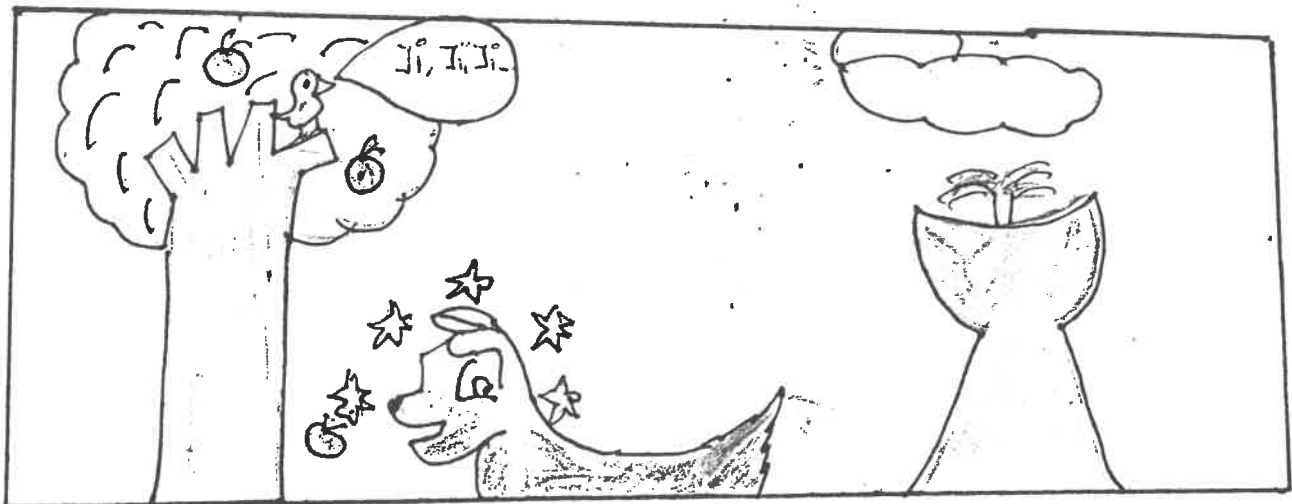
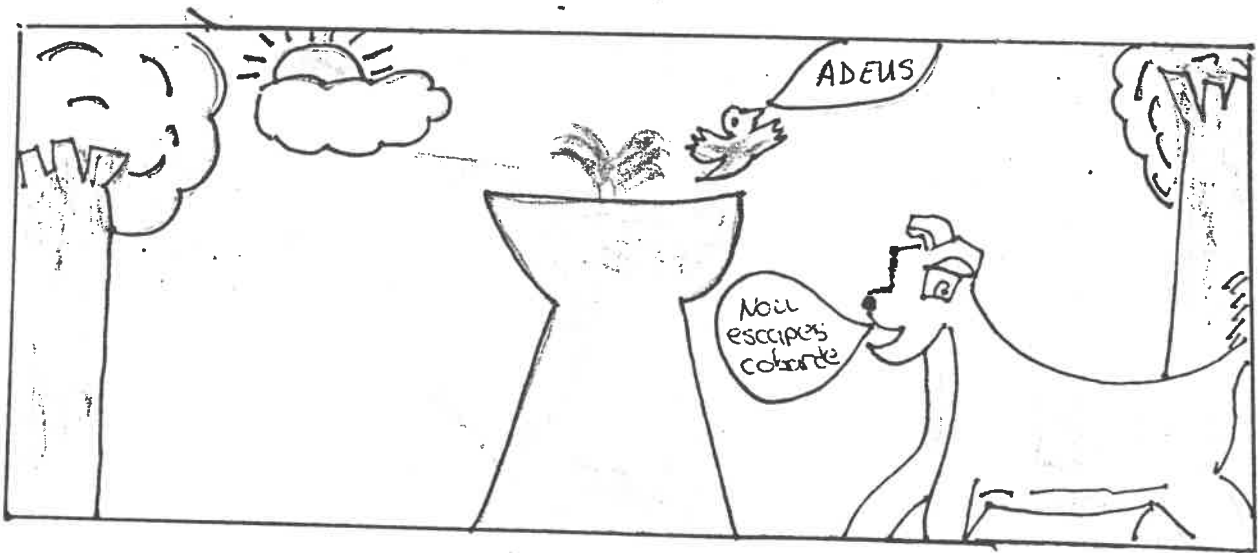

Fin

QUEXARÁ

Dani...ia pola bosque e...

Má...is tarde...

Pois que...

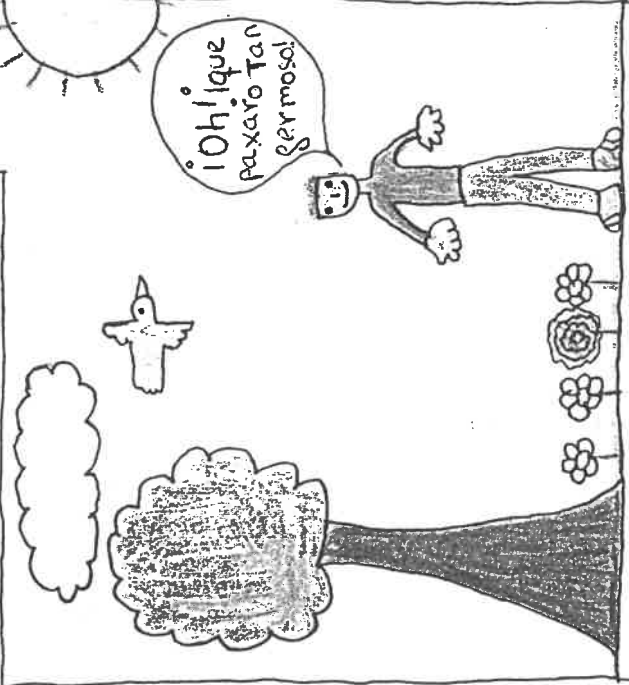

¡Oh! que paxaro tan guamosal!

¡Mamá! ¡Vin un paxaro e gustoume moito!

¿E que me queres dicir con isto?

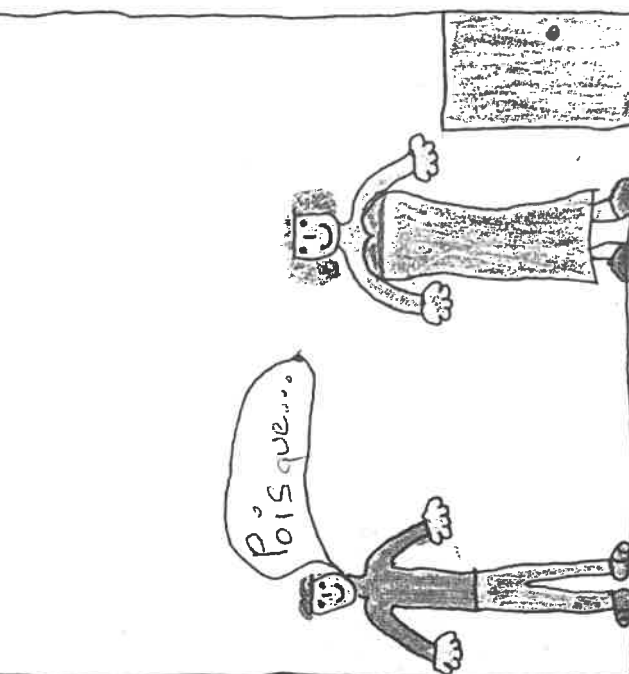

Pois que...

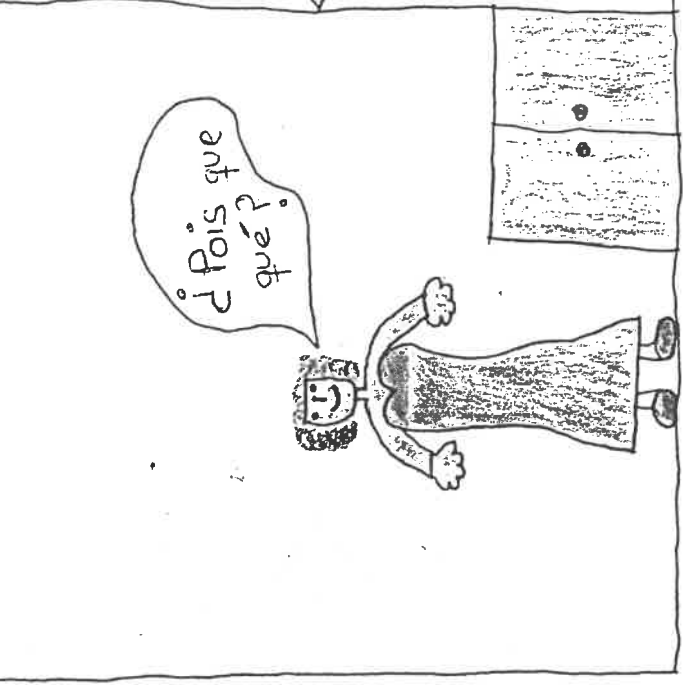

¿Pois que qué?

Se o podía traer para casa...



¡Iso nunca! ¿non ves que el está acostumbrado a vivir no bosque e non sobreviviríanunha casa?

Fim

AMIZADE

O dia anterior a excursão



O dia da excursão

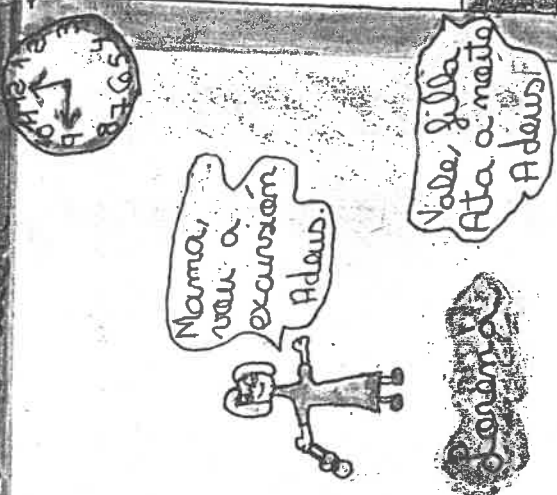

Xo chegaram a Carubeda.

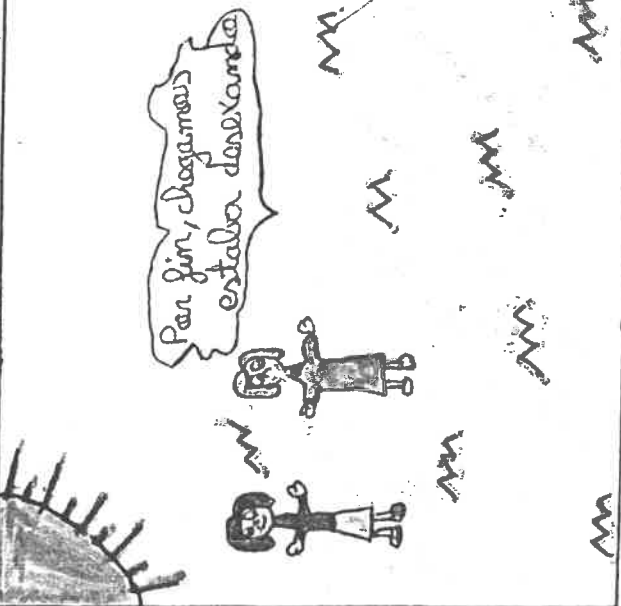

Uma ideia

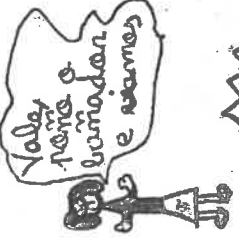
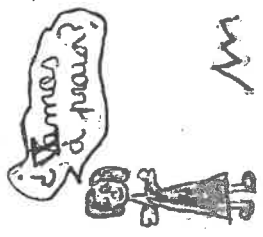

Xo na praia de Carubeda

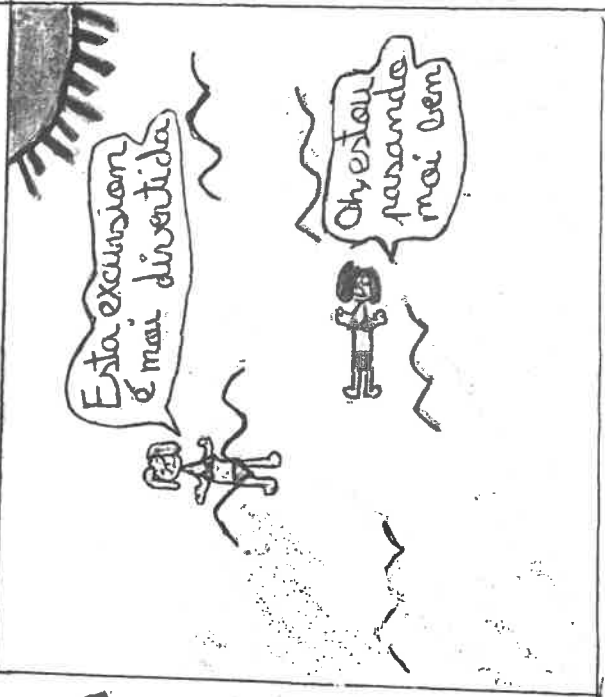

Na volta a...

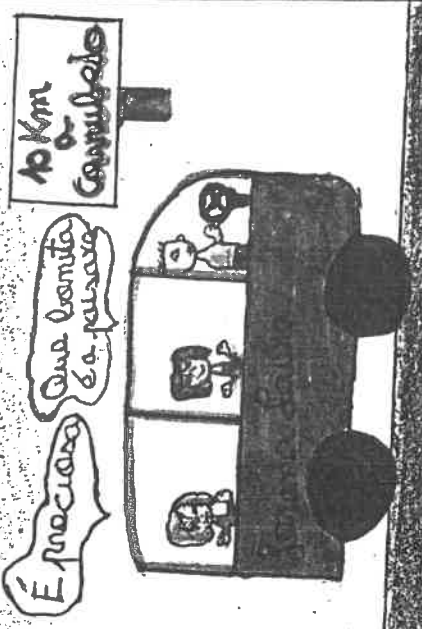

O CAMINO DE SANTIAGO

1
 ★ ★ ★ ★ ★
 Non corei
 A Coruña ↑
 Eu, tamén
 non eres
 a única

2
 ★ ★ ★ ★ ★
 Feu
 Non vos que
 dedos
 outros

3
 ★ ★ ★ ★ ★
 Non vos que
 dedos
 outros

4
 ★ ★ ★ ★ ★
 Non vos que
 dedos
 outros

5
 Dentro
 Dumpe
 Boos
 Nites

6
 Descousan e comen
 Se, cumcan.
 Oh, deus

7
 Siquen o seu cambio e atopan.

8
 Siquen o seu cambio e atopan.

9
 Sesen despois de chamar
 a garda civil.
 CASA

10
 Sesen e rematein
 Non está
 chesmos

11
 en Santiago
 Nós remontamos
 con
 máis de vos, en que
 aprendelas?

12
 en Santiago
 Nós remontamos
 con
 máis de vos, en que
 aprendelas?

Belén Varela. Noire 6ºB

!!! dexada e delphin!!!

Yanesa Sande 6ºB

GOLF, nada de nada

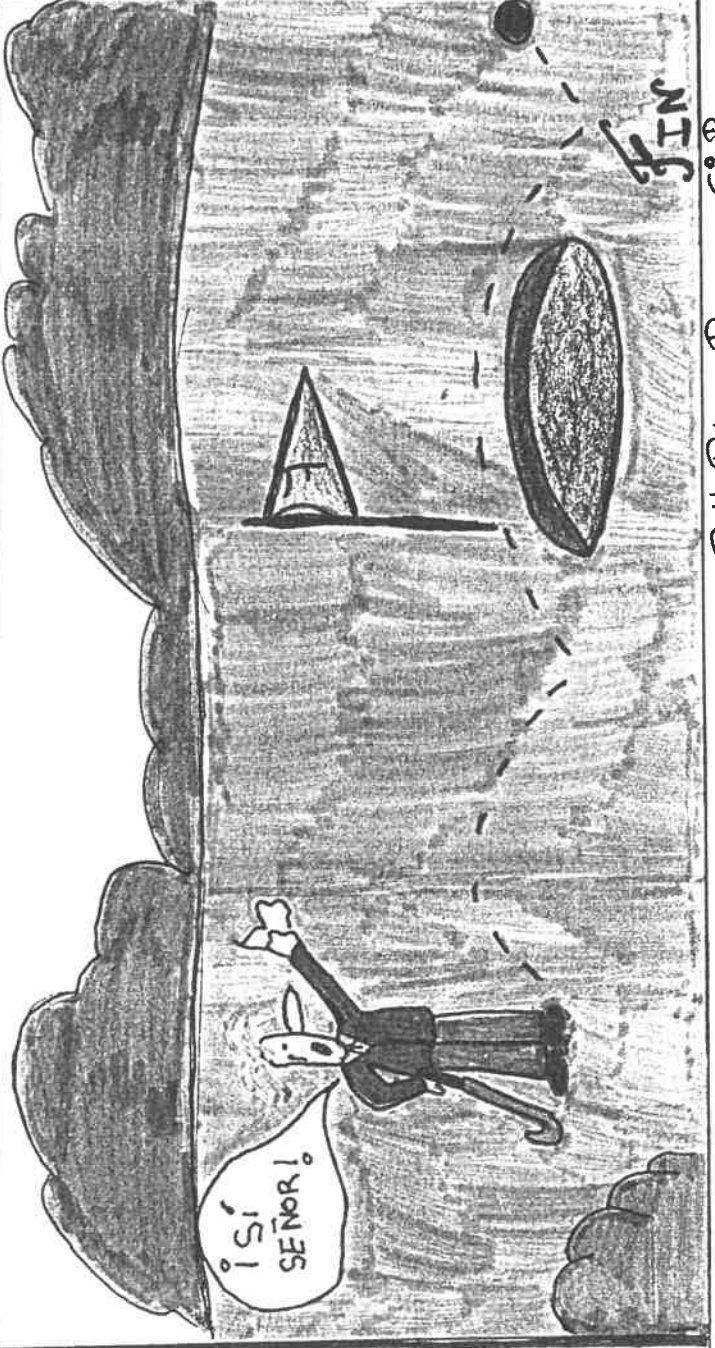
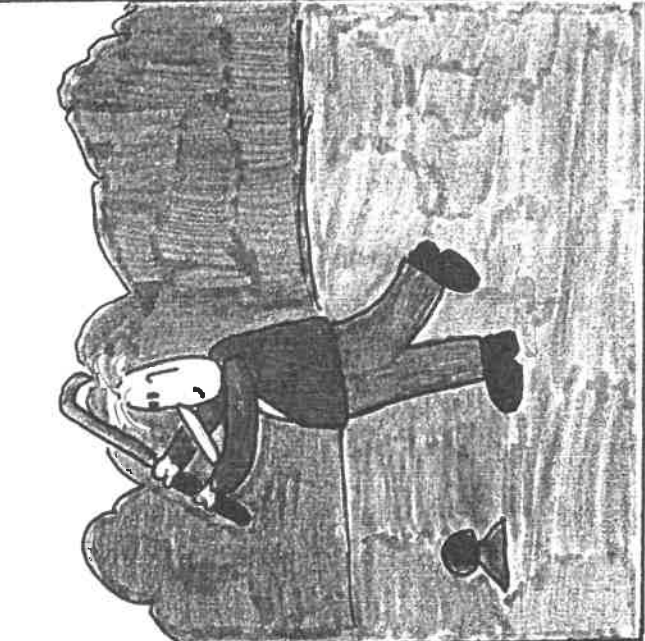
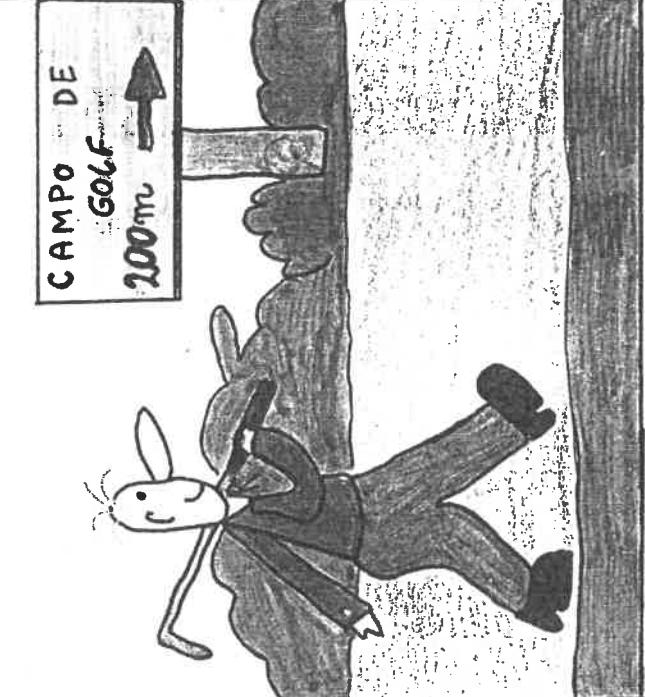
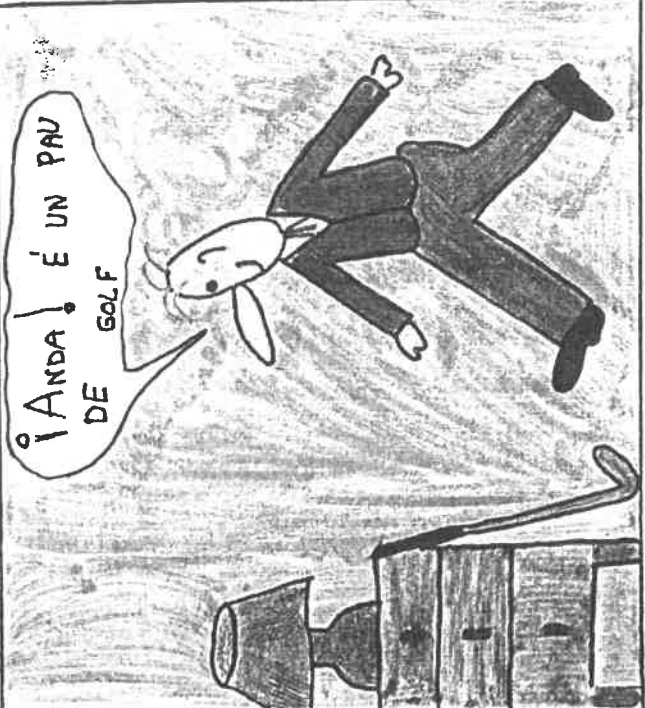

PITAGORAS

Quero que me deixen

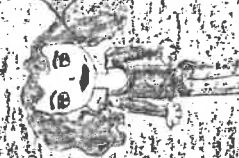

Porque como quere sair

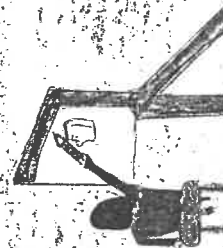

Doas horas despois

Ven despois de tres dias

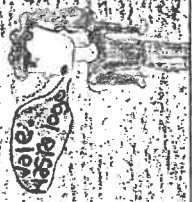

Vale, hasta logo

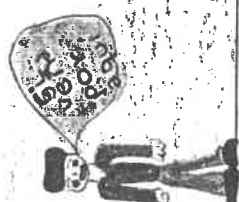

Un dia despois...

Quisessame cinco e

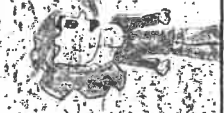

San cinco e cinco 10000 porces



Xa na praia...

Vos piteiros que así me inspirou mellor

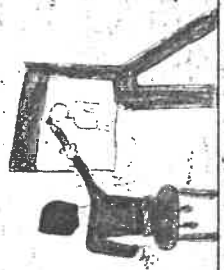

Cinco horas despois

traballo

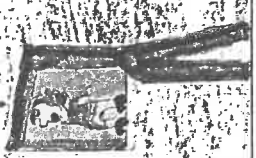

Pasaron os tres dias...

Empreza sempre en crecer



Quedan unha dita de arte



Crístanse moito



UNITS VACACIONES

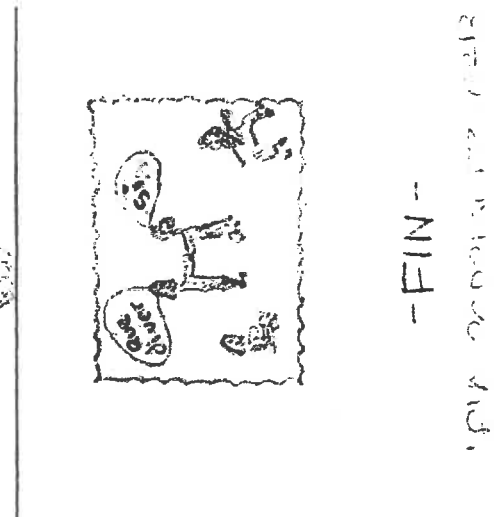
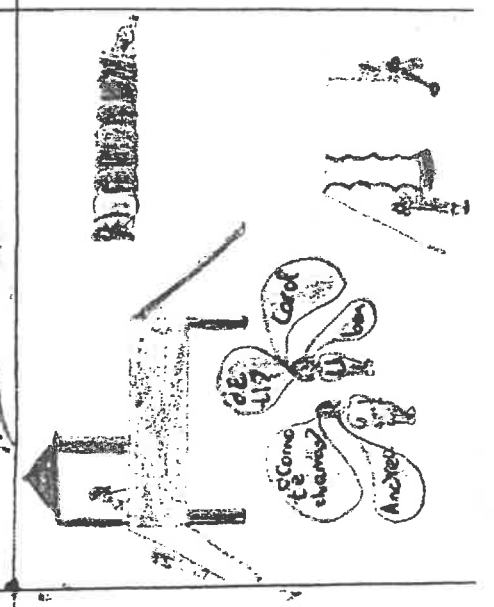
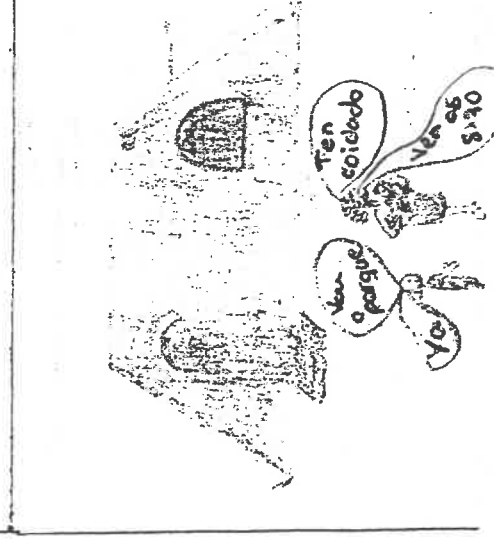
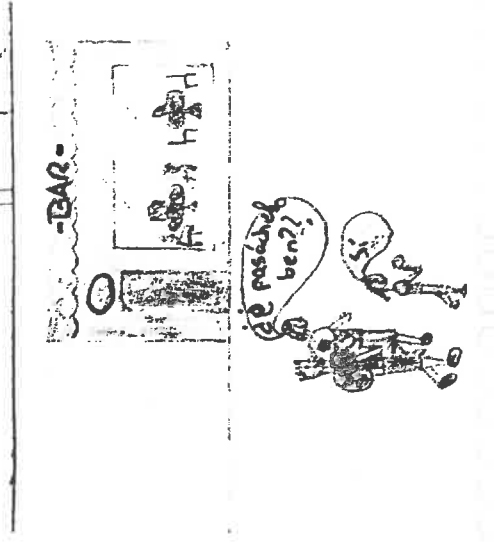
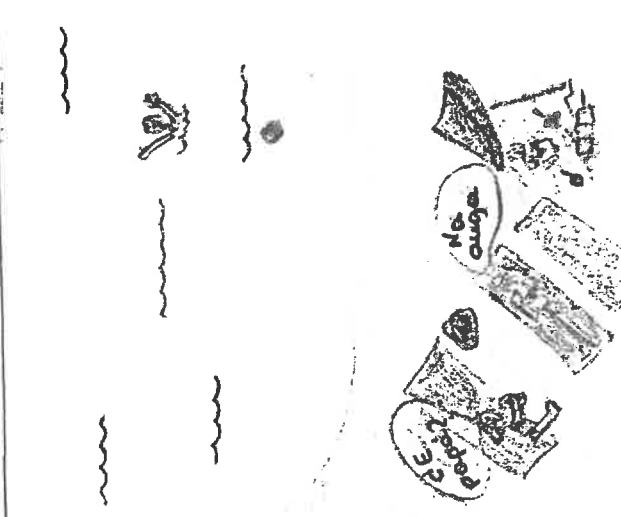
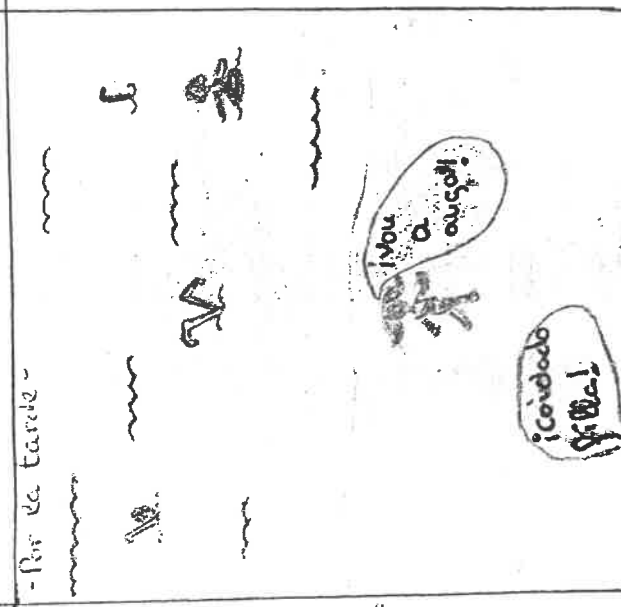
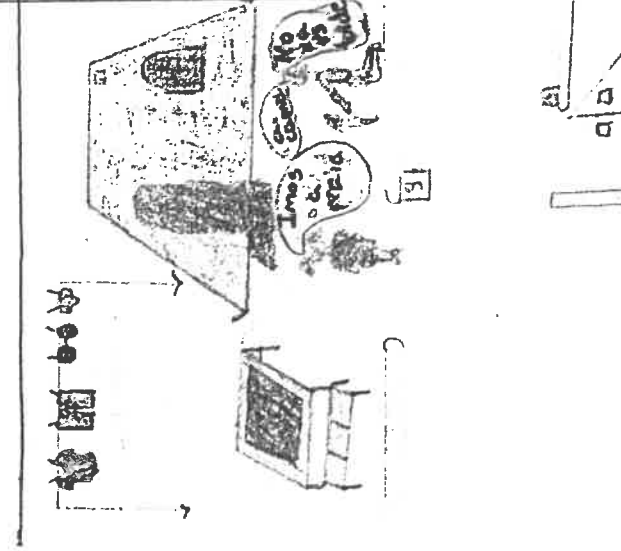
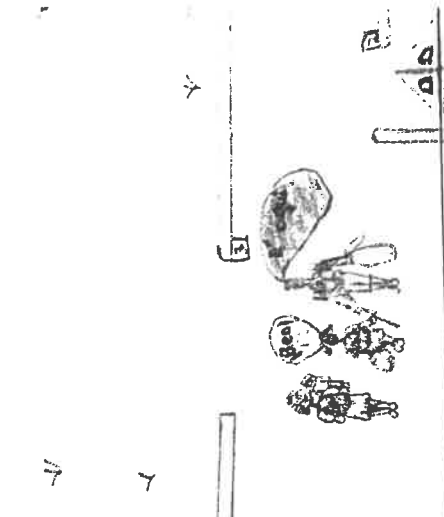
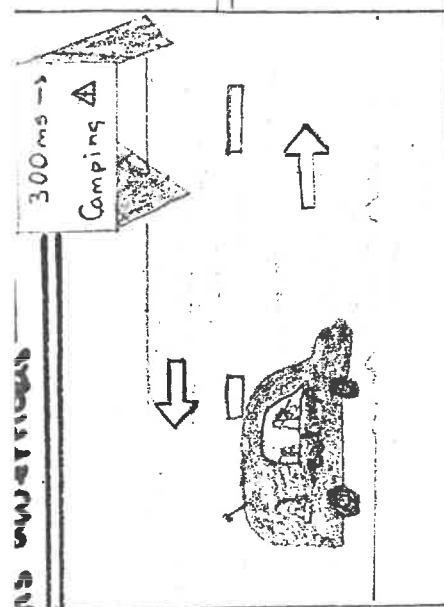
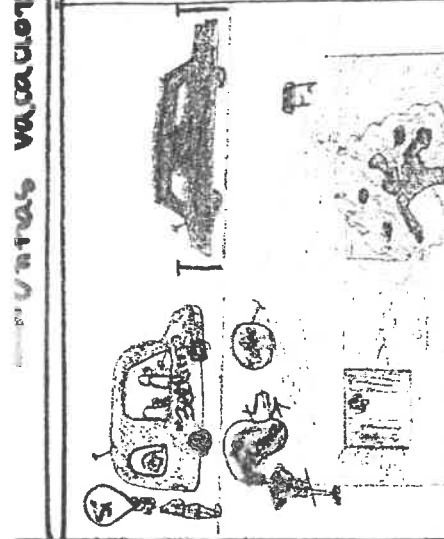

-FIN-

FIN



Non recorda quietem
que dar unha conferencia
no centro gatuno.

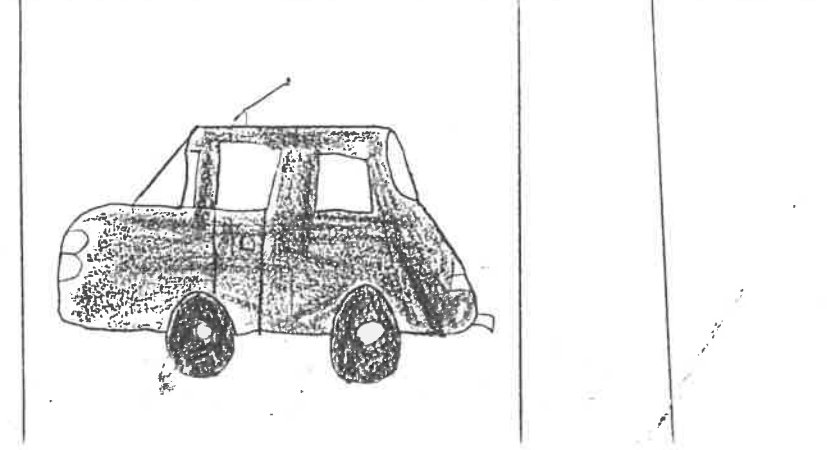
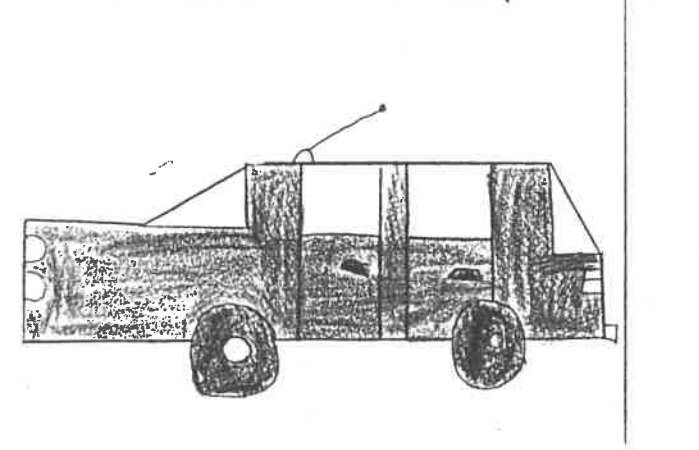
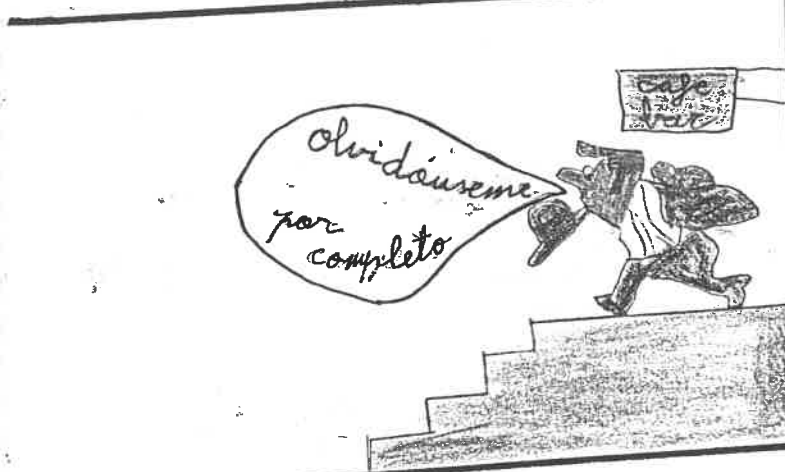

FANTASIA

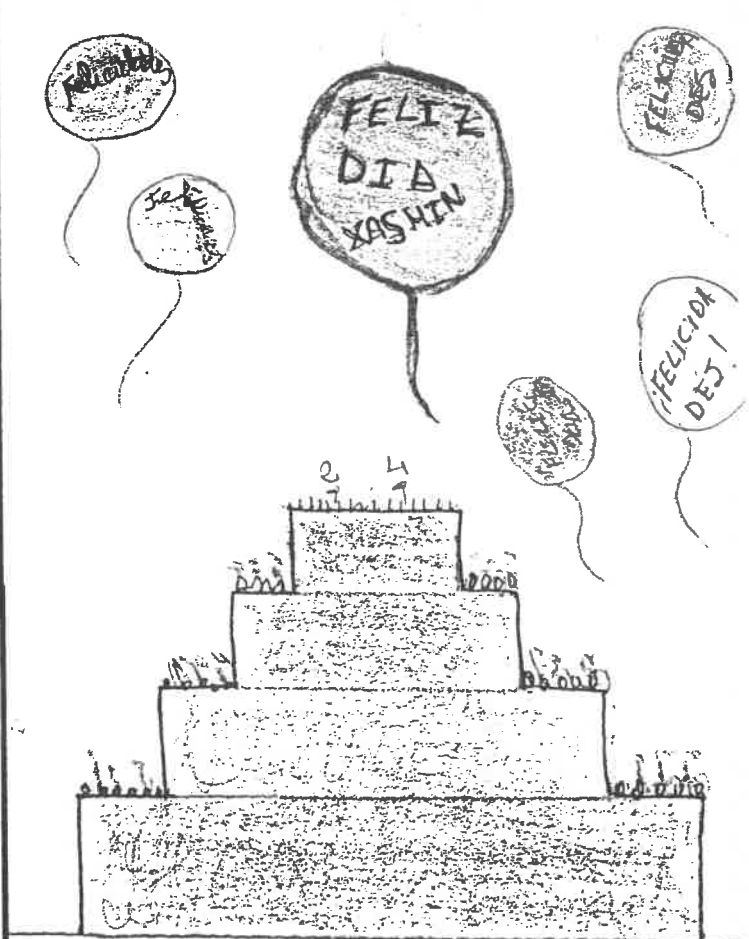

CARME E HELENA

O REGALO





FIN

Alejandro



Natalia
 Martínez
 Conca

Natalia Martínez Conca A N° 25

¡Ai, os Autores, que TRÁBALLE O SEU!

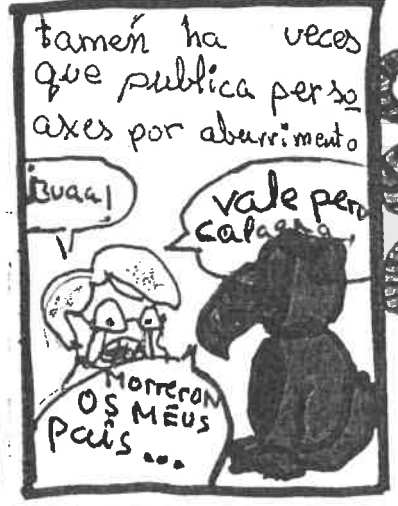

FIN

MUNDIAL DE

KOREA E JAPON



VARIOS PAISES
O PRESENTARAN
COMA UN CAMBIO
AUNQUE SO GANAR
UN...

TV3

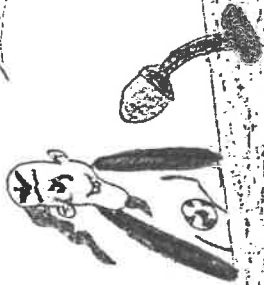

PASARON OS DIAS... ESTAMOS NA SERIE
MAL DESDE APASIONAMOS TUQUE SE LOGRARE
LASIEGA... ESPANA, INGLATERRA ARGENTINA E
BRASIL... KOREA... JAPON...
ES PAGA INGLATERRA... ARGENTINA... BRASIL

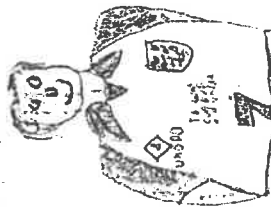

ESTAMOS AQUÍ, DEMOS
O XAPON PARA PIR,
SENCIAL ESTE PABLO
NAME MUNDIAL...

TV3

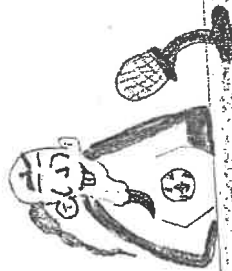

SO ESTADIO ADRIANO...
WWW...WWW...WWW...

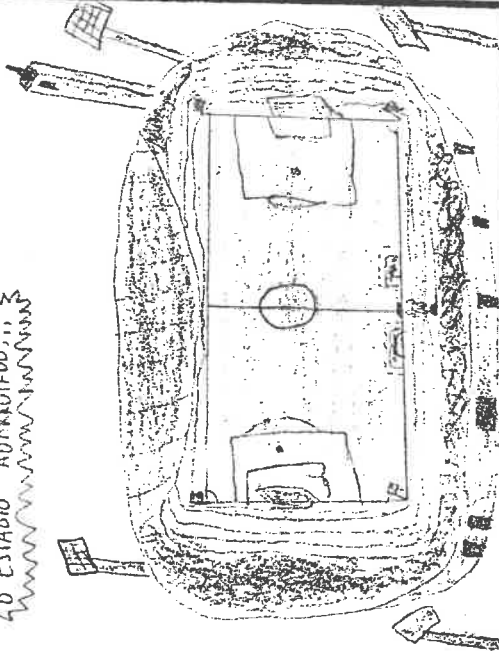

POR FIN ESTAMOS NA FINAL ENTRE INGLATERRA
E BRASIL...

TV3

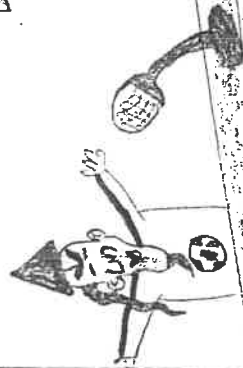

DOS PAISES OUTRO HONDRIL
WWW...WWW...WWW...



AS DUAS SELECCIONS ANTERIORMAS FARM
O PARTIDO DA PRESENTACION...
WWW...WWW...WWW...



TV3

RONALDO...

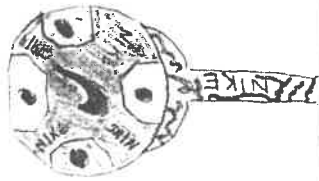
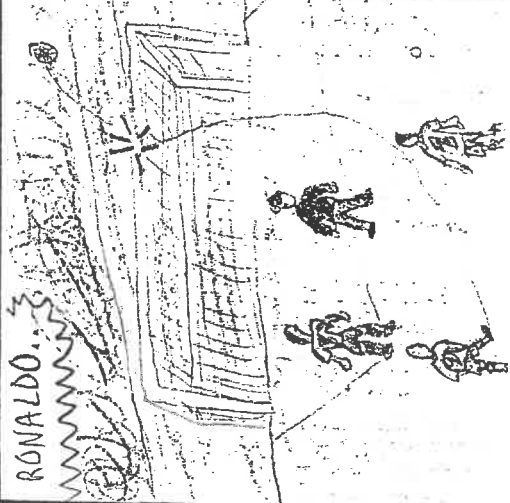

AUNQUE ESTE PARTIDO LO NESTI
TADO DE XAPON 5 - KOREA 3
WWW...WWW...WWW...



!!!GOOOOL!!!
Inglaterra campeona
WWW...WWW...WWW...

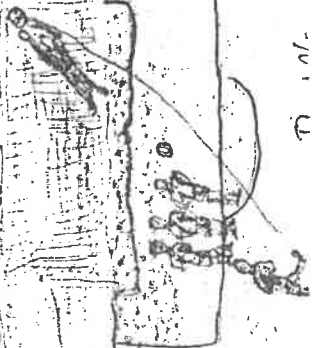

DUBIAS

Carme e Helena teñen que comprar un regalo ó seu amigo Róber entra nunha tenda deportiva.



C = Ése lle mercamos unha raqueta.

H = Non me parece unha boa idea.

C = ¿Entón?

H = Miramos nesta tenda.

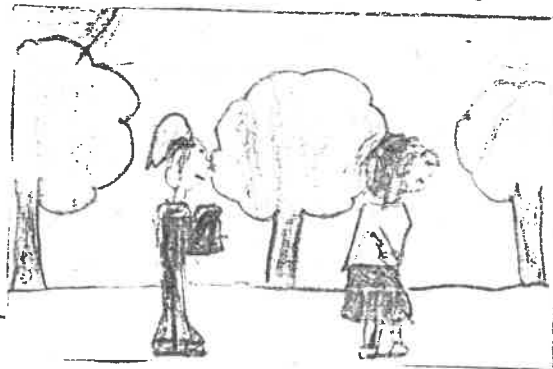

Dez minutos despois...

H = Moitas grazas polo seu consello! Ata logo!

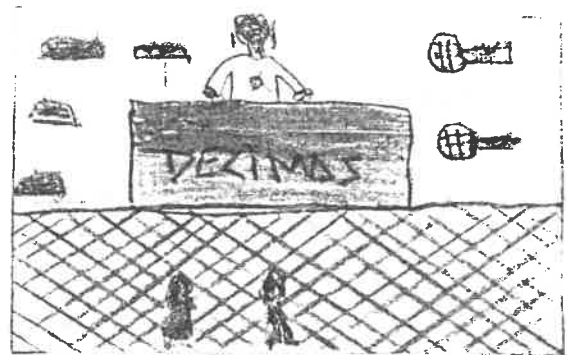

D = ¿Que desexas?

C = Queríamos mirarlle un regalo para un amigo.

H = ¿Que nos aconsellas?

D = Teñemos estas tenues, estas mochilas...

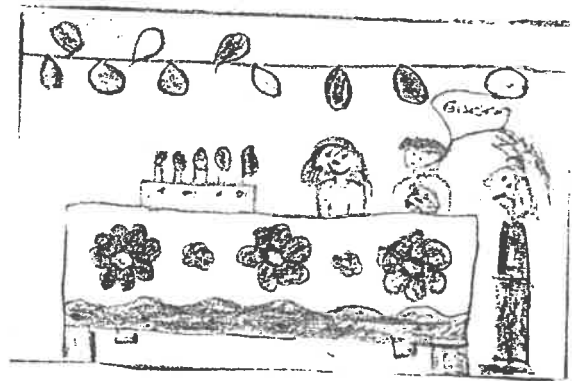

C = Toma Róber este e o noso regalo! ¡Felicitades!

H = ¡Feliz cumpleaños!

R = ¡Oh! Un balón ¡grazas!

AUTORES : Fátima F.B - Elisa F.M - Caterina C.V.

F E N

Un dia máis Brais e Xoro de com 1º E.S.O
proas ma noi

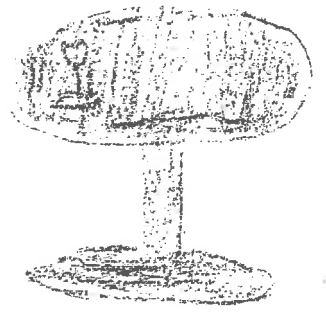

O día seguinte



E o efecto das pastillas estan na loís qe...



Entón cambáron os mobles



Despois de colocar os mobles
fórannelle os efectos

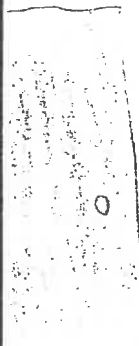
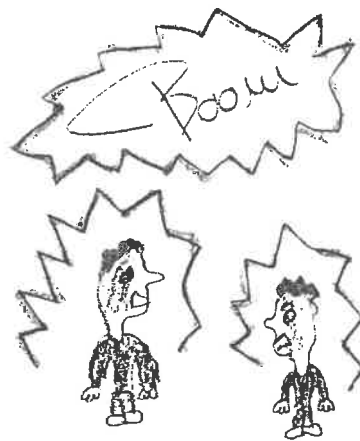
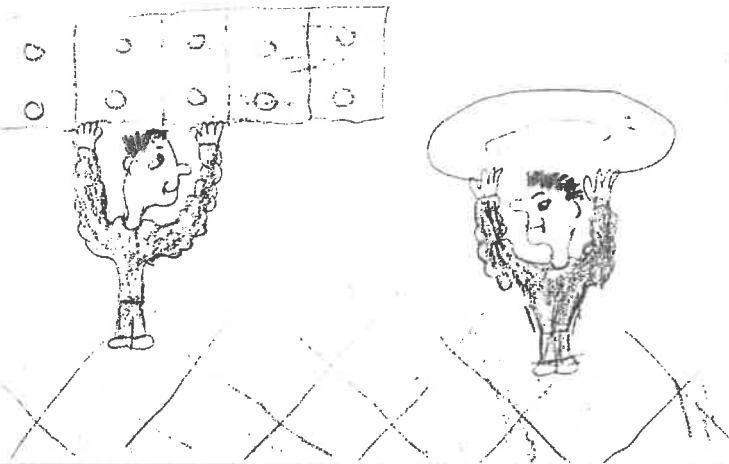

~~Frío~~ CF

Nº 8 1º A

RAA

¡EH! ¿QUE PASA ALÍ?
VOU PARLIE UN VISTAZO

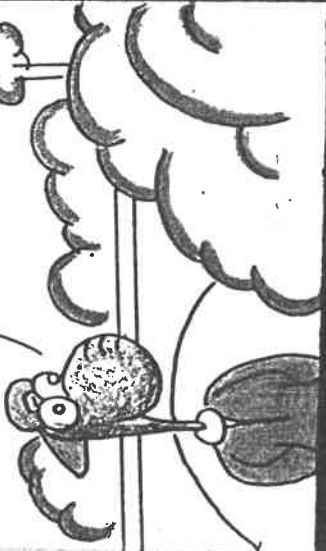

¿DUNDE SE MUEVE
RÍA A XENTE?

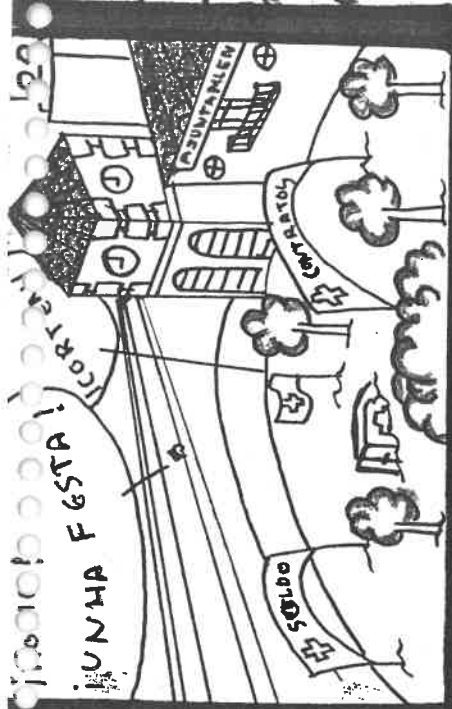

¡UNHA FESTA!
¡CORTA!

PROTESTA

¡MEU DEUS!
¡UN
INCENDIO!

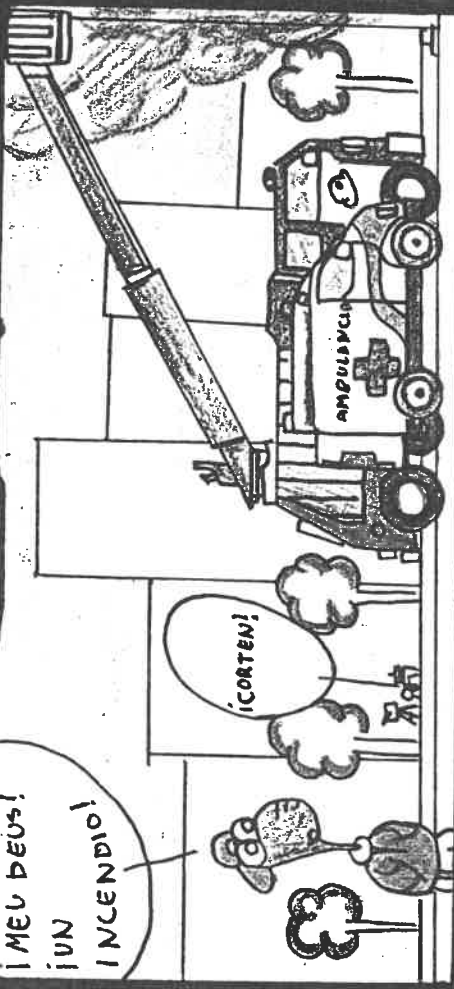

¡CORTEN!

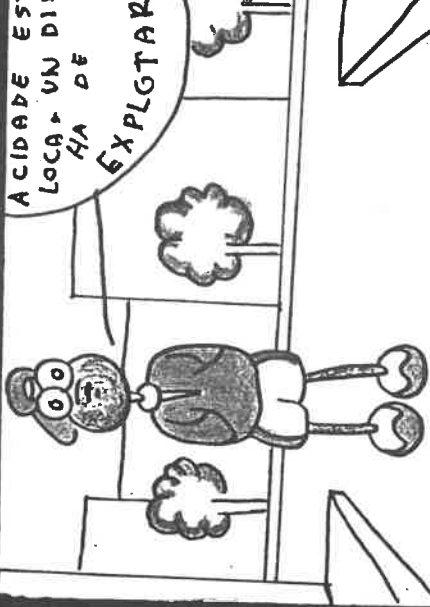

ACIDADE ES
LOCA + UN DI
HA DE
EXPLGTAR



¡CORTEN!

¡PERO PUE DIS RAPI
A CIDA DE, ESTA NO CENTRO
DUNHA PELÍCULA QUE ESTAN

FACEBDO UNHOS
AMERICANGS EN
ESPAÑA

¡EH! MARTIN
LIUBO
UNHA
EXPLOSIÓN
NA CIDA DE

¡N000000!
00000000!

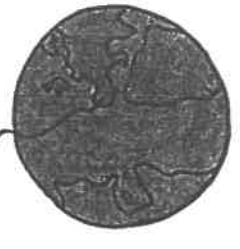

VIA

MÁTICAS

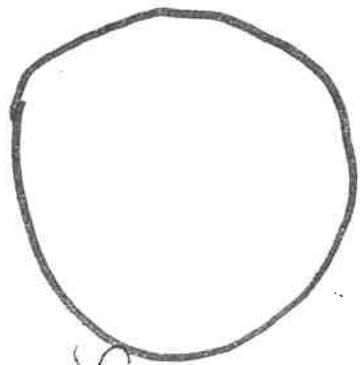

O que puxo que 2x2 era 15! e que 5+2 era 10'83 e que...

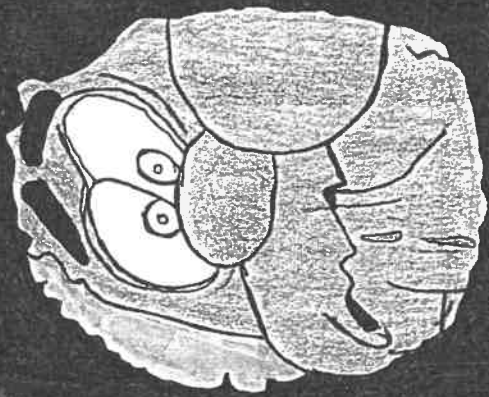
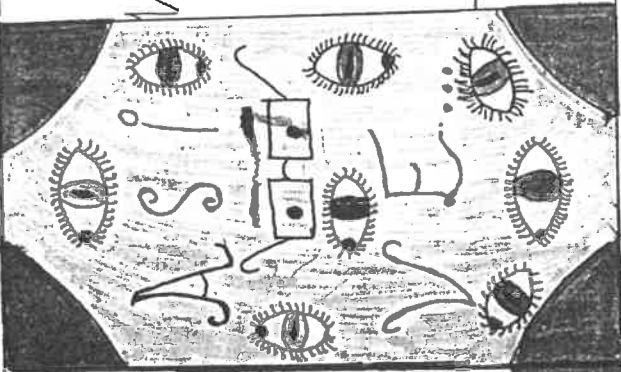

O venime da mazá.

O que se olvidou pagar o recibo da luz.

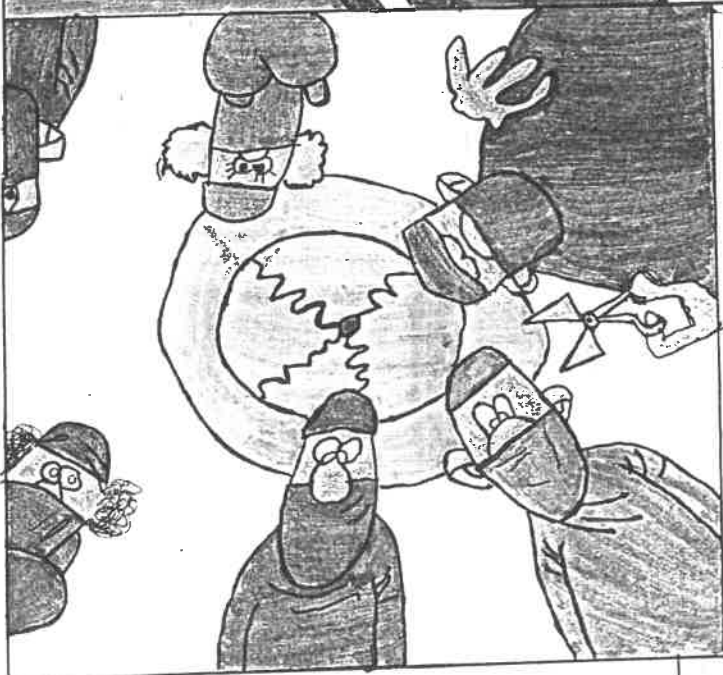

O que se liou a santar diante do cartel que decía 'Silencio, peligro de aludes de nevad'.

O que alcanzou os 250 km/h. coa moto.

O que colleu aqueles reloxos suízos sen pagalos.

