

PRIMER TRIMESTRE
Unidad 1. Matemáticas

ADI

Nombre y apellidos:

Curso: Fecha:

 Repasa con colores y cuenta.

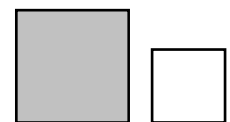
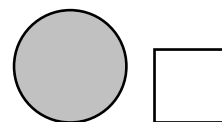
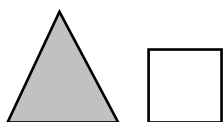
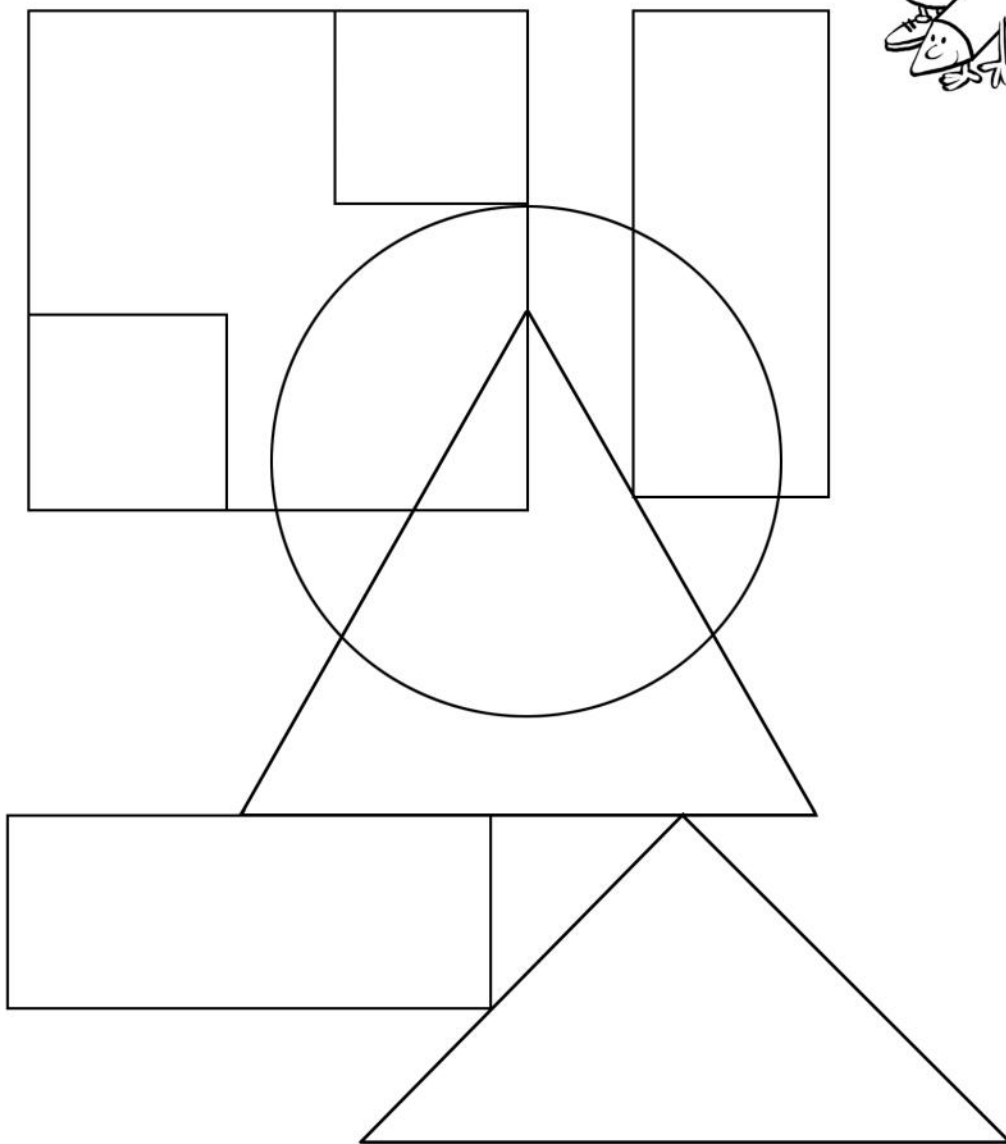
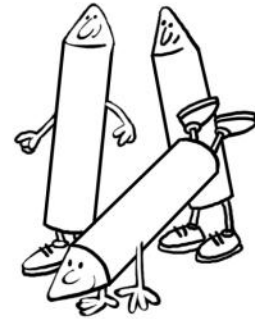

PRIMER TRIMESTRE
Unidad 2. Matemáticas

ADI

Nombre y apellidos:

Curso: Fecha:

 Colorea según el código.

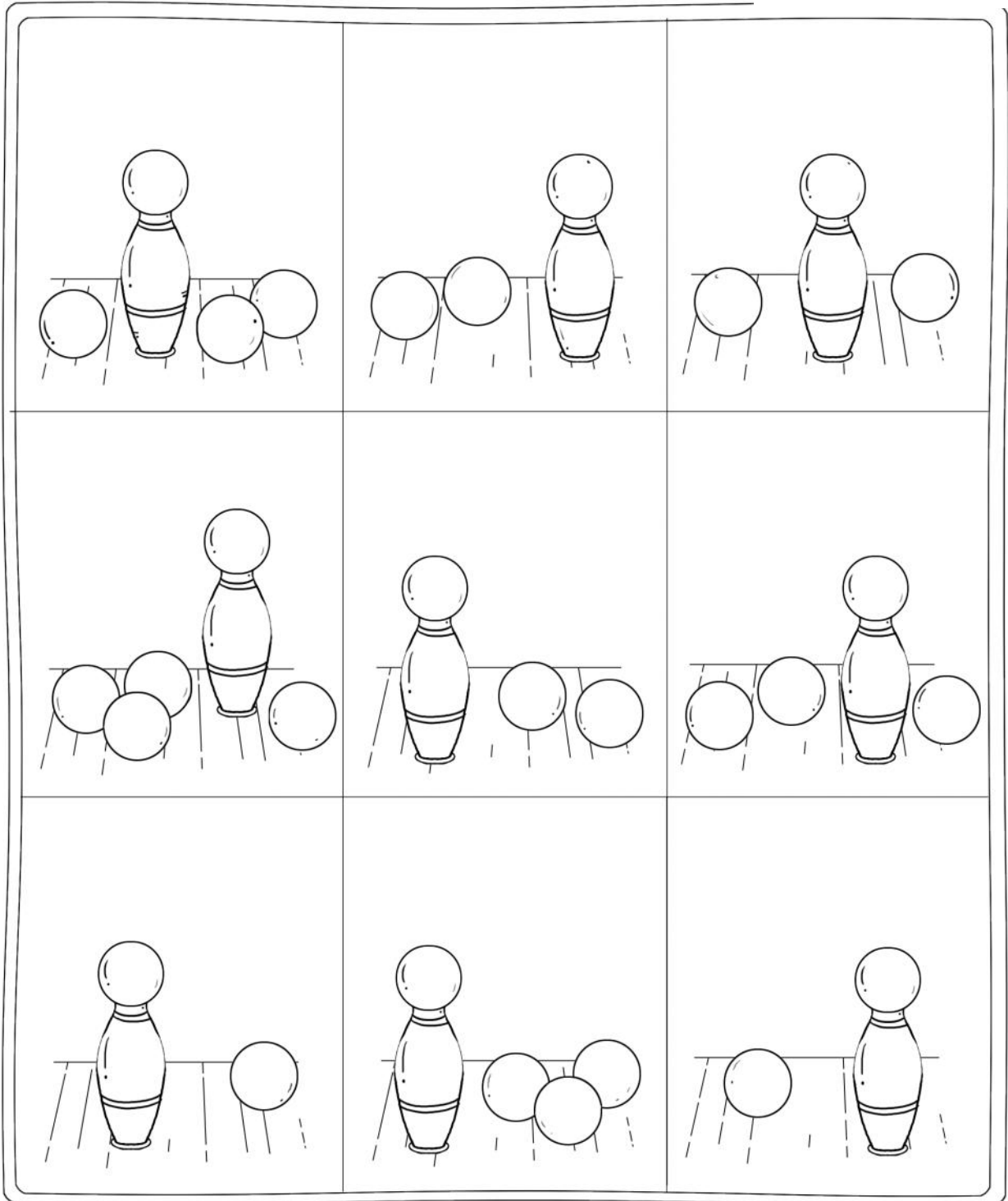

PRIMER TRIMESTRE
Unidad 3. Matemáticas

ADI

Nombre y apellidos:

Curso: Fecha:

 Colorea de marrón los ratones que están dentro.

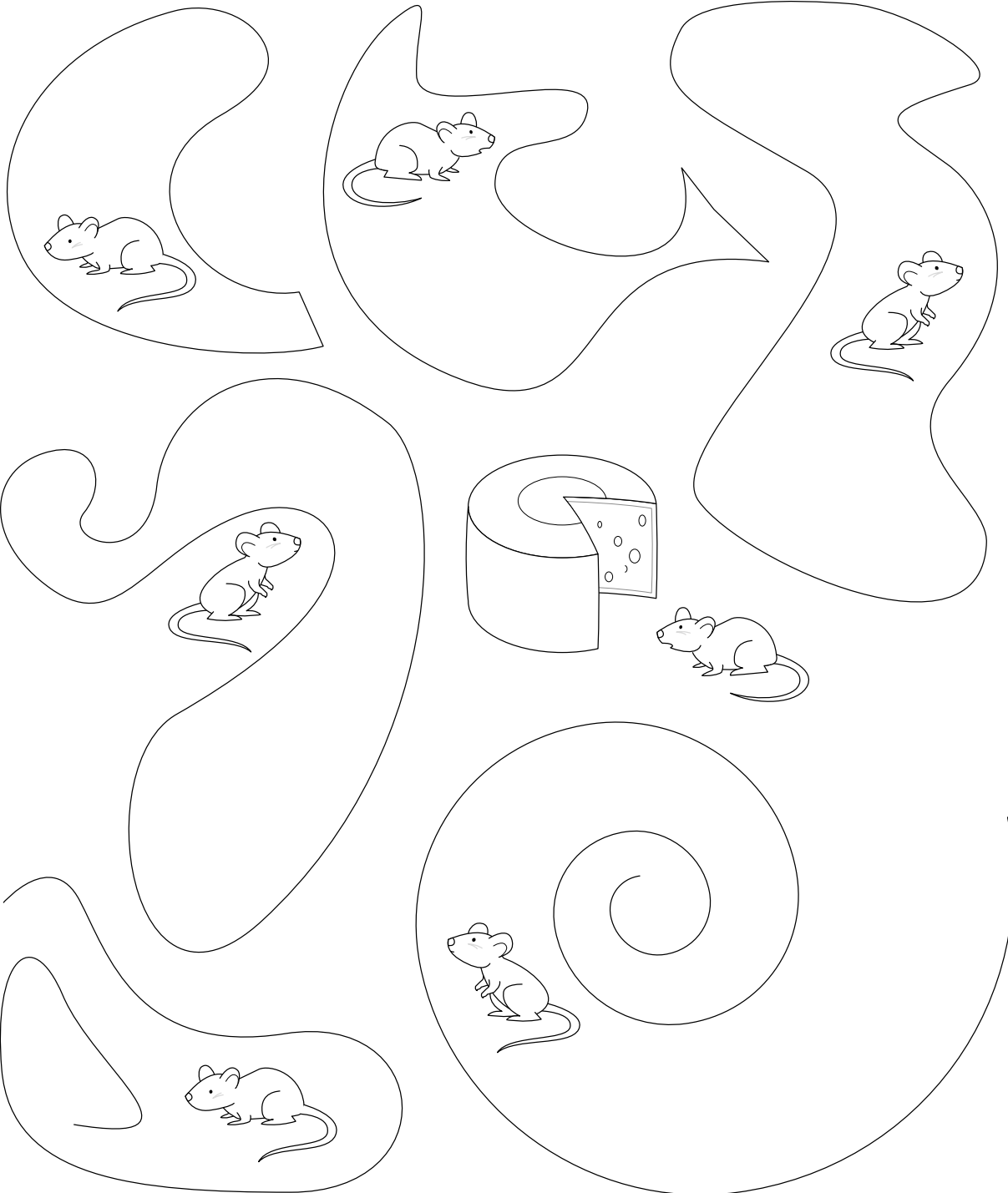

PRIMER TRIMESTRE
Unidad 4. Matemáticas

ADI

Nombre y apellidos:

Curso: **Fecha:**

 Colorea igual los peines que tienen el mismo número de púas.

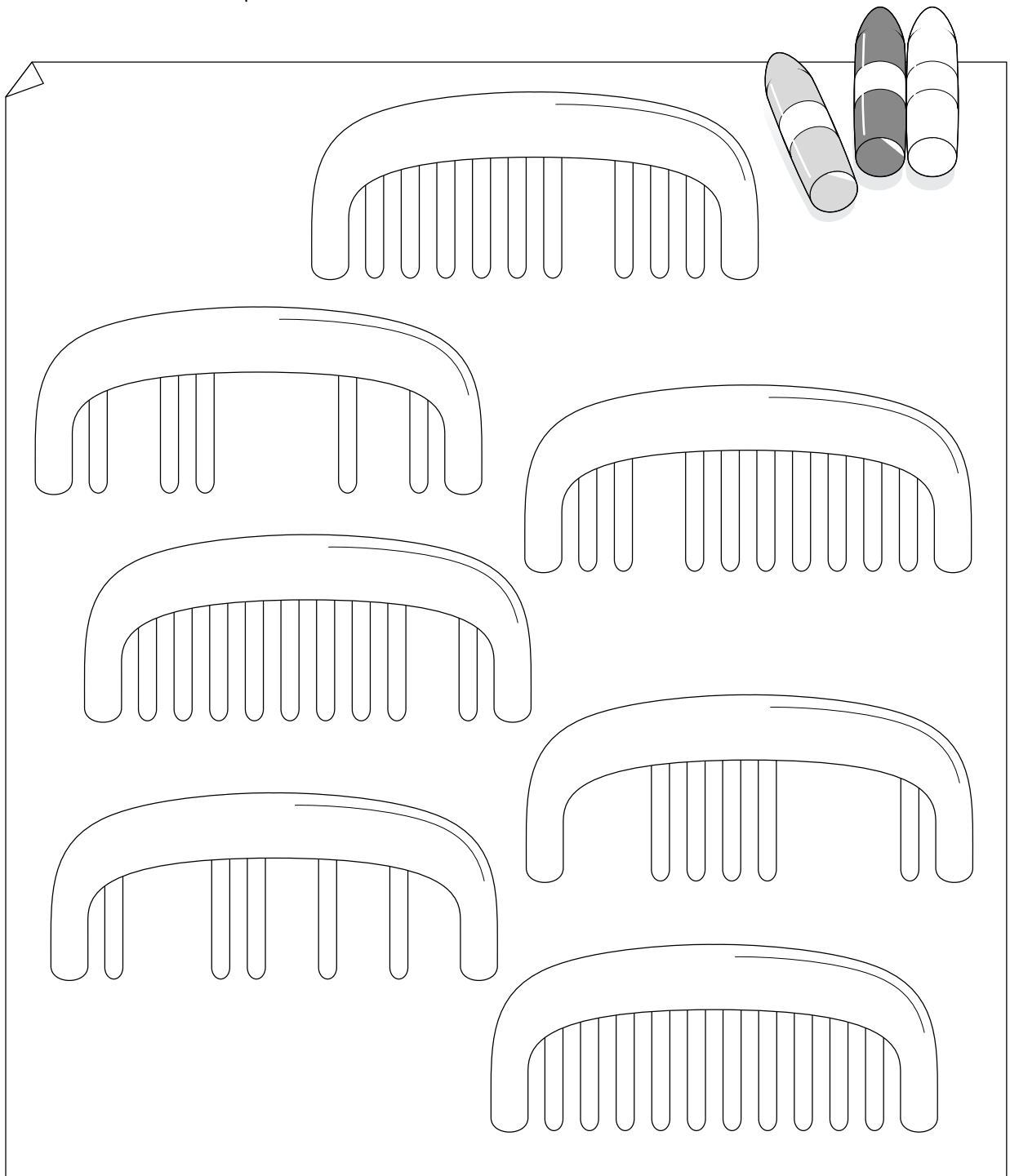

The activity area contains eight combs arranged in two columns. The top comb has 12 teeth. The second row has two combs: the left one has 4 teeth and the right one has 12 teeth. The third row has two combs: the left one has 12 teeth and the right one has 4 teeth. The bottom row has two combs: the left one has 4 teeth and the right one has 12 teeth. To the right of the combs are three markers: a grey one, a dark grey one, and a white one.

PRIMER TRIMESTRE
Unidad 5. Matemáticas

ADI

Nombre y apellidos:

Curso: Fecha:

 *Dibuja igual.*

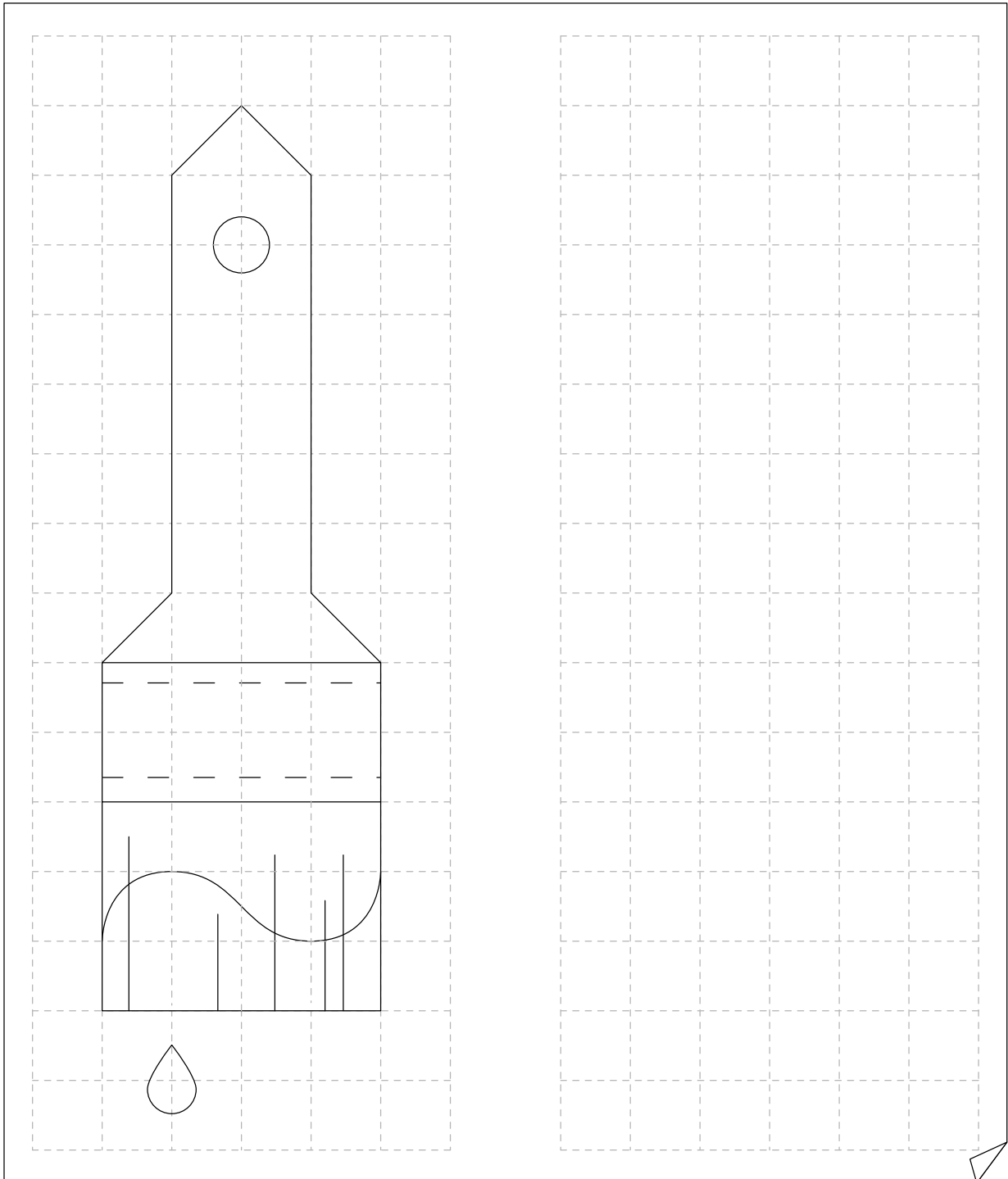

SEGUNDO TRIMESTRE
Unidad 1. Matemáticas

ADI

Nombre y apellidos:

Curso: Fecha:

 Busca, repasa los animales y coloréalos.

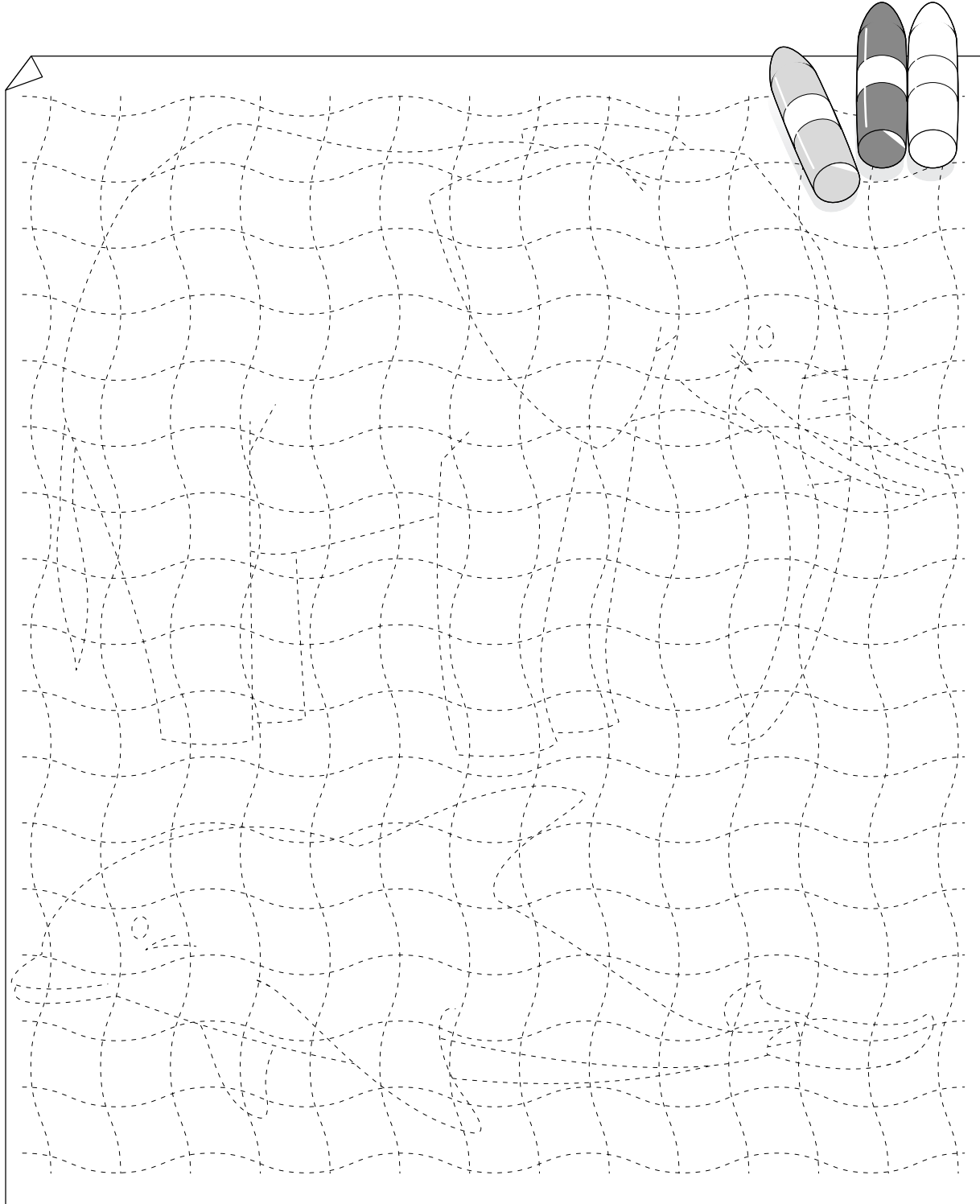

SEGUNDO TRIMESTRE

Unidad 2. Matemáticas

ADI

Nombre y apellidos:

Curso: Fecha:

 Une los objetos que sean iguales.

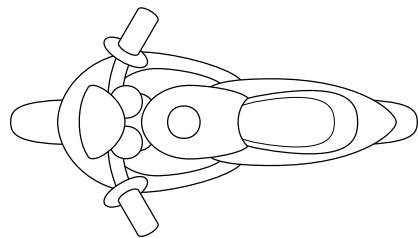
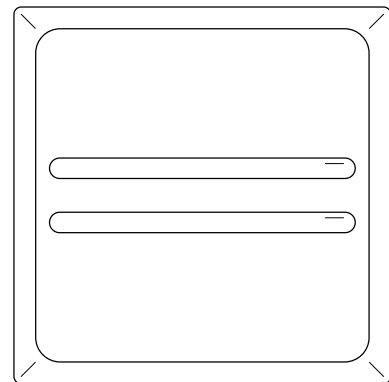
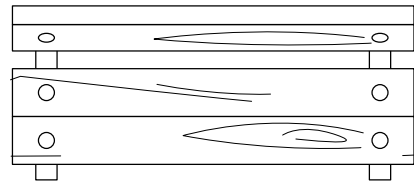
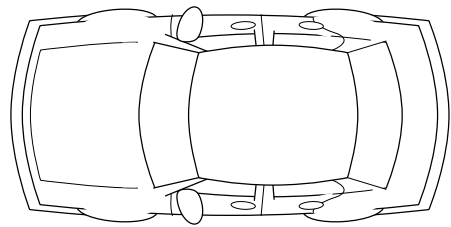
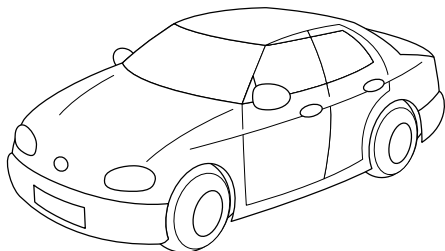
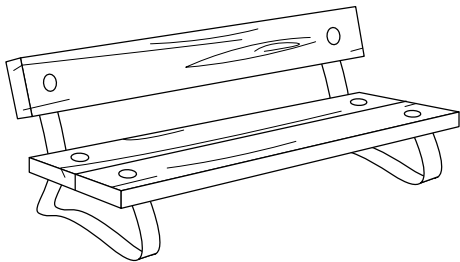
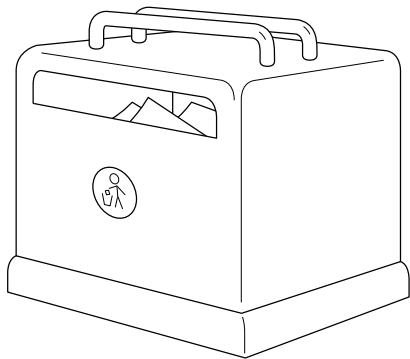
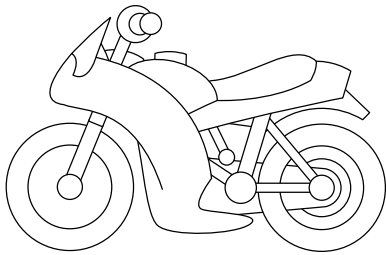

SEGUNDO TRIMESTRE

Unidad 3. Matemáticas

ADI

Nombre y apellidos:

Curso: Fecha:

 Busca y señala 7 diferencias.

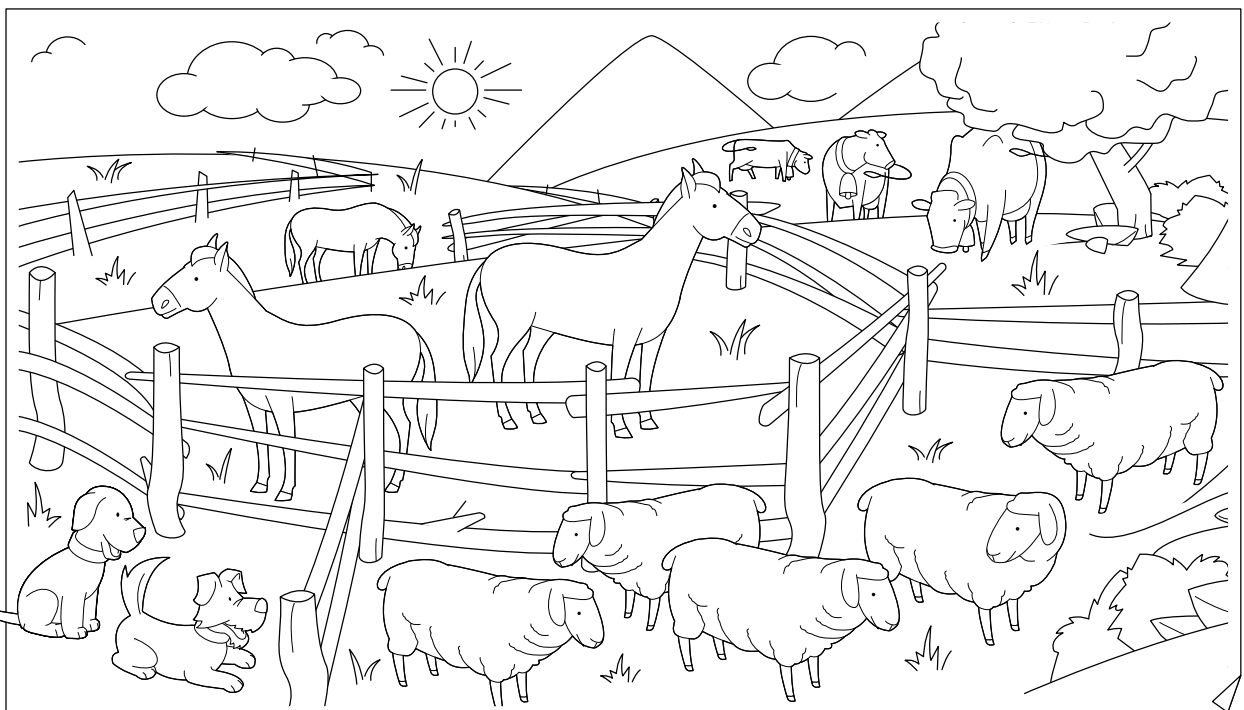
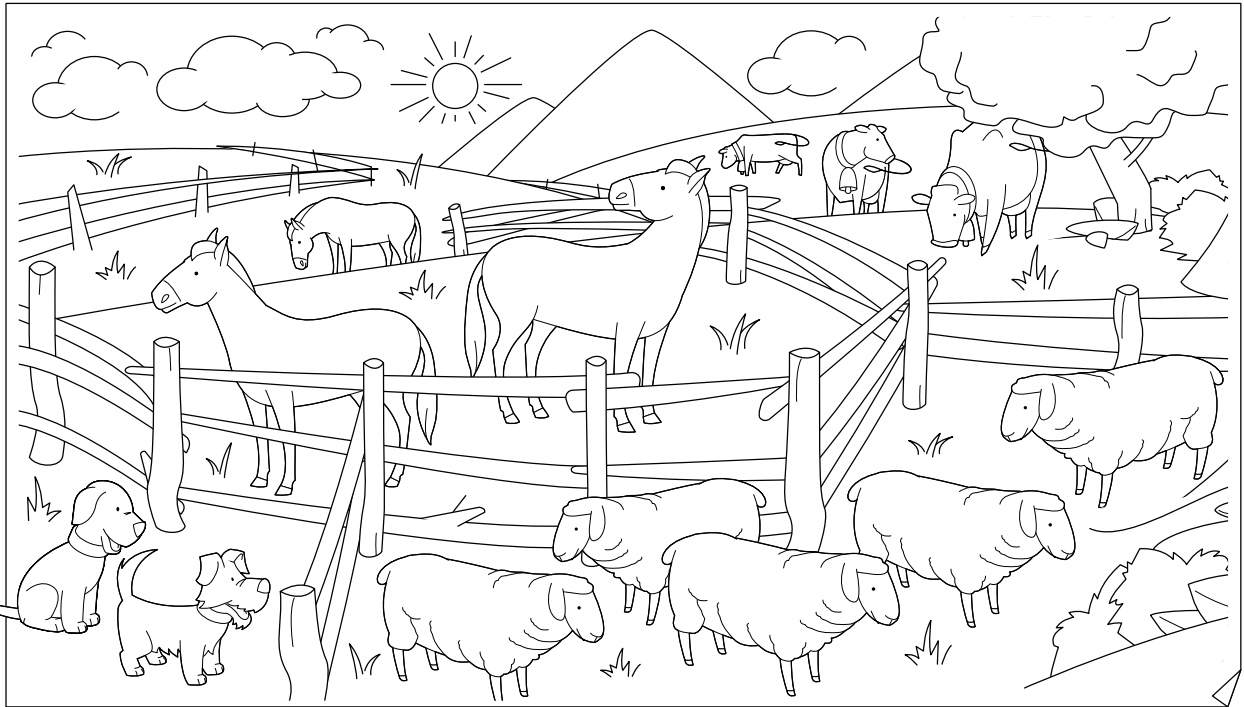

SEGUNDO TRIMESTRE

Unidad 4. Matemáticas

ADI

Nombre y apellidos:

Curso: Fecha:

 Completa las series.

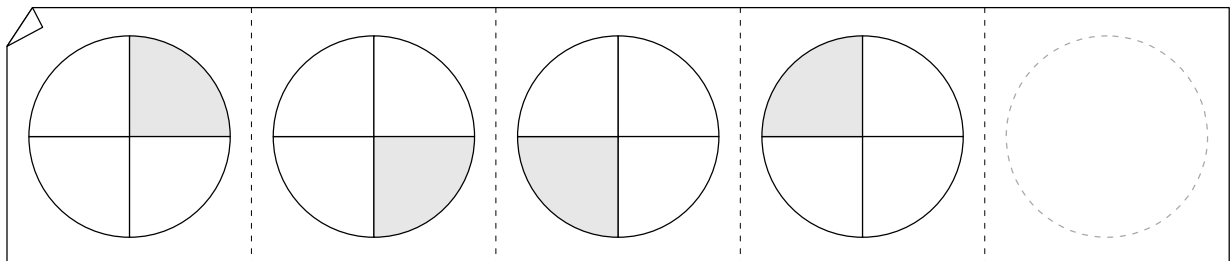
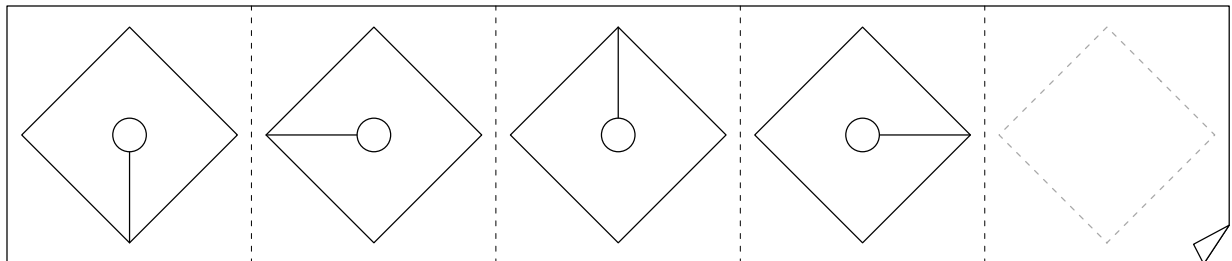
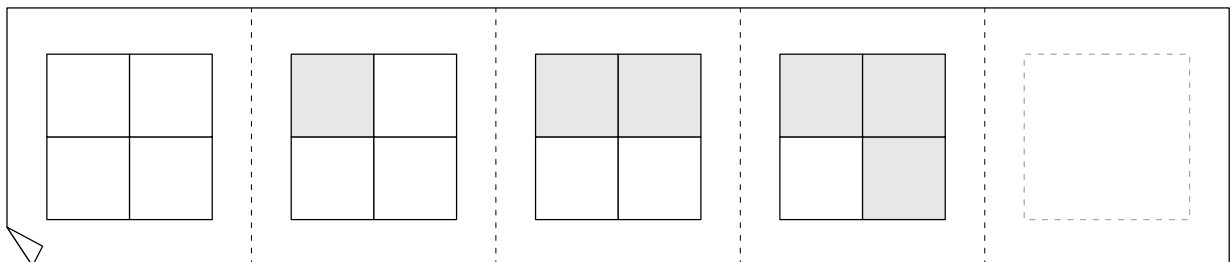
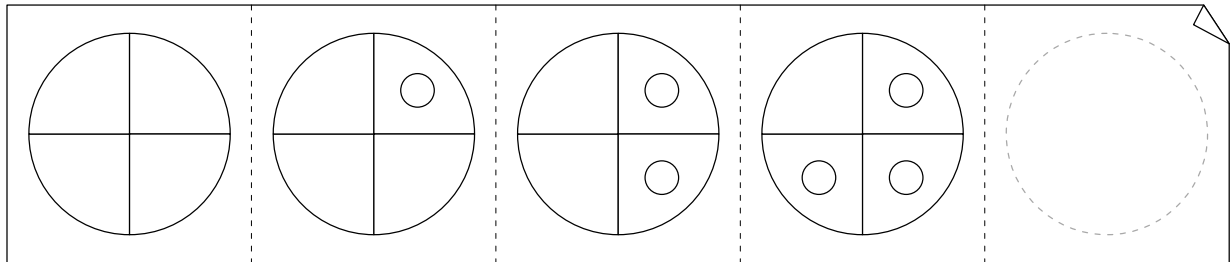
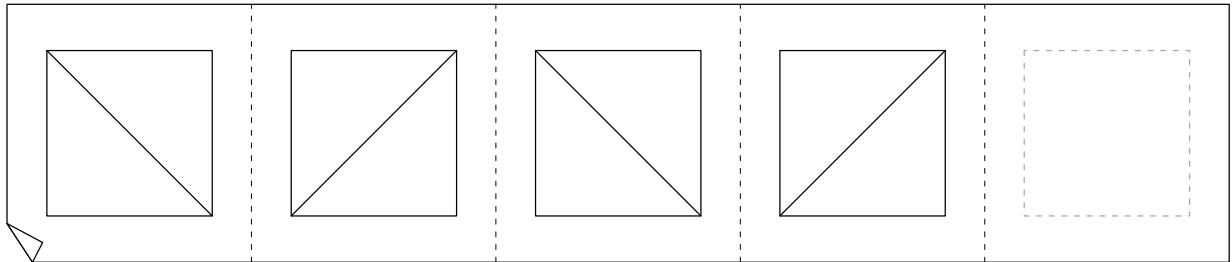

SEGUNDO TRIMESTRE

Unidad 5. Matemáticas

ADI

Nombre y apellidos:

Curso: Fecha:

 Tacha lo que no tenga relación.

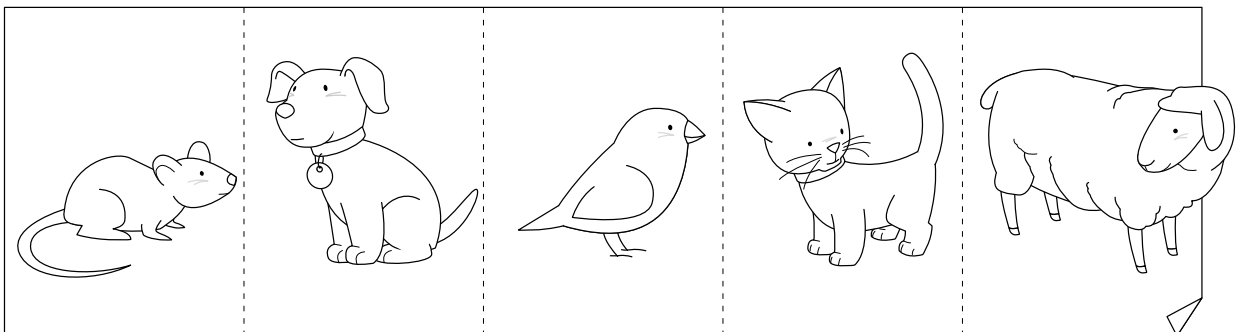
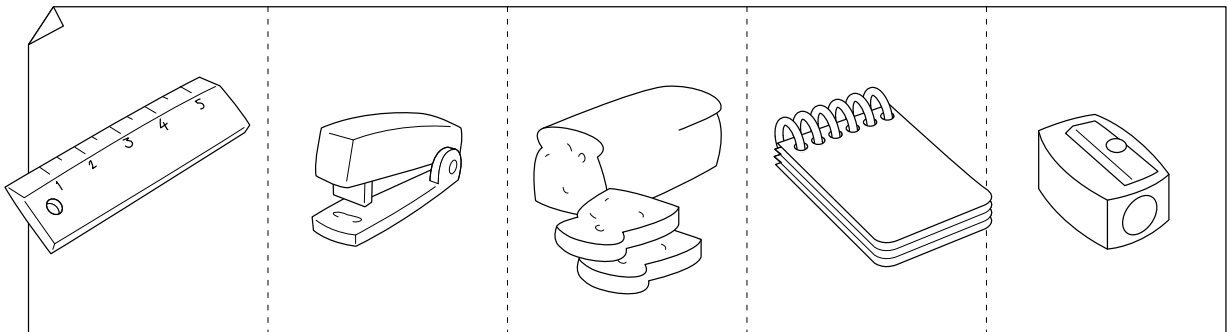
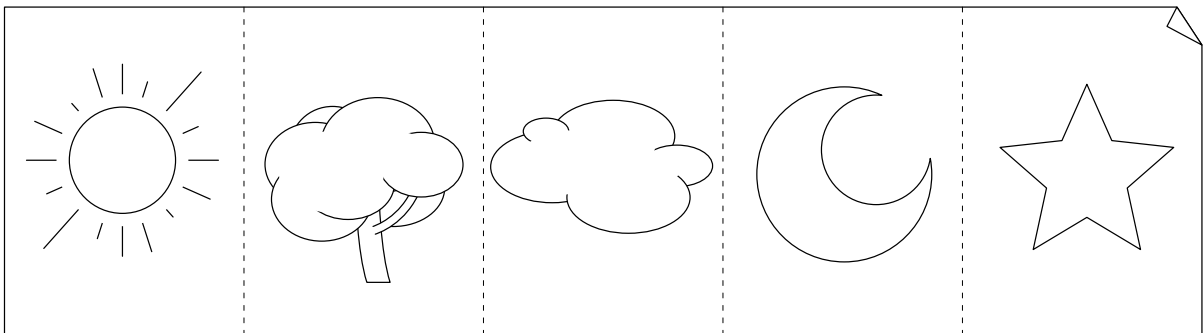
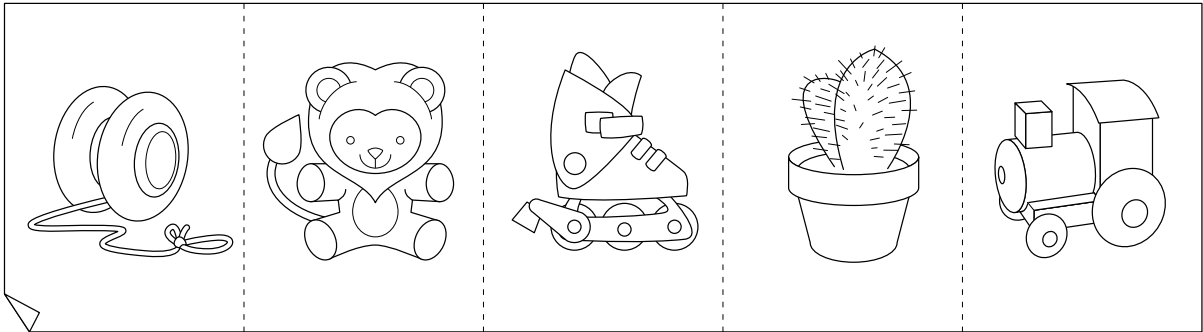

TERCER TRIMESTRE
Unidad 1. Matemáticas

ADI

Nombre y apellidos:

Curso: Fecha:

 Busca las tres piezas iguales y coloréalas.

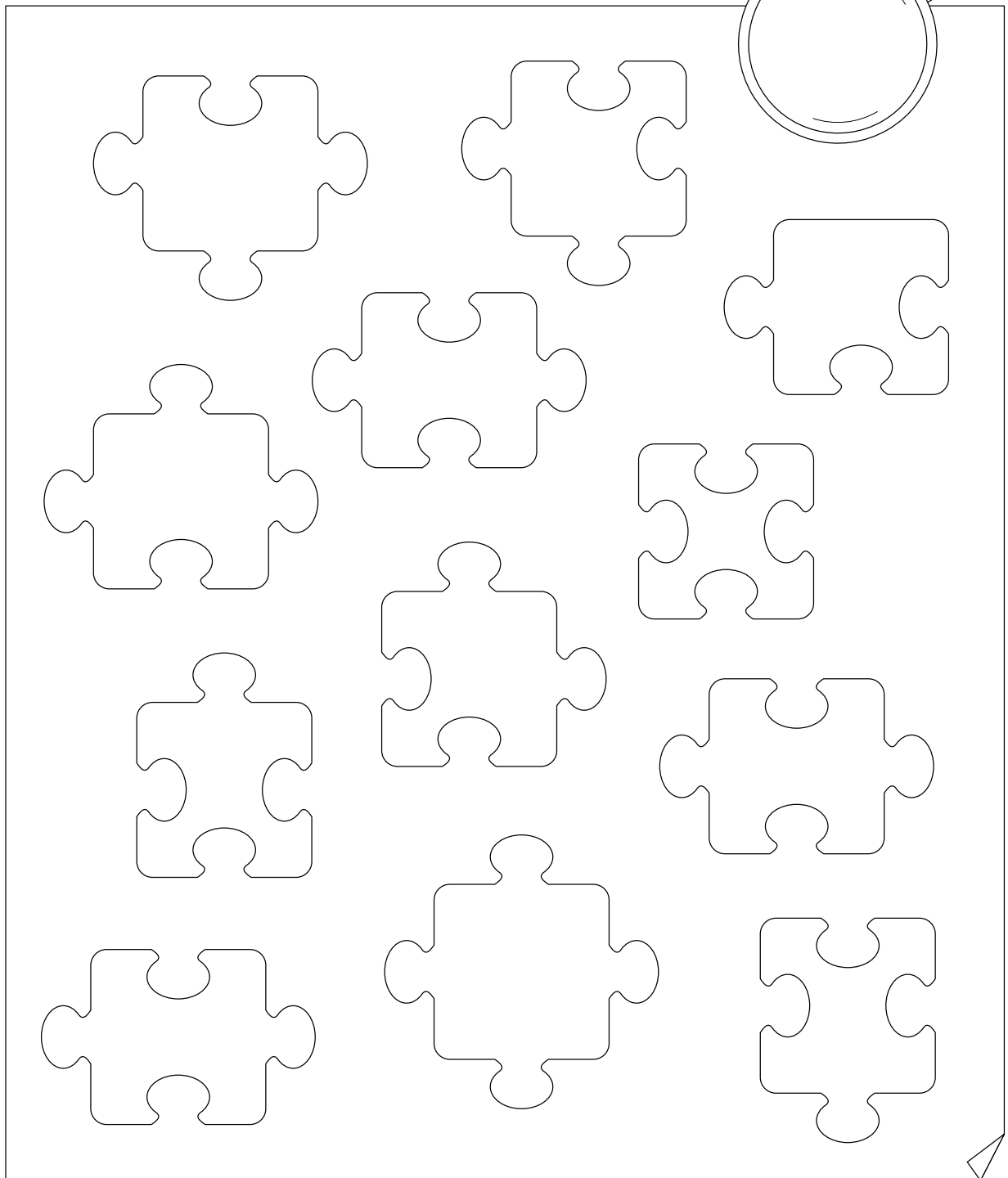

TERCER TRIMESTRE

Unidad 2. Matemáticas

ADI

Nombre y apellidos:

Curso: Fecha:

 Recorta las viñetas y pégalas en orden.

1.º	2.º
3.º	4.º

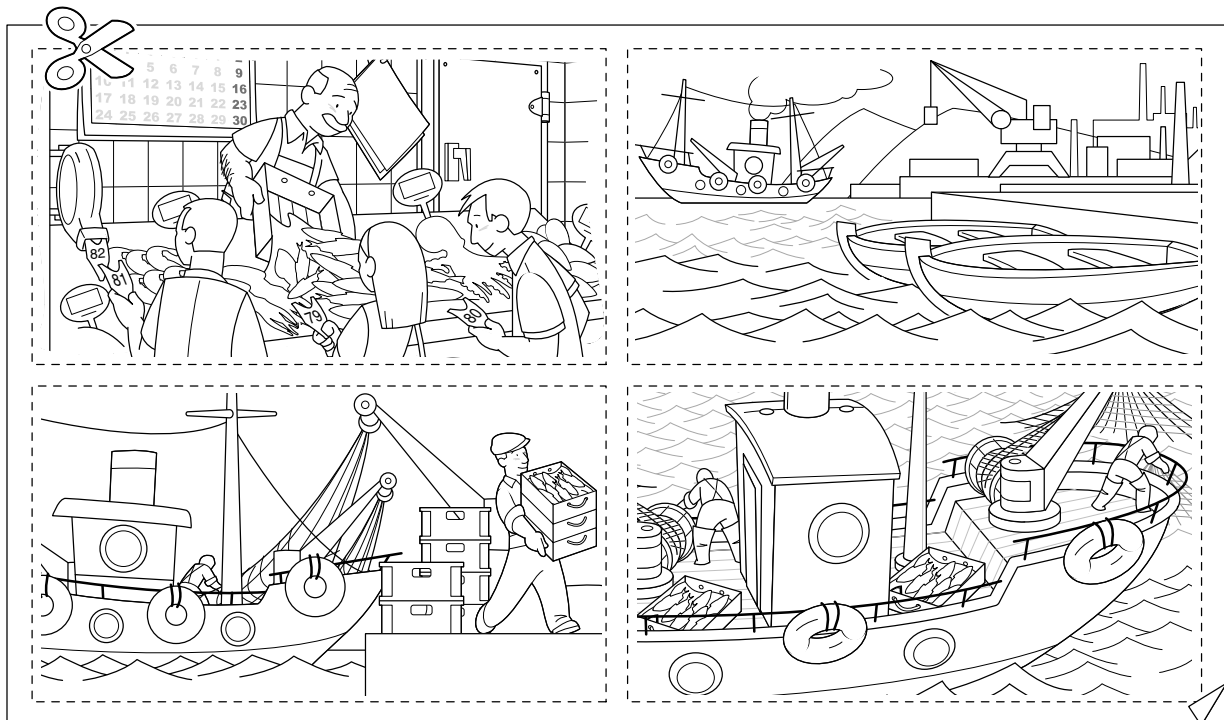

TERCER TRIMESTRE

Unidad 3. Matemáticas

ADI

Nombre y apellidos:

Curso: Fecha:

 Busca la secuencia y continúa las series.

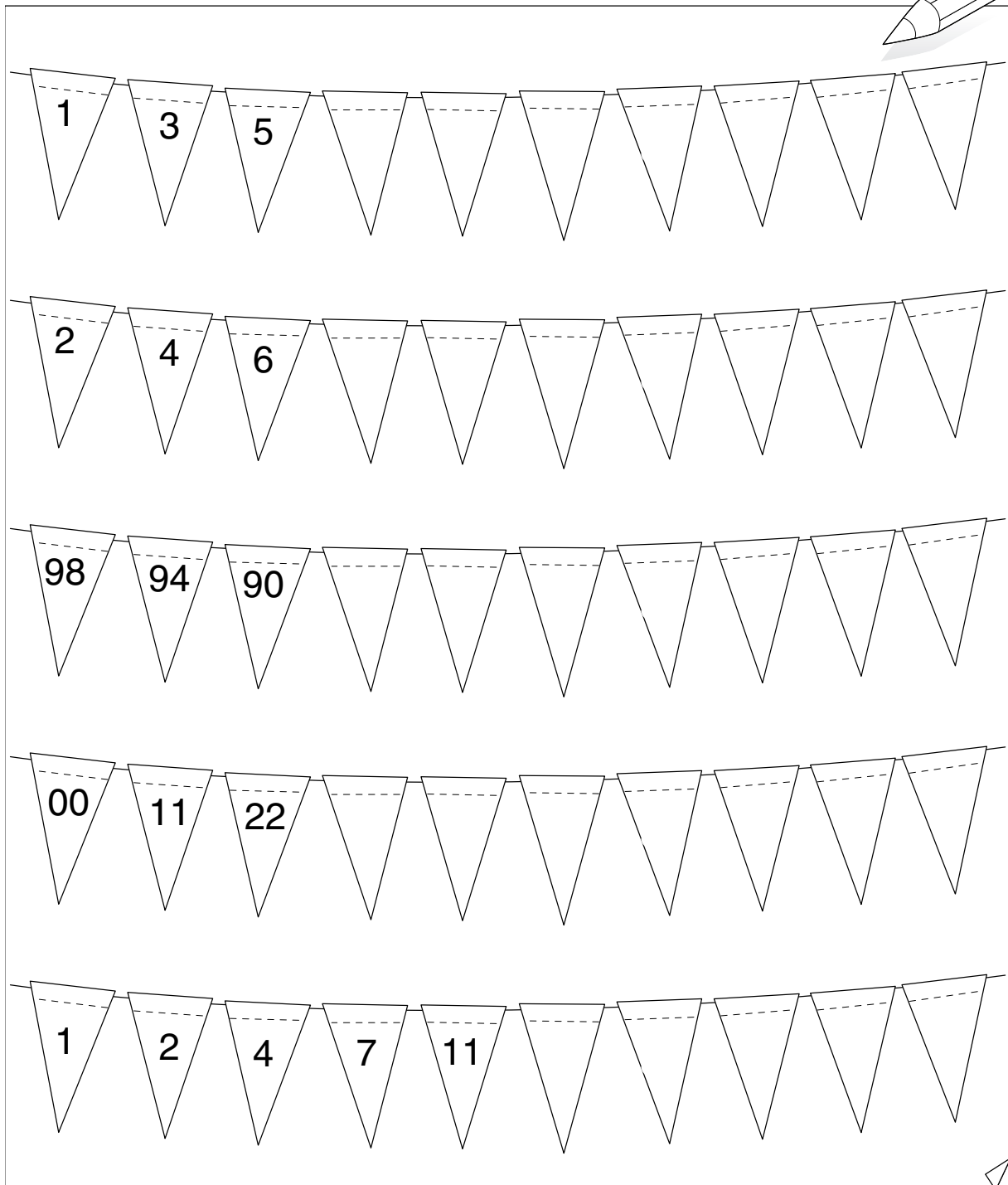

1 3 5

2 4 6

98 94 90

00 11 22

1 2 4 7 11

TERCER TRIMESTRE

Unidad 4. Matemáticas

ADI

Nombre y apellidos:

Curso: Fecha:

 Recorta las figuras y pégalas en su sitio.

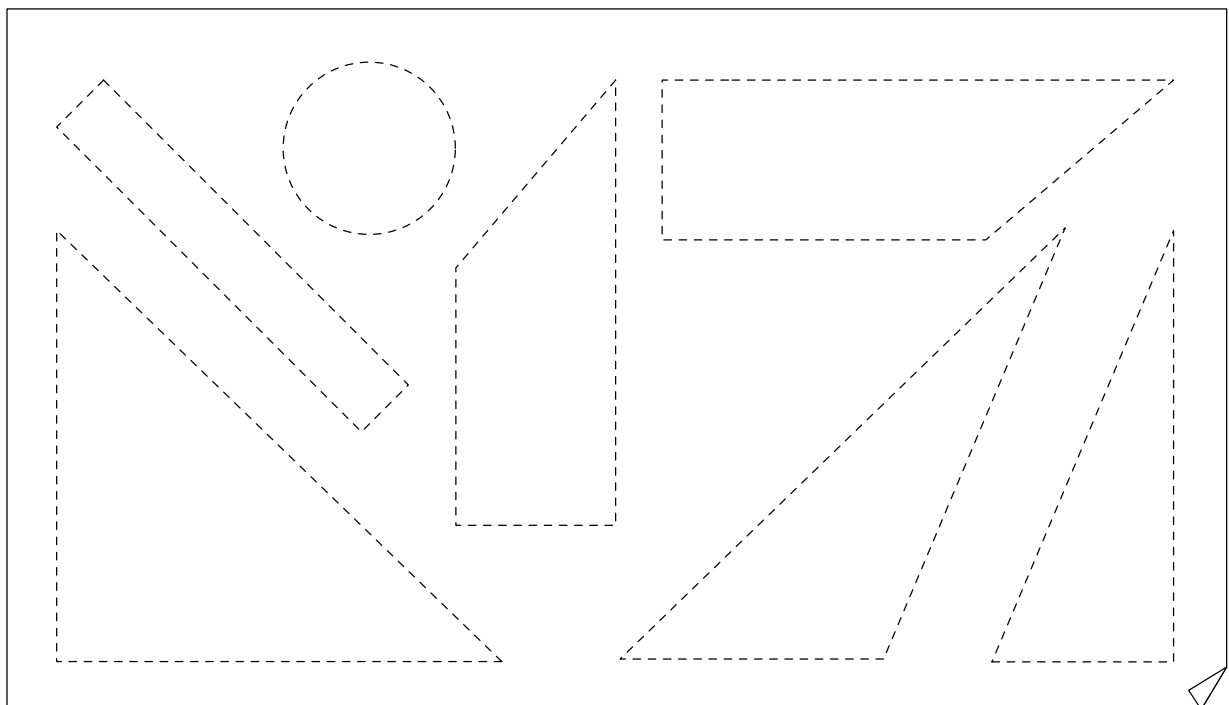
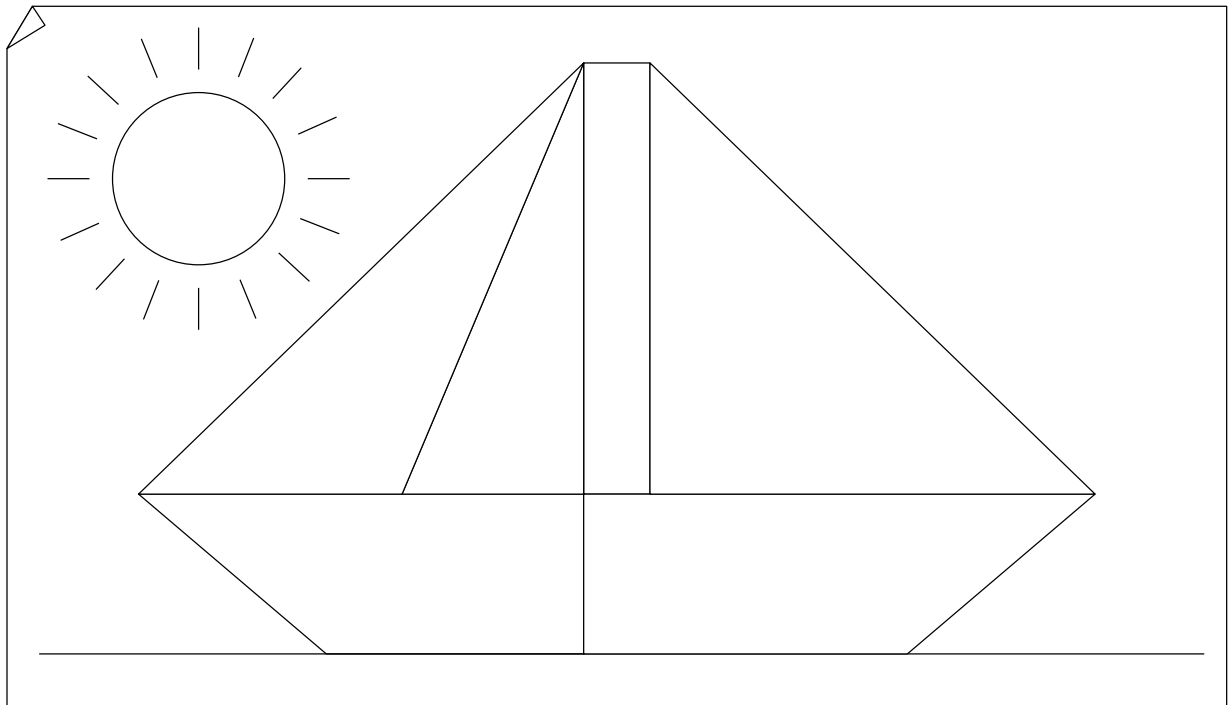

TERCER TRIMESTRE

Unidad 5. Matemáticas

ADI

Nombre y apellidos:

Curso: Fecha:

 Une las partes que componen estos objetos:

