

CROSSCURRICULAR 1

3th B 16th-29th March 2020

Label. Read and colour. Cut out and stick.



bird flower grass leaves snake spider

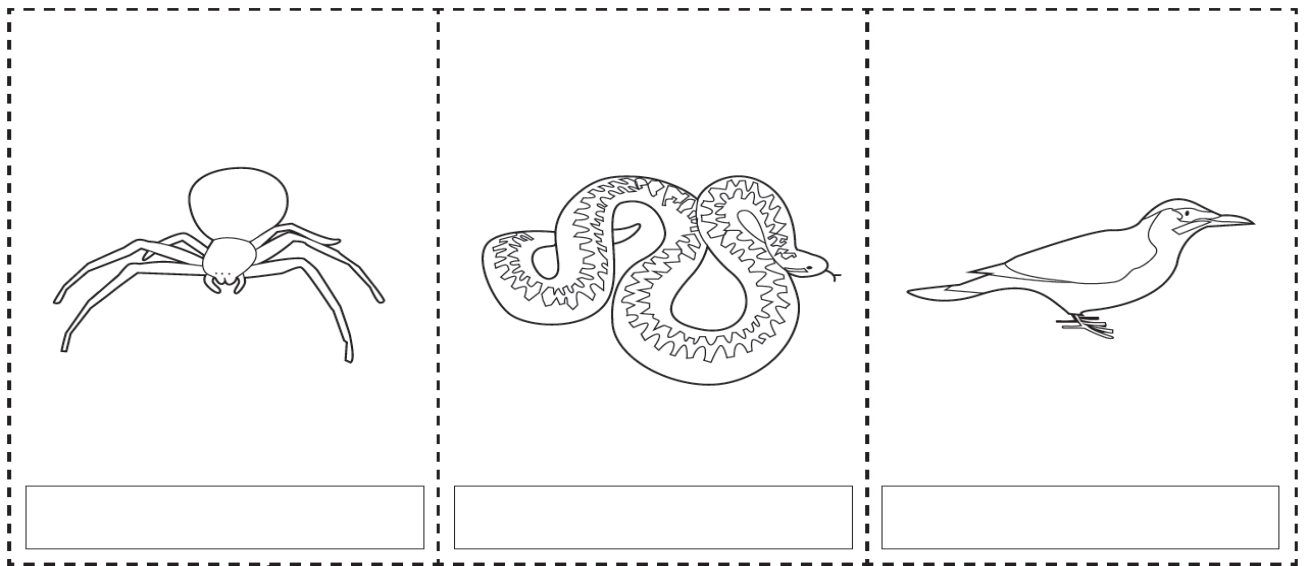
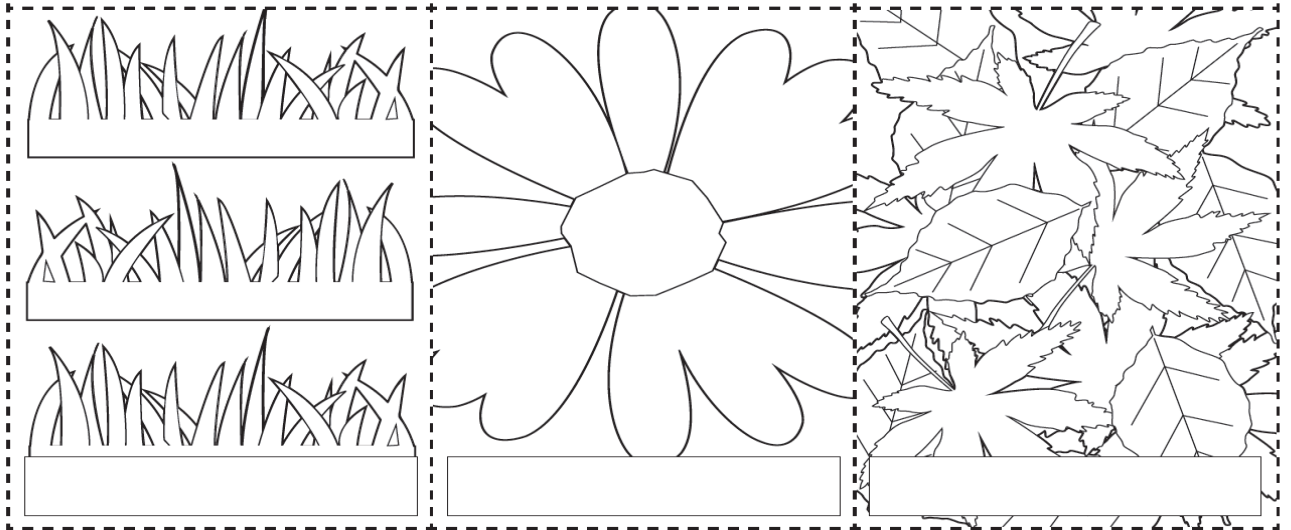

The snake is brown and black. It hides in the leaves. The leaves are brown. The snake is difficult to see.

The spider is yellow. It's in a flower. The flower is yellow. The spider is difficult to see.

The bird is green. It's in the grass. The grass is green. The bird is difficult to see.

CROSSCURRICULAR 2

3th B 16th-29th March 2020

Read, choose and tick ✓. Draw your castle.

My castle is on  a hill  a rock .

It's got 4 5 6  towers.

It's got  a moat.

 thick walls.

 beautiful gardens.

 a bridge.

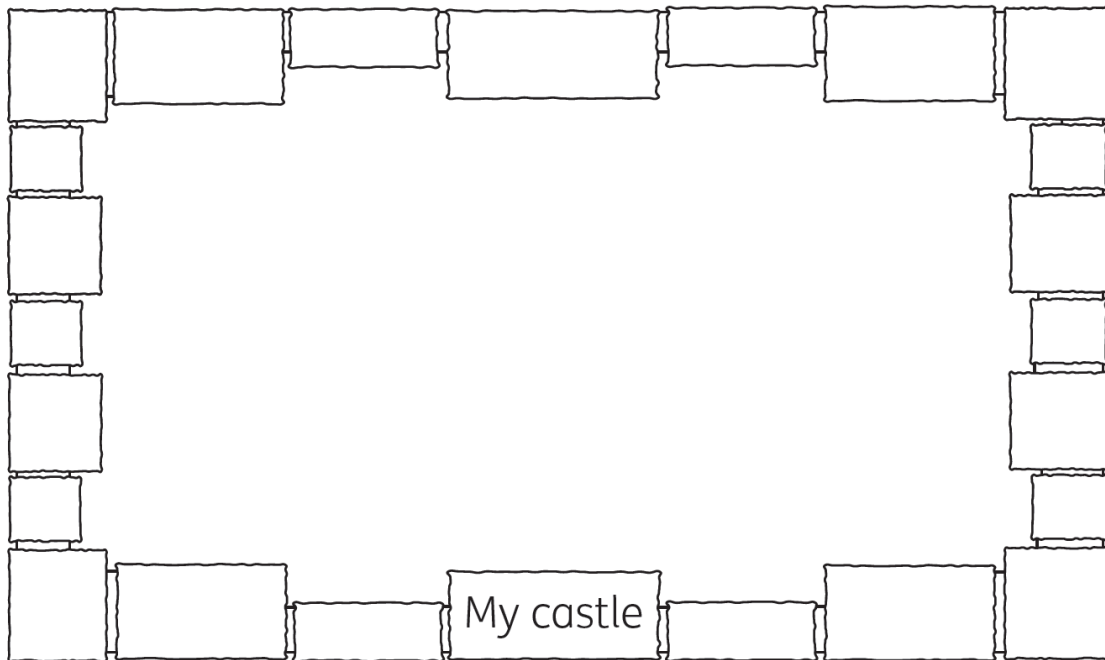

Read and match. Make an instrument.

1 This is a wind instrument. You play it with your mouth. Make it with bottles and water.

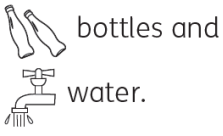

2 This is a string instrument. You play it with your hands. Make it with a pot and rubber bands.

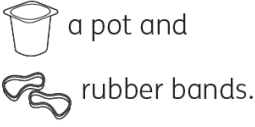

3 This is a percussion instrument. You play it with your hands. Make it with a pot, a balloon, and tape.

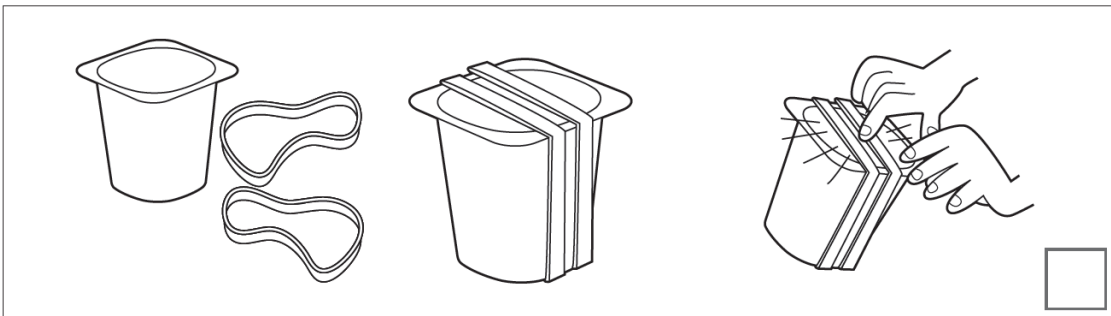
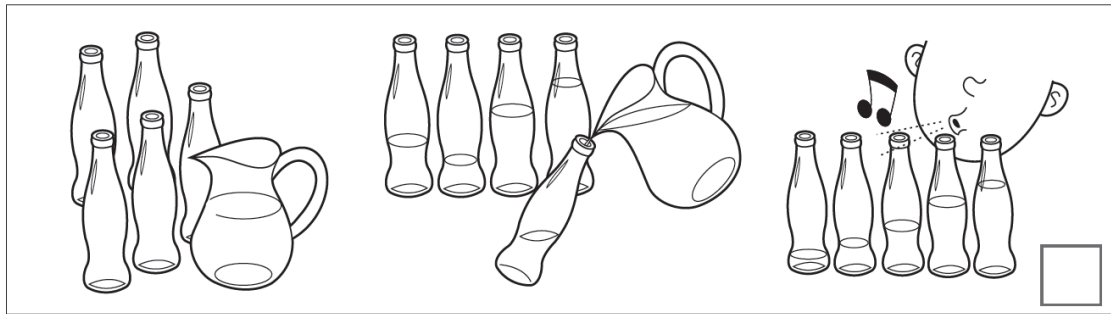
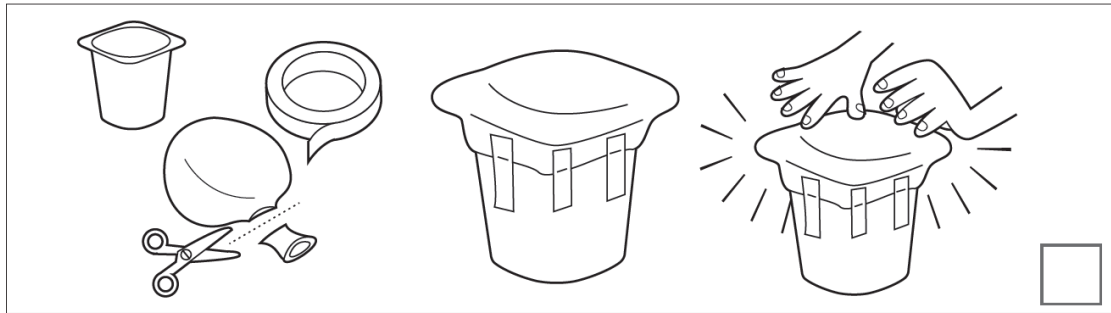
Cut. Read and stick.

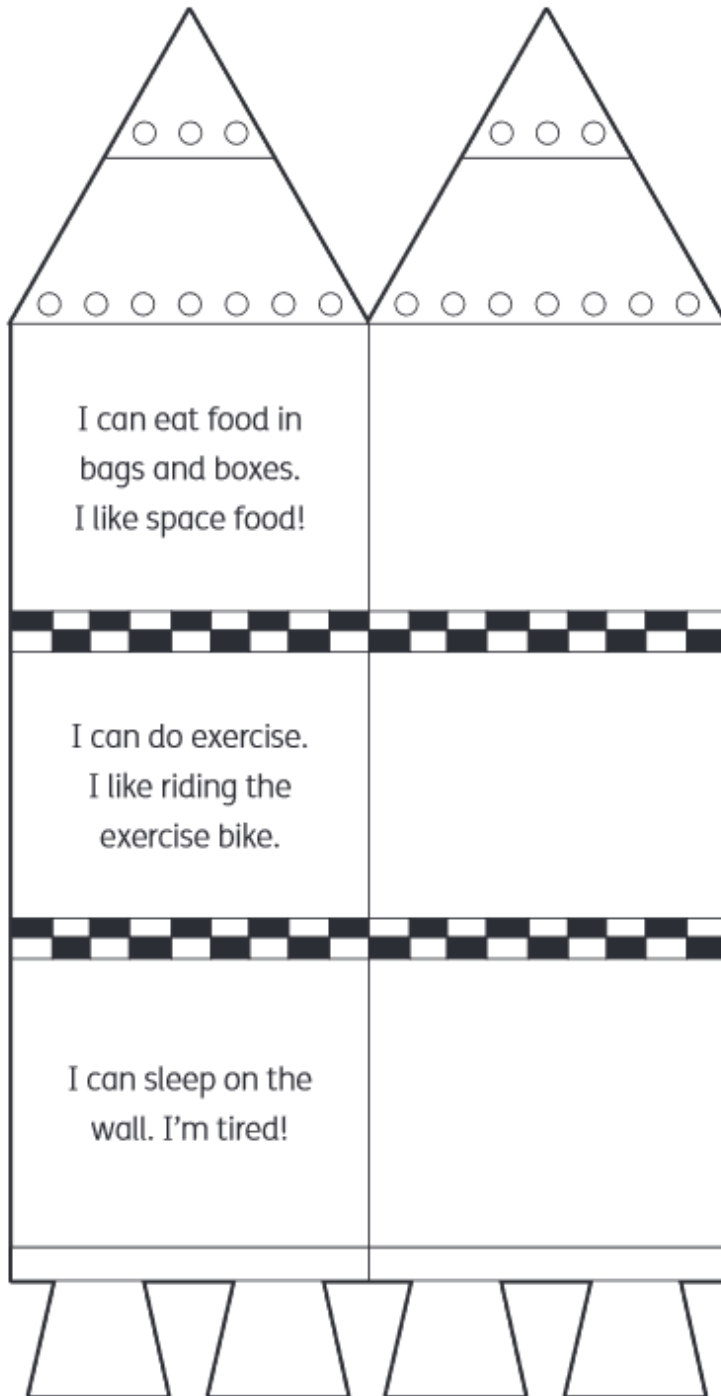

WORKSHEET 1

3th B 16th-29th March 2020

1 Write the numbers in order. Match.

eighty fifty forty ninety one hundred seventy sixty ~~ten~~ thirty ~~twenty~~

ten _____
twenty _____

a 20 b 100 c 40
d 50
e 60 f 90 g 10
h 30 i 80 j 70

2 Write.

retsis ynrgan umm yabb add ~~addnarg~~ erthorb

1 grandad _____
2 _____
3 _____
4 _____

5 _____
6 _____
7 _____

WORKSHEET 2







3th B 16th-29th March 2020

1 Match.

a	$16 + 7 =$	twenty-two
b	$12 + 13 =$	twenty-five
c	$19 + 8 =$	twenty-three
d	$15 + 14 =$	twenty-seven
e	$11 + 10 =$	twenty-one
f	$18 + 6 =$	twenty-six
g	$13 + 9 =$	twenty-nine
h	$16 + 12 =$	twenty-four
i	$11 + 15 =$	twenty-eight

2 Write.

kite bike ball phone car doll ~~book~~ dog

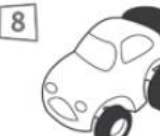
1 	2 	3 	2 1 b a o k	4
4 	5 	6 	3	e
7 	8 	6 5 d	8	a

WORKSHEET 3

3th B 16th-29thMarch2020

1 Colour.

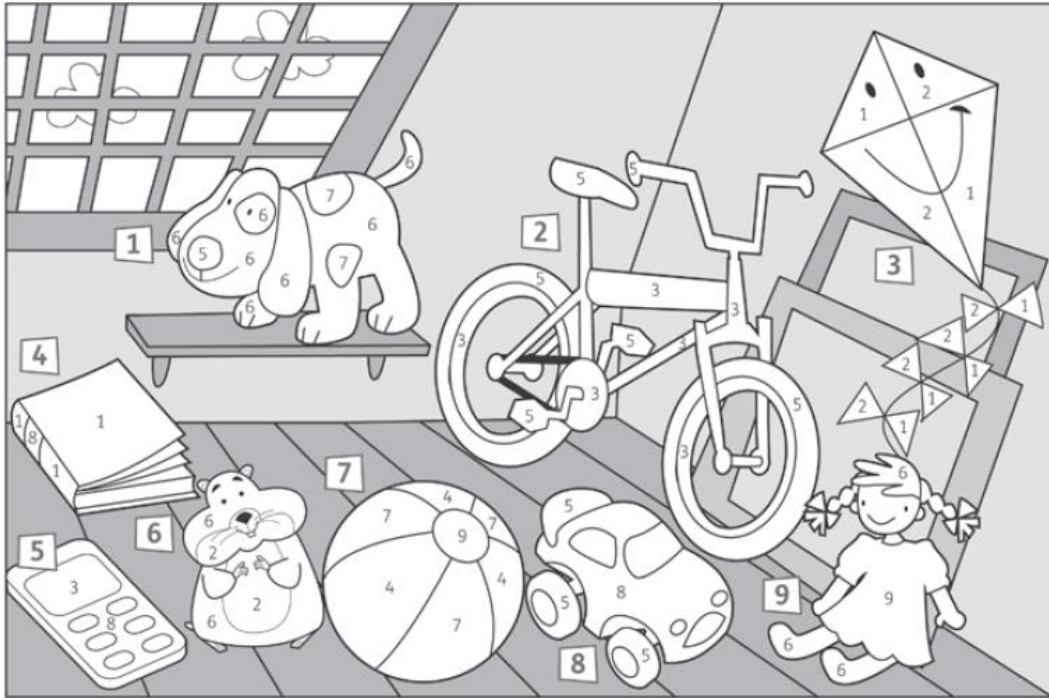

1 = red 2 = yellow 3 = blue 4 = green 5 = black
 6 = brown 7 = purple 8 = orange 9 = pink

2 Colour the toys. Write.

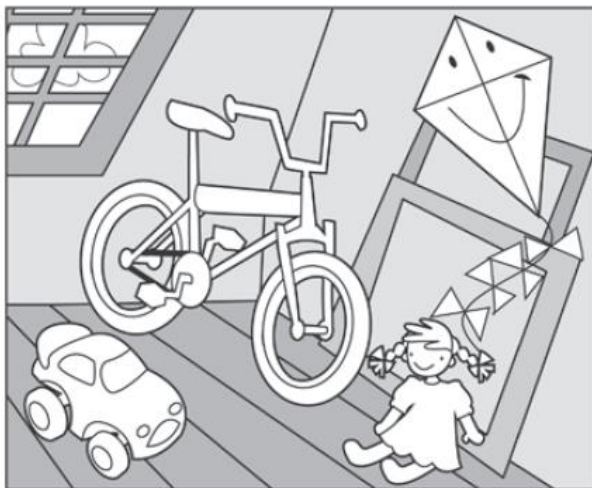

- 1 It's a kite _____
 It's _____
- 2 It's a _____
 It's _____
- 3 _____
 It's _____
- 4 _____
 It's _____

WORKSHEET 4

3th B 16th-29th March 2020

1 Find and write.

crocodile flamingo giraffe gorilla lion zebra

- 1 What's this? _____
- 2 What's this? _____
- 3 What's this? It's a flamingo.
- 4 What's this? _____
- 5 What's this? _____
- 6 What's this? _____



2 Join the dots. Write Yes, it is or No, it isn't.

1

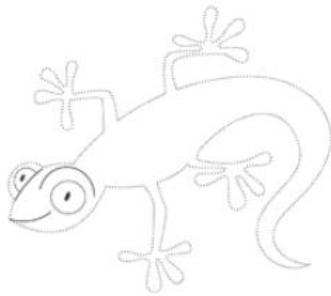

What's this? Is it a lizard?

2



What's this? Is it a flamingo?

3

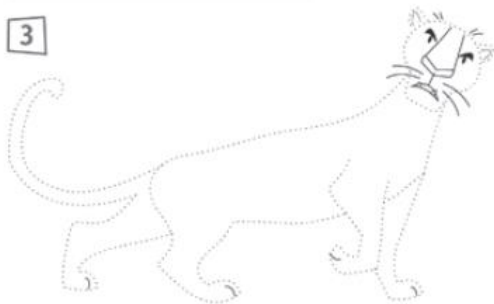

What's this? Is it a panther?

4

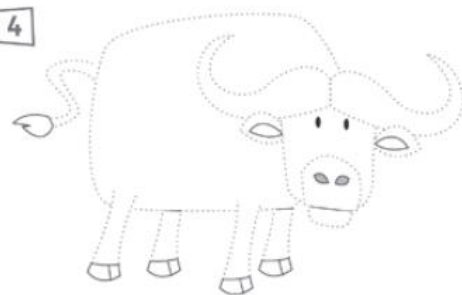

What's this? Is it a lion?

WORKSHEET 5

3th B 16th-29th March 2020

1 Colour. Write.

1 = brown 2 = yellow 3 = green 4 = pink 5 = black 6 = white 7 = blue

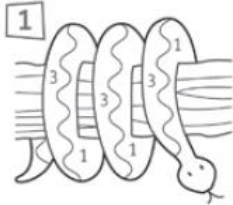

What's this? It's
a green and
brown snake.

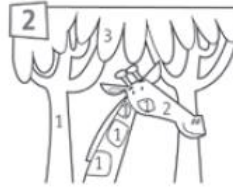

What's this? _____



What's this? _____

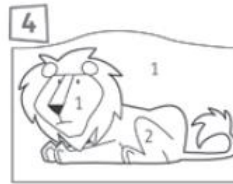

What's this? _____



What's this? _____

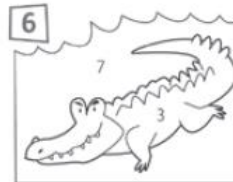

What's this? _____

2 Look and write.



1 What's this?
Is it a tree?



No, it isn't.
It's a

2 What's this?
Is it a plant?



3 What's this?
Is it a river?



4 What's this?
Is it a rock?



WORKSHEET 6

3th B 16th-29thMarch2020

1 Read and tick ✓.

1



I've got a rubber.

I've got a ruler.

2



I've got a folder.

I've got a felt-tip.

3



I've got a calculator.

I've got a sharpener.

4



I've got a felt-tip.

I've got a glue stick.

5



I've got a dictionary.

I've got a notebook.

6



I've got a ruler.

I've got a pencil case.

2 Draw things in your pencil case. Read and write *Yes, I have* or *No, I haven't*.

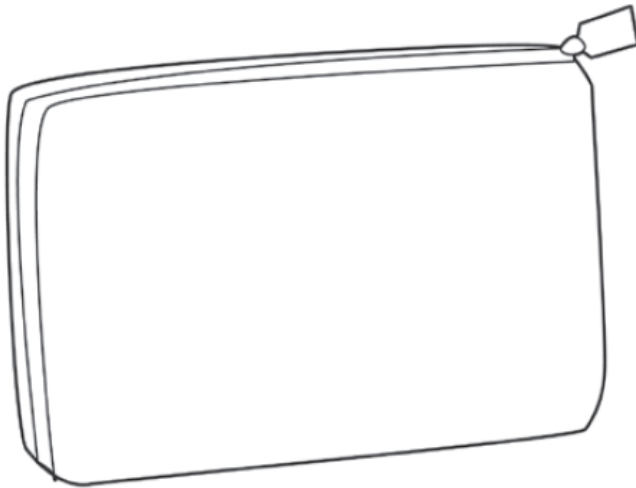

1 Have you got a felt-tip?

2 Have you got a pencil?

3 Have you got a rubber?

4 Have you got a ruler?

5 Have you got a glue stick?

1 Count and write.



I've got five _____ pencils.
_____ pencil cases.
_____ felt-tips.
_____ calculators.
_____ rulers.
_____ pens.
_____ glue sticks.
_____ notebooks.

2 Read and complete.

1 Have you got a pencil?

No, _____
I've got _____

2 Have you got a ruler?

Yes, _____

3 _____
folder?

4 _____
sharpener?

WORKSHEET 8

3th B 16th-29thMarch2020

1 Look and write *I can* or *I can't*.

	Anna	David
	✓	✓
	X	✓
	X	✓
	✓	X
	✓	✓



Anna

I can swim.
 I can't ski.
 _____ surf.
 _____ sail.
 _____ ride a bike.



David

_____ swim.
 _____ ski.
 _____ surf.
 _____ sail.
 _____ ride a bike.

2 Match and write *Yes, I can* or *No, I can't*.

1 Can you play volleyball?



2 Can you skate?



Yes, I can.

3 Can you play football?



4 Can you do karate?



5 Can you dive?



6 Can you play tennis?



WORKSHEET 9

3th B 16th-29thMarch2020

1 Find and write.



She can _____



He can't _____









2 Write the words in order. Answer for you. Write Yes, I can. or No, I can't.

1 karate? Can do you

Can _____

2 you recorder? Can the play

3 a you bike? Can ride

4 play Can the you violin?

5 volleyball? you play Can

6 Can guitar? you the play

1 Read and tick ✓ or cross x.



- 1 Mia likes peaches.
- 2 She likes rice.
- 3 She likes sausages.
- 4 She likes burgers.

- 5 Tom likes soup.
- 6 He likes sandwiches.
- 7 He likes vegetables.
- 8 He likes eggs.

2 Look and write. Answer for you. Write Yes, I do or No, I don't.

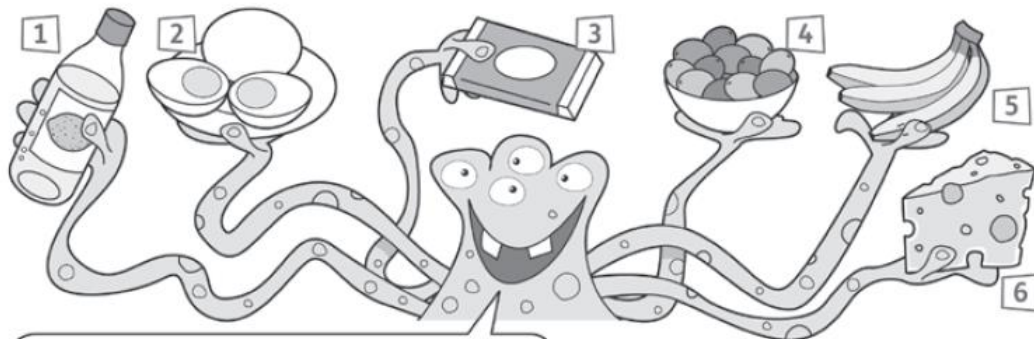

- 1 Do you like lemonade?
- 2 Do you like _____
- 3 Do you like _____
- 4 Do you like _____
- 5 Do you like _____
- 6 Do you like _____
